

# ZOOM 707II GUITAR

## Operation Manual

### CONTENTS

<b>USAGE AND SAFETY PRECAUTIONS</b> .....	<b>2</b>
<b>Introduction</b> .....	<b>3</b>
<b>Controls and Functions</b> .....	<b>4</b>
Top Panel .....	4
Rear Panel .....	4
<b>Preparations</b> .....	<b>6</b>
Inserting Batteries and a SmartMedia card .....	6
Getting Connected .....	7
<b>Quick Guide (Let's Play)</b> .....	<b>8</b>
<b>Listening to Patches (Play Mode Operation)</b> .....	<b>10</b>
Panel Display in Play Mode .....	10
Selecting a Patch .....	10
Using the Tuner Function .....	11
Using the Easy Edit Function .....	12
Using the Sampler Function .....	13
Using the Rhythm Function .....	16
<b>Changing the Sound of a Patch (Edit Mode)</b> .....	<b>18</b>
Patch Configuration .....	18
Basic Edit Mode Steps .....	18
Storing and Swapping Patches .....	20
<b>Other Functions</b> .....	<b>21</b>
Using the Hold Delay Function .....	21
Changing the Patch Call Method .....	23
Using the Pedal to Control an Effect .....	23
Adjusting the Expression Pedal .....	25
Storing Rhythm Patterns and Samples as Part of a Patch .....	26
Assigning a rhythm pattern to a patch .....	26
Assigning a sample to a patch .....	27
Using a SmartMedia card (Utility Mode) .....	28
Basic utility mode operation steps .....	28
Utility mode functions .....	29
All Initialize/Factory Recall .....	32
<b>Effect Types and Parameters</b> .....	<b>33</b>
BOOSTER Module .....	33
ISOLATOR/COMP (Isolator/Compressor) Module .....	33
DRIVE Module .....	33
EQ (Equalizer) Module .....	34
ZNR/D GATE (ZOOM Noise Reduction/D Gate) Module .....	35
CABINET Module .....	35
MODULATION Module .....	35
DLY/REV (Delay/Reverb) Module .....	37
TOTAL Module .....	38
<b>Troubleshooting</b> .....	<b>39</b>
<b>Specifications</b> .....	<b>39</b>
Patch List .....	40

# USAGE AND SAFETY PRECAUTIONS

## SAFETY PRECAUTIONS

In this manual, symbols are used to highlight warnings and cautions for you to read so that accidents can be prevented. The meanings of these symbols are as follows:



This symbol indicates explanations about extremely dangerous matters. If users ignore this symbol and handle the device the wrong way, serious injury or death could result.



This symbol indicates explanations about dangerous matters. If users ignore this symbol and handle the device the wrong way, bodily injury and damage to the equipment could result.

Please observe the following safety tips and precautions to ensure hazard-free use of the 707II.

### • Power requirements



Since power consumption of this unit is fairly high, we recommend the use of an AC adapter whenever possible. When powering the unit from a battery, use only an alkaline type.

### [AC adapter operation]

- Be sure to use only an AC adapter which supplies 9 V DC, 300 mA and is equipped with a "center minus" plug (Zoom AD-0006). The use of an adapter other than the specified type may damage the unit and pose a safety hazard.
- Connect the AC adapter only to an AC outlet that supplies the rated voltage required by the adapter.
- When disconnecting the AC adapter from the AC outlet, always grasp the adapter itself and do not pull at the cable.
- When not using the unit for an extended period, disconnect the AC adapter from the AC outlet.

### [Battery operation]

- Use four conventional IEC R6 (size AA) batteries (alkaline).
- The 707II cannot be used for recharging. Pay close attention to the labelling of the battery to make sure you choose the correct type.
- When not using the unit for an extended period, remove the batteries from the unit.
- If battery leakage has occurred, wipe the battery compartment and the battery terminals carefully to remove all remnants of battery fluid.
- While using the unit, the battery compartment cover should be closed.

### • Environment



Avoid using your 707II in environments where it will be exposed to:

- Extreme temperature
- High humidity or moisture
- Excessive dust or sand
- Excessive vibration or shock

### • Handling



Since the 707II is a precision electronic device, avoid applying excessive force to the switches and buttons. Also take care not to drop the unit, and do not subject it to shock or excessive pressure.

### • Alterations



Never open the case of the 707II or attempt to modify the product in any way since this can result in damage to the unit.

### • Connecting cables and input and output jacks



You should always turn off the power to the 707II and all other equipment before connecting or disconnecting any cables. Also make sure to disconnect all cables and the AC adapter before moving the 707II.

## Usage Precautions

### • Electrical interference

For safety considerations, the 707II has been designed to provide maximum protection against the emission of electromagnetic radiation from inside the device, and protection from external interference. However, equipment that is very susceptible to interference or that emits powerful electromagnetic waves should not be placed near the 707II, as the possibility of interference cannot be ruled out entirely.

With any type of digital control device, the 707II included, electromagnetic interference can cause malfunctioning and can corrupt or destroy data. Care should be taken to minimize the risk of damage.

### • Cleaning

Use a soft, dry cloth to clean the 707II. If necessary, slightly moisten the cloth. Do not use abrasive cleanser, wax, or solvents (such as paint thinner or cleaning alcohol), since these may dull the finish or damage the surface.

Please keep this manual in a convenient place for future reference.

# Introduction

Thank you for purchasing the **ZOOM 707II GUITAR** (subsequently referred to as "*the 707II*"). The 707II is a sophisticated multi-effect processor for guitar with the following attractive features.

- **Versatile effects**

The Variable Architecture Modeling System(VAMS) adapts the internal configuration of the unit to achieve exactly the desired sound. The wide range of choices includes distortion effects, modulation effects such as chorus and flanger, reverb and delay effects, as well as a booster and cabinet simulator. A total of 74 effects are available.

- **120 great sounding patches**

Effect module setting combinations can be stored as patches. The 707II offers 60 patches which can be freely modified by the user, plus 60 preset patches. These settings will let you make great music straight away.

- **Full complement of distortion effects**

33 distortion type effects not only recreate the characteristics of famous guitar amps but also duplicate the sound and operation of renowned compact effects and pedals. Dedicated knobs and keys assure quick and easy operation.

- **Designed for use on stage**

The 707II can be powered from an AC adapter or batteries. With one set of alkaline batteries, the unit will operate continuously for up to 11 hours. The large display showing patch names, and the built-in expression pedal for fine-tuning the sound are great for live performances.

- **Knobs provide direct editing feel**

Various aspects (effect parameters) that control the sound of a module can be directly modified with three handy knobs. The Easy Edit feature lets you tweak the knobs for adjusting parameters also during play. Of course, you can store the results in your own patch.

- **Sampling feature for recording**

A guitar phrase or the signal from an input source such as a CD player can be sampled for up to 6 seconds and stored in the internal memory. When using a 16 MB SmartMedia card, you can record up to 60 samples or 4 minutes of music. A recorded sample can even be played back at a slower speed without altering the pitch. This is a great tool for enhancing a live performance or for copying a lick or fast-played phrase.

- **SmartMedia card allows unlimited number of patches and samples**

Patches and samples can be stored on separately available SmartMedia cards (up to 60 patches x 5 groups / 60 samples per card). Stored data can be read back into the unit at any time. This gives you unlimited potential for building a library of patches and samples.

- **Integrated rhythm function**

60 built-in rhythm patterns using natural-sounding PCM sources are available, which is great for practice or a quick jam session.

- **Link samples, rhythm, pedal settings to patches**

The selection of rhythm patterns and samples can be stored for each patch individually, allowing synchronized operation when switching patches. Even the pedal adjustment range can be memorized for a patch.

In order to get the most out of this sophisticated product, please read this manual carefully before use.

We recommend that you keep the manual at hand for future reference.

# Controls and Functions

This section identifies the parts of the 707II and describes preparations for use.

## Top Panel

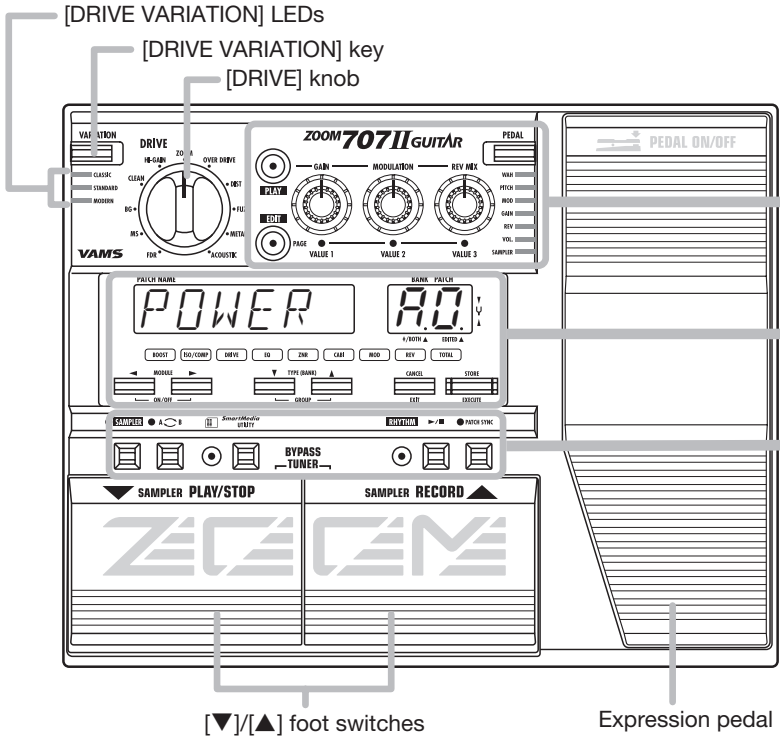

## Rear Panel

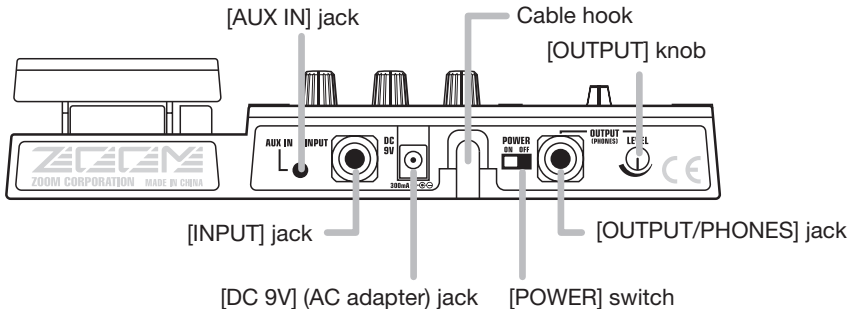

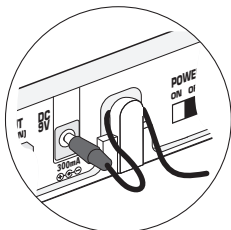
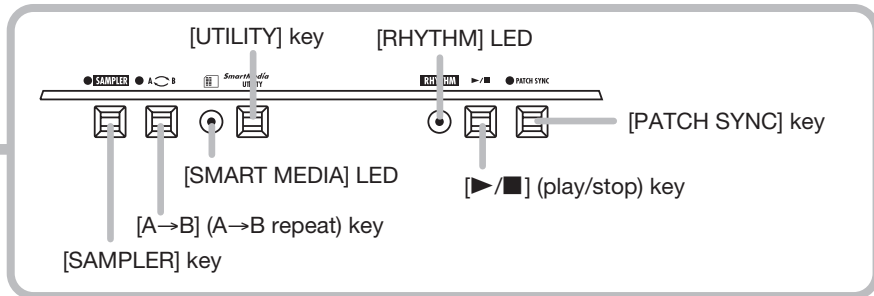
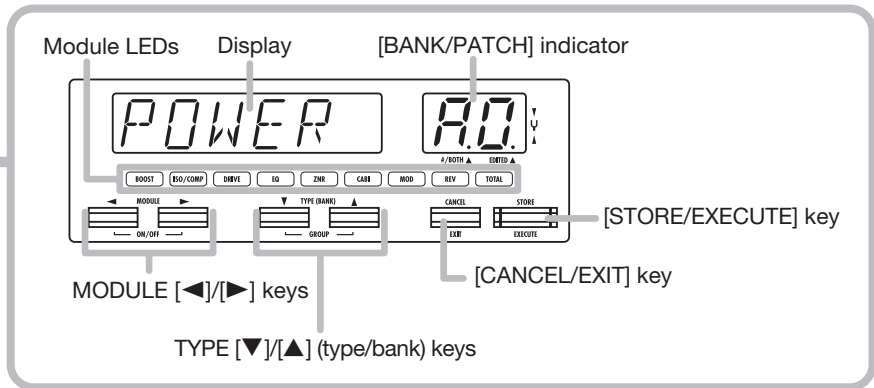
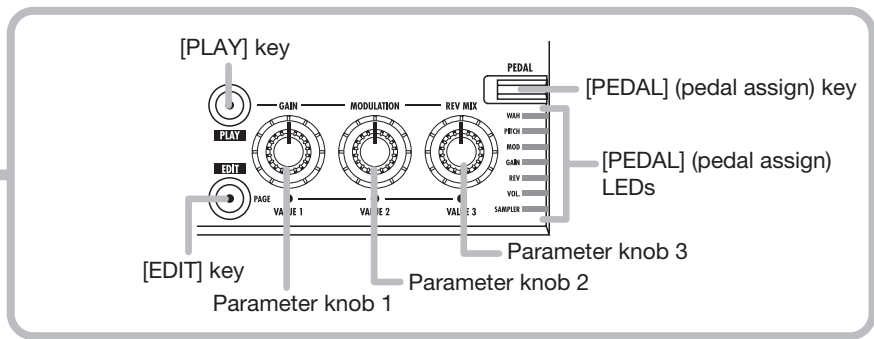

Loop the cable of the AC adapter around the hook as shown in the diagram before connecting it to the [DC 9V] jack. This will prevent the plug from being disconnected if the cable is accidentally pulled.

# Preparations

## Inserting Batteries and a SmartMedia card

When wishing to power the 707II from batteries, insert them as shown below. When wishing to store patch data or sample data on a SmartMedia card, insert the card as shown below.

1. Turn the unit over and open the battery compartment cover.

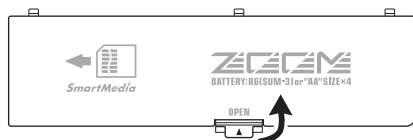

2. Insert four fresh IEC R6 (size AA) batteries into the battery compartment. The use of alkaline batteries is recommended.

The correct battery orientation is indicated inside the battery compartment.

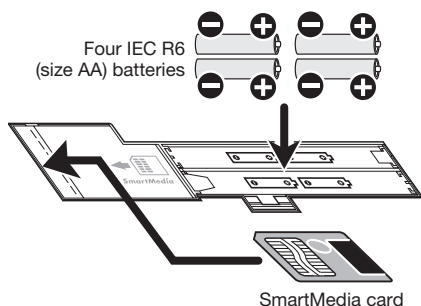

3. To store patch and sample data, insert a SmartMedia card into the card slot, as shown above.

### ◆ Caution ◆

- If the card is inserted upside down or with wrong orientation, it does not go all the way in. Do not try to force the card in, because this will damage the card.
- Never insert or remove the SmartMedia card while power to the unit is turned on. Otherwise all data on the card may be lost.
- Standard SmartMedia cards (designed for 3.3V) with a capacity from 16 – 128 MB can be used.
- When wishing to use a SmartMedia card that has been formatted in other equipment such as a computer or digital camera, you must format the card again in the 707II, as described on page 31.
- To store the contents of a SmartMedia card in a computer, a SmartMedia card reader/writer is required.

4. Close the battery compartment cover.

### ● NOTE ●

- If the indication "BATT" appears on the display, the batteries are exhausted. Replace the batteries as soon as possible.



- When not using the unit for an extended period, remove the batteries to prevent the possibility of damage by leaking battery fluid.

## Getting Connected

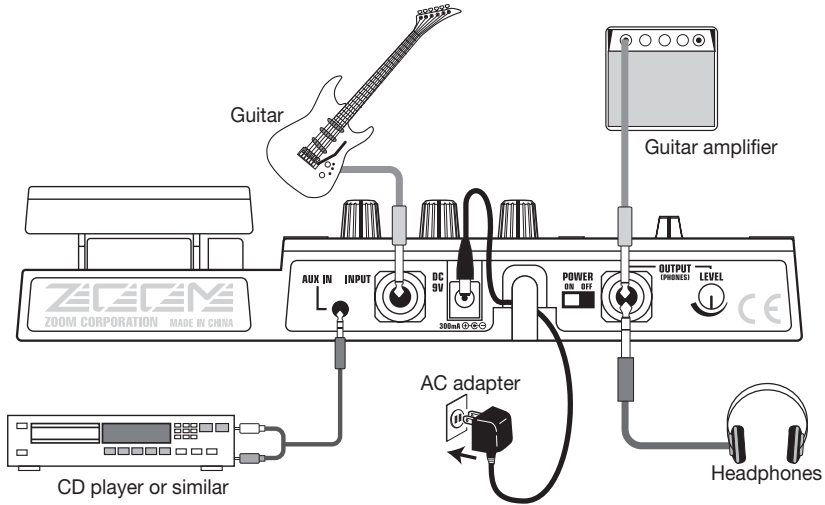

1. Make sure that the amplifier and the 707II are off.

Turn the volume at the amplifier to minimum.

2. To power the unit from the AC adapter, insert the small plug of the adapter cable into the [DC 9V] jack on the 707II. Then plug the adapter into an outlet.
3. Connect the guitar to the [INPUT] jack of the 707II, using a mono cable.
4. Connect the [OUTPUT/PHONES] jack of the 707II to the guitar amplifier, using a mono cable.

You can also use a Y cable to supply the signal in stereo to two amplifiers.

5. To monitor the sound with headphones, plug the phones into the [OUTPUT/PHONES] jack.
6. Turn power on in the following order: 707II → amplifier.

### ● NOTE ●

If you turn the 707II on while the amplifier is already powered up, damage to the speaker may result. Always turn power to the amplifier on last.

7. Raise the volume setting of the instrument and amplifier, and adjust the [OUTPUT] knob on the rear panel of the 707II.

# Quick Guide (Let's Play)

Immediately after being turned on, the 707II is in the so-called "play mode". The Quick Guide explains the basic steps in play mode. This will let you use the unit right away.

## Selecting a patch

- 1 In play mode, press one of the [▼]/[▲] foot switches.

In play mode, the information shown at right appears on the display and the [BANK/PATCH] indicator.

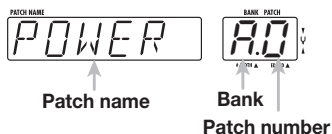

- 2 To directly switch the bank, press one of the TYPE [▼]/[▲] keys.

Each push of a key switches to the next bank.

- ◆ For a detailed explanation of patch switching, see p. 10.
- ◆ To set up the unit so that the patch sound is switched only after confirmation, see p. 23.

## Patches, groups and banks

A combination of 707II effects, each with distinct parameter settings, is called a patch. Patches are organized in banks (A - F, 0 - 5) and patch numbers (0 - 9). It is also possible to assign a name of up to six characters to a patch.

The patches of the 707II are stored in two different groups: the USER group (banks A - F) for read-and-write patches that can be freely overwritten by the user, and the PRESET group (0 - 5) for read-only patches that cannot be changed by the user. There are 60 patches in each group, resulting in a total of 120 patches.

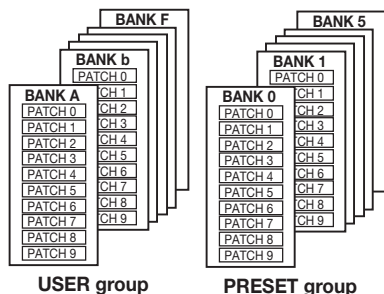

## Altering an effect with the pedal

- 1 To alter an effect in real time, move the expression pedal while playing your instrument.

Move back and forth



The effect depth or volume changes as you move the pedal. Which parameter changes depends on the patch.

- 2 To switch the effect module on or off, push the expression pedal fully down.



The expression pedal also incorporates a push-down switch that allows on/off control of a specific effect module.

- ◆ For details on selecting the effect module to be controlled by the pedal, see p. 23.

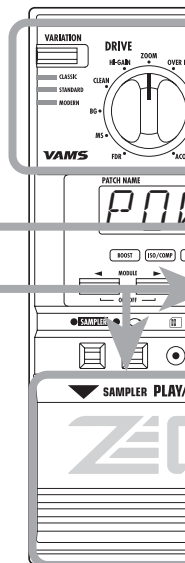



## Changing the sound of a patch

- 1 While playing your instrument, operate the knobs on the panel.

Each knob controls a certain parameter, as indicated below.

### [DRIVE VARIATION] key

#### [DRIVE] knob

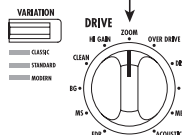

Selects the distortion type for the DRIVE module.

#### Parameter knob 1

Adjusts the distortion level of the DRIVE module.

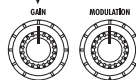

#### Parameter knob 2

Adjusts the modulation rate of chorus, flanger, and similar effects. For some patches, the knob adjusts the echo level.

#### Parameter knob 3

Adjusts the reverb and echo level.

- ◆ For a list of parameters adjusted with the knobs, see p. 33 – 38.
- ◆ To edit a patch more in detail, see p. 18.

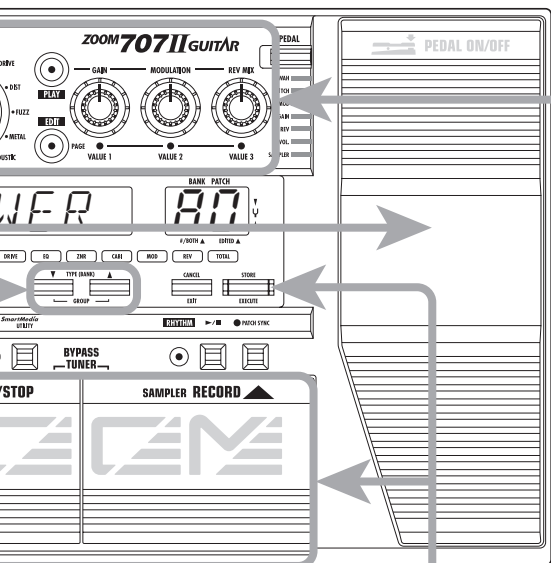

## Storing an effect

- 1 Press the [STORE/EXECUTE] key.

The 707II goes into store standby mode.



If a patch from the PRESET group was selected, "A0" in the USER group is automatically selected as store target.

- 2 Use the [▼]/[▲] foot switches to select the store target bank and patch number.

- 3 To carry out the store operation, press the [STORE/EXECUTE] key once more.

To cancel the process, press the [CANCEL/EXIT] key.

- ◆ For a detailed explanation of patch storing, see p. 20.
- ◆ For information on how to return the USER group patches to the factory default condition, see p. 32.

# Listening to Patches (Play Mode Operation)

The condition where you call up patches stored in the memory of the 707II and use them for playing your instrument is called "play mode". This is the condition the unit is in when you turn the power on. The various operations possible in play mode are described in this section.

## Panel Display in Play Mode

In play mode, the panel shows the following information.

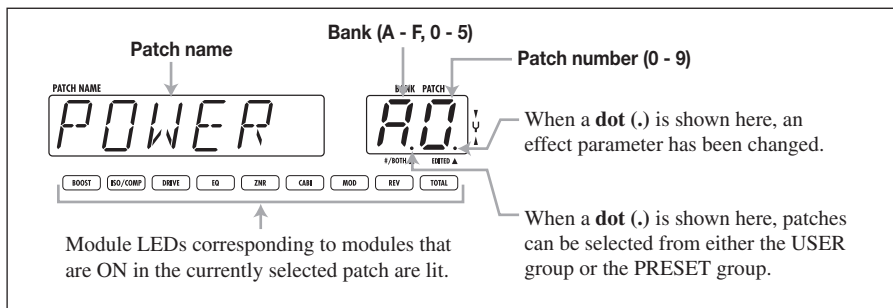

## Selecting a Patch

### 1. In play mode, press one of the [▼]/[▲] foot switches.

Pressing the [▲] foot switch moves to the next higher patch, and pressing the [▼] foot switch moves to the next lower patch.

#### USER group

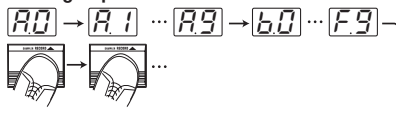

#### PRESET group

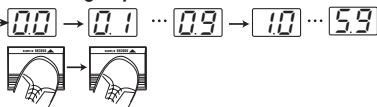

### 2. To directly switch the bank, use the TYPE [▼]/[▲] keys.

Pressing the TYPE [▲] key moves to the next higher bank, and pressing the TYPE [▼] key moves to the next lower bank.

### NOTE

While playing a rhythm pattern, direct bank selection is not available.

### 3. It is also possible to set up the unit so that only patches from the USER group or from the PRESET group are switched. To do this, press both TYPE [▼]/[▲] keys together.

With each push, the group from which patches can be selected is toggled as follows.

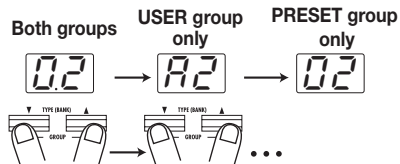

### HINT

To set up the unit so that the patch sound is switched only after confirmation, see p. 23.

## Using the Tuner Function

The 707II incorporates an auto-chromatic tuner for guitar. To use the tuner function, the built-in effects must be bypassed (temporarily turned off) or muted (direct sound and effect sound turned off).

### 1. To set the 707II to the bypass (mute) condition, press and release both [▼]/[▲] foot switches in play mode.

When you press and immediately release both foot switches, the 707II goes into bypass mode.



While the 707II is in the bypass condition, all effects are off and only the direct sound is output. The expression pedal works as a volume pedal.

When you press and hold both foot switches for at least 1 second and then release them, the 707II goes into mute mode.

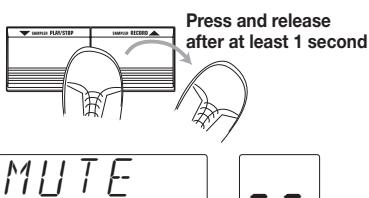

While the 707II is in the mute condition, there is no sound output from the [OUTPUT/PHONES] jack.

### 2. Play the open string you want to tune.

The [BANK/PATCH] indicator shows the note which is closest to the current pitch. Tune your instrument until the note indication shows the desired note.

The note is shown on the left part of the indicator

A = $\overset{\frown}{A}$	D = $\overset{\frown}{d}$	G = $\overset{\frown}{G}$
A# = $\overset{\frown}{A\#}$	D# = $\overset{\frown}{d\#}$	G# = $\overset{\frown}{G\#}$
B = $\overset{\frown}{b}$	E = $\overset{\frown}{E}$	
C = $\overset{\frown}{C}$	F = $\overset{\frown}{F}$	
C# = $\overset{\frown}{C\#}$	F# = $\overset{\frown}{F\#}$	

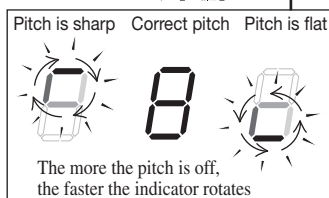

To the right of the note, a symbol indicates by how much the tuning is off.

### 3. To change the reference pitch of the tuner, use the TYPE [▼]/[▲] keys.

The current reference pitch is briefly shown on the display. The default setting after power-on is center A = 440 Hz.



Reference pitch value

### 4. While the reference pitch is shown, you can change the pitch by pressing the TYPE [▼]/[▲] keys.

The available setting range is 435 – 445 Hz in 1-Hz steps. When the 707II is turned off and on again, it will be reset to 440 Hz.

### 5. Press one of the [▼]/[▲] foot switches.

The 707II returns to the play mode.

## Using the Easy Edit Function

The 707II incorporates a function called "Easy Edit" that allows adjusting some effect parameters during play. This is done with the parameter knobs 1 – 3, the [DRIVE VARIATION] key, and the [DRIVE] knob on the front panel.

### 1. To change the sound of a patch in play mode, operate parameter knobs 1 – 3.

The parameters controlled by the knobs are as follows.

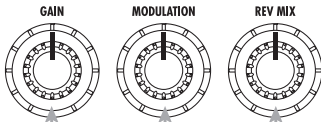

#### Parameter knob 1

Adjusts the DRIVE module distortion amount.

#### Parameter knob 2

Adjusts a major parameter of the MOD module (such as chorus depth).

#### Parameter knob 3

Adjusts a major parameter of the REV module (such as echo or reverb amount).

The actual parameter controlled by parameter knobs 1 – 3 depends on the effect selected for the current effect module.

When a knob is turned, the current setting of the relevant parameter is shown on the BANK/PATCH indicator, and a dot (.) appears at the "EDITED" position. This indicates that the parameter has been changed. If the parameter is returned to the original setting, the dot disappears.



When a dot (.) is shown here, the effect parameter has been changed.

### 2. Use the [DRIVE] knob and [DRIVE VARIATION] key to select the effect to be used for the DRIVE module.

The effects of the DRIVE module can be directly selected with the [DRIVE] knob and [DRIVE VARIATION] key.

The [DRIVE] knob selects the general effect type (amp type or compact effect type), and the [DRIVE VARIATION] key selects one of several variations for that effect. Each push of the [DRIVE VARIATION] key cycles through the CLASSIC → STANDARD → MODERN settings, and the corresponding LED lights up.

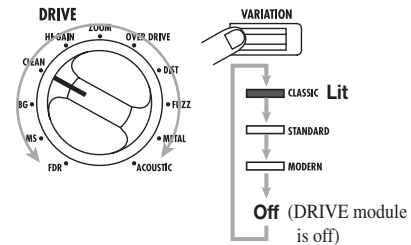

#### HINT

- For an explanation of DRIVE module effects, see p. 33.
- In play mode, you can also use the MODULE [◀]/[▶] keys to edit the PATLVL parameter (volume level for each patch).

### 3. To store an edited patch, carry out the steps for storing (→ p. 20).

Note that if another patch is called up without storing the edited patch, the edited contents will be lost.

#### NOTE

While playing a rhythm pattern, the parameter knobs 1 – 3 adjust rhythm parameters.

## Using the Sampler Function

The 707II incorporates a sampler function that allows recording the input signal in the internal memory or on a SmartMedia card.

This can be used to record a phrase from the guitar connected to the [INPUT] jack or the sound from an external source such as a CD player connected to the [AUX IN] jack. When using the internal memory, the maximum recording duration is 6 seconds (1 sample). When using a 16 MB SmartMedia card, up to 4 minutes (maximum 60 samples) can be recorded. A recorded phrase can also be played at slower speed without changing the pitch. This is convenient to copy a fast-played phrase from a CD.

For playing a sample, you can choose between two modes: "one-shot playback" where the sampled phrase is played once when you operate a key or pedal, and "loop playback", where the sampled phrase continues to play until stopped.

- 1. When wishing to use a SmartMedia card, turn power to the 707II off, insert the SmartMedia card into the card slot, and then turn power on again. (For information on inserting a SmartMedia card, see p. 6.)**

### NOTE

- Before using a SmartMedia card in the 707II, it must be formatted (→ p.31).
- Never insert or remove the SmartMedia card while power to the unit is turned on. Otherwise all data on the card may be lost.

- 2. Connect the input source to the [INPUT] jack or [AUX IN] jack.**

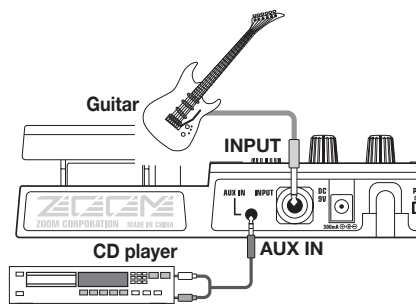

- 3. Turn power to the 707II on and press the [SAMPLER] key in play mode.**

For patches in which the expression pedal is assigned to SAMPLER, the sampler function

can also be turned on by pushing the pedal all the way down (→ p.24).

The subsequent steps are slightly different, depending on whether a SmartMedia card is inserted or not.

### SmartMedia card not inserted

The following indication appears on the display, and the unit goes into the sampler standby mode. Proceed to step 4.

SAMPLE

### SmartMedia card inserted

The following indication appears on the display, and the unit goes into the sampler standby mode. The sample number is shown on the [BANK/PATCH] indicator.

SP NO 1

When using a SmartMedia card, the samples on the card are assigned numbers from 1 – 60. If necessary, use parameter knob 1 to select a number. Then proceed to step 4.



### NOTE

- If the indication "NO" is followed by a "\*", a sample is recorded in that number.
- If you select a number in which a sample has already been recorded, the previous sample will be overwritten. Be careful not to overwrite a sample that you wish to keep.

### HINT

- For information on how to assign a sample to a patch when storing, see p. 27.
- For information on how to delete unwanted samples from a SmartMedia card, see p. 31

## 4. Use the TYPE [▼]/[▲] keys to select "GT" or "AUX" as input source.

When you press one of the TYPE [▼]/[▲] keys, the currently selected input source is shown on the display. Select one of the following two sources.

- **GT** Signal from [INPUT] jack
- **AUX** Signal from [AUX1 IN] jack

### HINT

- If "GT" is selected, the signal after passing the effects is sampled. If "AUX" is selected, the effects are bypassed.
- When recording from the [AUX IN] jack, you can minimize noise and distortion by turning the [OUTPUT] knob up past the midway point and adjusting the output level of the external source so that the volume is about equal to that of a guitar.
- After recording, you can use the SP LVL parameter to control the playback level of the sample.

## 5. Press the [▲] foot switch and play the phrase you want to record (or start playback at the external source component).

During sampling, the indication "REC" is shown on the display. The module LEDs on the panel show the elapsed sampling time.



### NOTE

- When sampling to internal memory, sampling ends when all module LEDs are lit.
- When sampling to SmartMedia card, the module LEDs go through the cycle repeatedly.

## 6. To stop sampling, press the [▼] foot switch.

If you do not press any key after starting to sample, sampling automatically ends when the maximum sampling time is up (6 seconds with internal memory, 4 minutes with a 16 MB SmartMedia card).

## 7. Use parameter knob 2 to select the sample playback mode.

When you operate parameter knob 2, the indication "SPMODE" appears on the display. The [BANK/PATCH] indicator shows the playback mode. The following settings are available.



- **n1** Normal speed playback
- **n2** Half tempo, half pitch playback
- **P2** Half tempo, normal pitch playback
- **n4** Quarter tempo, quarter pitch playback
- **P4** Quarter tempo, normal pitch playback

## 8. Use the foot switches and panel keys to control sample playback (start/stop/rewind/fast-forward).

While the sampler function is on, you can use the foot switches and panel keys for one-shot playback.

MODULE [◀] Key      MODULE [▶] Key  
 Rewind                      Fast-forward

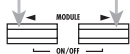

Press both keys to return to the start of the sample

[▼] foot switch      [▲] foot switch  
 Play/Stop              Start sampling

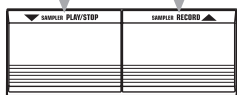

**9. If necessary, you can adjust the sample playback level with parameter knob 3.**

When you operate parameter knob 3, the indication "SP LVL" appears on the display. The [BANK/PATCH] indicator shows the input signal level, using a range from 0 – 30. Adjust the level to obtain a suitable playback volume.

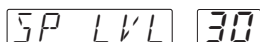

**HINT**

You can also adjust the playback level with the expression pedal.

**10. To carry out loop playback of a specific interval, play the sample and press the [A→B] key at the desired start point.**

The [A→B] LED flashes and loop playback is enabled. The point at which you pressed the [A→B] key is taken as the loop start point. If no end point has been set, the end of the sample is taken as the end point.

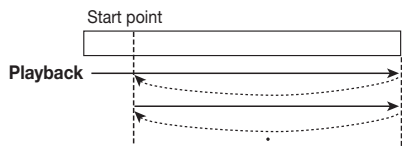

**11. If you wish to set the loop end point, press the [A→B] key once more during loop playback of the sample.**

The [A→B] LED now stays constantly lit, and the point at which you pressed the [A→B] key is taken as the loop end point.

When the end point has been set, loop playback is carried out between the start and end points.

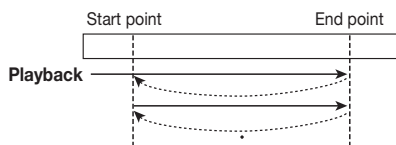

**12. To cancel loop playback, press the [A→B] key once more (or change the sample number).**

The [A→B] LED goes out, and the unit returns to normal one-shot playback.

**13. To terminate the sampler function, press the [SAMPLER] key while the sampler is stopped, or push the expression pedal all the way down.**

The unit returns to normal play mode.

**NOTE**

- The start point and end point settings are reset when you change the sample number or switch the sampler function off or on.
- The sampler function cannot be used together with the rhythm pattern function.
- While the sampler function is on, the MOD module and REV module cannot be used. (They are automatically set to OFF.)
- When sampling to a SmartMedia card, the sampled data are stored on the SmartMedia card automatically. There is no need for the user to perform any steps for storing.

## Using the Rhythm Function

The 707II incorporates 60 rhythm patterns which can be selected for playback. This is convenient for parts practice or a quick jam session.

### 1. Press the [▶/■] key in play mode.

Rhythm pattern playback starts. The display shows the currently selected pattern, and the [BANK/PATCH] indicator briefly shows the pattern number. The [RHYTHM] LED flashes in sync with the rhythm pattern tempo.



### 2. Use parameter knobs 1 – 3 to control rhythm pattern play.

In play mode, parameter knobs 1 – 3 have the following functions.

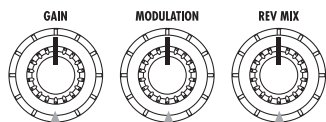

**Parameter knob 1**  
Changes the rhythm pattern type.

**Parameter knob 2**  
Changes the rhythm pattern tempo.

**Parameter knob 3**  
Changes the rhythm pattern volume.

When you operate a parameter knob during rhythm pattern play, the indication on the display and [BANK/PATCH] indicator changes temporarily.



**Parameter knob 1**



**Parameter knob 2**



**Parameter knob 3**

### **HINT**

- You can also switch patches during rhythm pattern playback.
- You can also play a rhythm pattern in the bypass/mute condition and in the edit mode, but the parameter knobs cannot be used to control the rhythm pattern in this case.
- The rhythm pattern type, tempo, and volume settings revert to the default condition when the unit is turned off and on again.
- You can also use the TYPE [▼]/[▲] keys to change the pattern type.

### 3. To stop rhythm pattern playback, press the [▶/■] key once more.

It is also possible to store a rhythm pattern for specific patches. When you have assigned rhythm patterns to patches and you set the [PATCH SYNC] key to On, rhythm patterns will be switched together with the patches (→ p. 26).



## Rhythm pattern list

Rhythm pattern	Display indication	[BANK/PATCH] indicator		Rhythm pattern	Display indication	[BANK/PATCH] indicator		
8BEAT1	<i>8BEAT</i>	1	Basic patterns	METRO (triple time)	<i>METRO</i>	3	Metronome patterns	
8BEAT2	<i>8BEAT</i>	2		METRO (quadruple time)	<i>METRO</i>	4		
8BEAT3	<i>8BEAT</i>	3		METRO (quintuple time)	<i>METRO</i>	5		
8BEATSHUFFLE	<i>8SHUFL</i>				METRO			
16BEAT1	<i>16BEAT</i>	1			INTRO1	<i>INTRO</i>	1	Intro patterns
16BEAT2	<i>16BEAT</i>	2			INTRO2	<i>INTRO</i>	2	
16BEAT3	<i>16BEAT</i>	3			INTRO3	<i>INTRO</i>	3	
16BEATSHUFFLE	<i>16SHFL</i>				INTRO4	<i>INTRO</i>	4	
3/4	3/4				INTRO5	<i>INTRO</i>	5	
6/8ROCK	<i>6/8</i>				INTRO6	<i>INTRO</i>	6	
5/4	5/4	1			INTRO7	<i>INTRO</i>	7	
5/4ROCK	<i>5/4</i>	2			INTRO8	<i>INTRO</i>	8	
ROCK'nROLL1	<i>R'nR</i>	1		Rock patterns	INTRO9	<i>INTRO</i>	9	Ending patterns
ROCK'nROLL2	<i>R'nR</i>	2			ENDING1	<i>ENDING</i>	1	
ROCK1	<i>ROCK</i>	1	ENDING2		<i>ENDING</i>	2		
ROCK2	<i>ROCK</i>	2	ENDING3		<i>ENDING</i>	3		
HARDROCK1	<i>HARD</i>	1	ENDING4		<i>ENDING</i>	4		
HARDROCK2	<i>HARD</i>	2	ENDING5		<i>ENDING</i>	5		
METAL1	<i>METAL</i>	1			ENDING6	<i>ENDING</i>	6	
METAL2	<i>METAL</i>	2						
THRASH	<i>THRASH</i>							
PUNK	<i>PUNK</i>							
POP1	<i>POP</i>	1	Dance patterns					
POP2	<i>POP</i>	2						
DANCE1	<i>DANCE</i>	1						
DANCE2	<i>DANCE</i>	2						
DANCE3	<i>DANCE</i>	3						
FUNK1	<i>FUNK</i>	1						
FUNK2	<i>FUNK</i>	2						
BALLAD1	<i>BALLAD</i>	1						
BALLAD2	<i>BALLAD</i>	2						
BLUES1	<i>BLUES</i>	1						
BLUES2	<i>BLUES</i>	2						
COUNTRY	<i>COUNTRY</i>		Other genres					
BOSSANOVA	<i>BOSSA</i>							
JAZZ1	<i>JAZZ</i>	1						
JAZZ2	<i>JAZZ</i>	2						
REGGAE	<i>REGGAE</i>							
SKA	<i>SKA</i>							
LATIN1	<i>LATIN</i>	1						
LATIN2	<i>LATIN</i>	2						

# Changing the Sound of a Patch (Edit Mode)

The edit mode allows you to freely alter the parameters that make up a patch, so that you can create your own patches. This section describes how to edit patches and how to store edited patches.

## Patch Configuration

Each patch of the 707II consists of several effects (effect modules), as shown in the illustration below. A patch is a combination of modules, each with their distinct parameter settings.



Within each module, there are several different but related effects which are called effect types. For example, the MODULATION module comprises effect types such as CHORUS, PHASER, and WAH.

The elements that determine the sound of a patch are called effect parameters. Each module has several effect parameters, whose value can be adjusted with the parameter knobs 1 – 3, the [DRIVE] knob, [DRIVE VARIATION] key, etc.

### NOTE

Also within the same module, different effect types will have different parameters.

## Basic Edit Mode Steps

This section describes the basic procedure for editing patches. For information on effect types and parameters in the various modules, see p. 33 – 38.

### 1. In play mode, select the patch you want to edit.

Patches for editing can be selected from either the USER group or the PRESET group. However, the PRESET group does not allow storing. When you have altered a patch from the PRESET group and want to store it, "A0" in the USER group is automatically selected as store target.

### 2. Press the [EDIT] key.

The 707II switches to the edit mode. The LED of the module currently selected for editing

flashes. (The first time you switch to edit mode after the unit was turned on, the TOTAL module will be selected.)

### 3. Use the MODULE [◀]/[▶] keys to select the module you want to edit.

Modules are switched in the order shown below, and the respective module LED is flashing.

The display shows the effect type currently selected for that module. If the effect can be controlled with the expression pedal, the indication "Pd" is shown on the [BANK/PATCH] indicator.

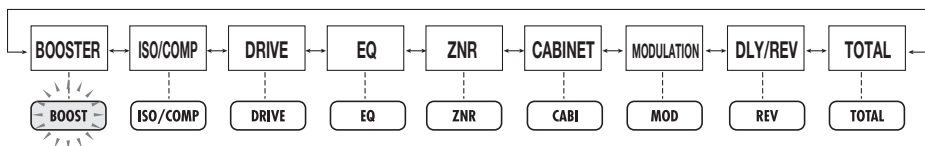

HALL

Effect type

Pd

Shown if selected effect can be controlled by pedal

**NOTE**

Because the ISOLATOR, EQ, and TOTAL modules have many parameters, settings are divided into several pages. To switch the page, press the [EDIT] key while the corresponding module LED is lit.

**4. To switch the on/off status of the selected module, press both MODULE [◀]/[▶] keys together.**

When you change the module on/off status, effect type selection, or a parameter value, a dot (.) appears at the "EDITED" position of the [BANK/PATCH] indicator. When this dot is shown in edit mode, it means that the currently selected module has been edited. If you return the module to the original setting, the dot disappears.



When a dot (.) is shown here, the currently selected module was edited.

**5. To change the effect type of the currently selected module, press one of the TYPE [▼]/[▲] keys.**

**6. To change a parameter setting, use the parameter knobs 1 – 3.**

Parameter knobs 1 – 3 serve for adjusting three parameters of the currently selected module. When you operate a knob, the display shows the parameter name, and the [BANK/PATCH] indicator shows the current setting value.

For example, if the effect type ROOM is selected for the REV module, parameter knobs 1 – 3 control the following parameters.

- **Parameter knob 1:** TIME
- **Parameter knob 2:** TONE
- **Parameter knob 3:** MIX

**7. If you want to check the current setting without moving the parameter knob, press the TYPE [▼]/[▲] keys together. With each push of the two keys, the names of parameters 1 – 3 and the respective settings are shown.**



First push



Second push



Third push

**8. To directly switch the effect type of the DRIVE module, use the [DRIVE] knob and [DRIVE VARIATION] key.**

As in play mode, the [DRIVE] knob and [DRIVE VARIATION] key directly control the effect type of the DRIVE module.

**9. Repeat steps 3 – 8 to edit other modules.**

**10. When editing is completed, press the [PLAY] key or the [CANCEL/EXIT] key.**

The 707II returns to the play mode. A dot (.) appears at the "EDITED" position of the [BANK/PATCH] indicator if any aspect of the patch has been edited.

**NOTE**

If you wish to keep the patch, be sure to perform the store operation. Otherwise all changes will be permanently lost as soon as you switch to another patch. (→ P. 20)

## Storing and Swapping Patches

This section describes how to store an edited patch in memory, and how to swap patches in the USER group.

### 1. In play mode or edit mode, press the [STORE/EXECUTE] key.

The 707II enters the store standby condition. The patch name and the indications "SAVE" and "SWAP" are shown alternately on the display. The [BANK/PATCH] indicator shows the bank and patch number.

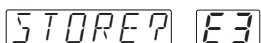

#### **HINT**

To change the name of an edited patch, see p. 38.

### 2. Use the MODULE [◀]/[▶] keys to select either "SAVE" or "SWAP".

#### **NOTE**

If the original patch is from the PRESET group, "SWAP" cannot be selected.

### 3. Use the TYPE [▼]/[▲] keys or the [▼]/[▲] foot switches to select the target patch for storing.

The name of the newly selected patch and the indication "STORE?" are shown alternately on the display. The bank and patch number flash on the [BANK/PATCH] indicator.

#### **NOTE**

The PRESET group cannot be selected as store target. If you press the [STORE/EXECUTE] key while a patch from the PRESET group is selected, the selection automatically changes to "A0" in the USER group.

### 4. To carry out the store or swap operation, press the [STORE/EXECUTE] key once more.

The store or swap operation is performed, and then the unit returns to the original mode. If the patch in step 1 was being edited, the editing changes are stored.

If you press the [CANCEL/EXIT] key instead of the [STORE/EXECUTE] key, the store/swap operation is canceled and the unit returns to the original mode.

# Other Functions

The 707II also incorporates various other convenient functions which are described in this section.

## Using the Hold Delay Function

The DLY/REV module comprises a hold delay effect that allows recording and playing a guitar phrase of up to 2 seconds. You can also play the phrase in reverse or perform loop playback to create interesting "sound-on-sound" layers.

**1. In play mode, select the patch to use with hold delay.**

**2. Press the [EDIT] key to activate edit mode, and select "HLDDLY" as effect type for the DLY/REV module.**

**3. Use parameter knob 1 to set the TIME parameter.**

The TIME parameter determines the length of the recording interval for hold delay. Turning the knob changes the value as follows.

- **1 – 99:** 10 – 990 milliseconds (10-ms units)
- **1.0 – 2.0:** 1.0 – 2.0 seconds (100-ms units)
- **Mn (Manual):** Recording starts when you press the [▲] foot switch and ends when you press the [▲] foot switch again (max. 2 seconds).

**4. Use parameter knob 2 to set the MODE parameter.**

The MODE parameter determines how the recorded phrase is played back. The following three modes are available.

- **nL (Normal):** Normal direction playback
- **So (Sound-on-sound):** Recorded contents are played back repeatedly to create an overlay.  
If you press the [▲] foot switch, the phrase played until the switch is pressed again is added to the sound.
- **rS (Reverse):** Reverse direction playback.

**5. Use parameter knob 3 to set the MIX parameter.**

The MIX parameter controls the mixing ratio of the delayed sound. A setting of 30 results in equal levels of direct sound and delayed sound.

**6. Press the [PEDAL] key a few times until the [PEDAL] LED of the REV module flashes.**

The expression pedal can now be used to switch the hold delay function on and off.

**7. Store the patch and return to play mode.**

When a patch in which hold delay can be used is selected in play mode, the DLY/REV module LED and the [PEDAL] LED are flashing.

**8. Push the expression pedal all the way down.**

The hold delay function is switched on and the unit is in recording standby mode. The indication "STOP" is shown on the display.



**9. While playing your guitar, press the [▲] foot switch to start recording.**

The indication "REC" is shown on the display. The actual operation depends on the TIME parameter set in step 3.

■ **If a numeric value is set as TIME parameter**

Recording starts at the moment you push the [▲] foot switch and continues for the duration set with the TIME parameter. After recording ends, loop playback starts automatically.

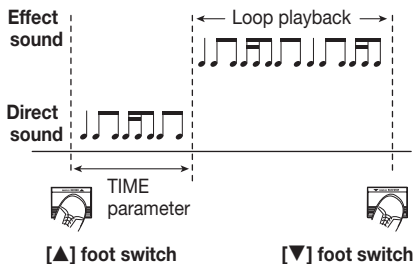

■ **If TIME parameter is set to "Mn"**

Recording starts at the moment you push the [▲] foot switch and continues until you push the switch again, or until 2 seconds have elapsed. After recording ends, loop playback starts automatically.

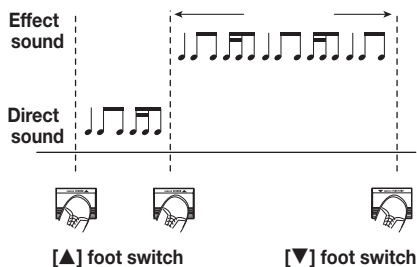

■ **If TIME parameter is set to "Mn" and MODE parameter to "So"**

When the TIME parameter is set to "Mn" and the MODE parameter to "So" (sound-on-sound), pressing the [▲] foot switch adds the currently played phrase until the switch is pressed again.

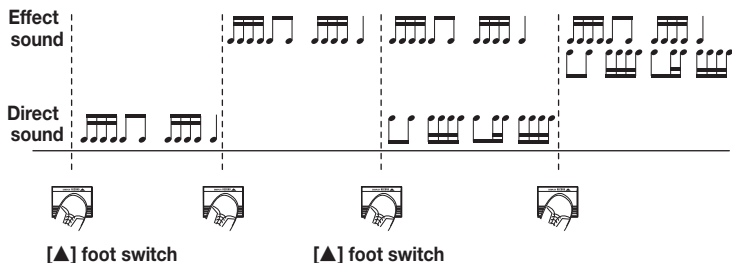

**10. To stop playback, press the [▼] foot switch.**

**11. To turn the hold delay function off, push the expression pedal once more all the way down.**

The unit returns to the play mode.

## Changing the Patch Call Method

In the factory default condition, patches are switched as soon as you make the selection, resulting in an immediate change in the sound. If you want to change to a distant patch, all the intermediate patches will briefly change the sound, which may not be desirable, especially during a performance. In such a case, you can change to the preselect method.

When the preselect method is enabled, you first select the desired patch, but the sound does not change until confirmed by you.

1. To change the patch call method to preselect, hold down the [▲] foot switch while turning power to the 707II on.

2. Select the patch in play mode.

When you select a patch in this condition, the display and [BANK/PATCH] indicator show the new patch (flashing), but the sound does not change.



3. To confirm the patch change, press both [▼]/[▲] foot switches together.

The display and [BANK/PATCH] indicator stop flashing, and the unit switches to the new patch, causing the sound to change.

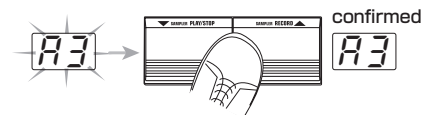

To return to the default patch selection method, turn the 707II off and on again.

## Using the Pedal to Control an Effect

You can use the expression pedal of the 707II to control the parameter, on/off status, or volume level of a specific effect. The pedal adjustment range can be memorized individually for a patch.

1. Select a patch in play mode.
2. Use the [PEDAL] key to select the module/effect type to be controlled with the expression pedal.

Each push of the [PEDAL] key cycles through the [PEDAL] LEDs as shown below.

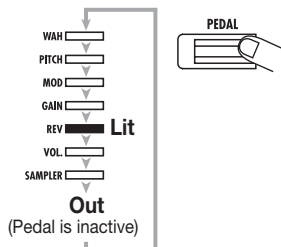

The [PEDAL] LEDs indicate the module/effect type assigned to the pedal. The meaning of the LEDs is explained below.

### • WAH

The expression pedal functions as a pedal wah. The effect type P-WAH (pedal wah) of the MODULATION module is assigned to the pedal, and the FREQ parameter can be adjusted. Even if another effect type is currently selected for the MODULATION module, the effect type is temporarily switched to P-WAH.

### • PITCH

The expression pedal functions as a pitch shifter. The effect type P-PIT (pedal pitch) of the MODULATION module is assigned to the pedal, and pitch can be adjusted. Even if another effect type is currently selected for the

MODULATION module, the effect type is temporarily switched to P-PIT.

- **MOD**

The effect type currently selected for the MODULATION module is adjusted by the pedal. Which parameter is controlled depends on the effect type.

- **GAIN**

The distortion gain is adjusted by the pedal. The GAIN parameter of the DRIVE module (for some effect types the RESONANCE/TOP parameter) is assigned to the pedal.

- **REV**

The effect type currently selected for the DLY/REV module is adjusted by the pedal. Which parameter is controlled depends on the effect type.

- **VOL**

The master volume is adjusted by the pedal.

- **SAMPLER**

The sampler function is switched on/off by the pedal. Pushing the pedal all the way down toggles between sampler on ([PEDAL] LED lit) and sampler off ([PEDAL] LED flashed).

Also if a module is currently off, selecting it with the [PEDAL] key will cause its [PEDAL] LED to light and the module will temporarily come on. If a patch is stored in this condition, the module will be stored as ON.

The actual parameter that is controlled by the pedal depends on the effect type. For details, see p. 33 – 38.

 **HINT** 

The above procedure for assigning a module/effect type to the expression pedal can be carried out also in edit mode.

**3. Press the [EDIT] key to activate the edit mode.**

**4. Use the MODULE [◀]/[▶] keys to select the TOTAL module.**

**5. Press the [EDIT] key once more.**

The key lights up in green. In this condition, parameter knobs 2 and 3 have the following functions.

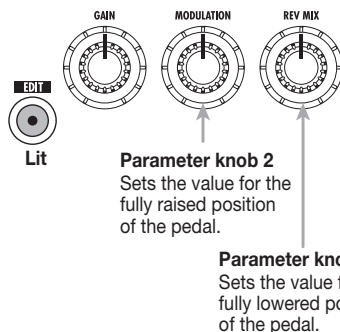

**6. Use parameter knob 2 and 3 to set the PDLMIN value (when pedal is fully raised) and PDLMAX value (when pedal is fully lowered). The setting range for both values is 0 – 10.**

When you operate parameter knob 2, the indication "PDLMIN" appears on the display. When you operate parameter knob 3, the indication "PDLMAX" appears on the display. The 0 – 10 value is shown on the [BANK/PATCH] indicator.

Setting PDLMIN or PDLMAX to 0 means that the parameter assigned to the pedal will be at the minimum value. Setting PDLMIN or PDLMAX to 10 means that the parameter assigned to the pedal will be at the maximum value.

When the 707II is in the default condition, PDLMIN is set to 0 and PDLMAX is set to 10. As the pedal is depressed, the parameter value gradually increases from minimum to maximum.

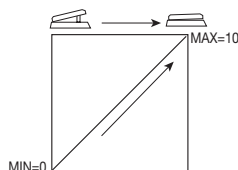



For example, when PDLMIN is set to 4 and PDLMAX to 8, the parameter adjustment range will be limited as shown in the illustration below.

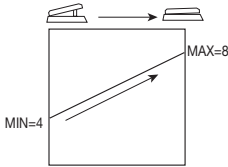

When PDLMIN is set to 7 and PDLMAX to 2, pushing the pedal decreases the parameter value, and the range is as shown below.

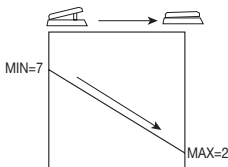

**7. Press the [STORE/EXECUTE] key to store the patch.**

The module which is assigned to the pedal will automatically be stored as ON.

**8. In play mode, move the pedal while playing your guitar.**

The parameter assigned to the pedal changes.

**9. Push the pedal fully down.**

The module which is assigned to the pedal is switched between on and off. If the pedal is assigned to the sampler, the sampler function is switched on or off.

**NOTE**

If the pedal is assigned to the volume, pushing the pedal fully down does not perform any switching action.

**Adjusting the Expression Pedal**

The expression pedal is adjusted for optimum operation at the factory, but sometimes, readjustment may be necessary. If pushing the pedal fully down does not have a strong effect, or if the volume or sound changes excessively even when the pedal is only lightly pushed, adjust the pedal as follows.

**1. Turn power to the 707II on while keeping the [PEDAL] key depressed.**

The indication "MIN" appears on the display.

**2. With the expression pedal fully raised, press the [STORE/EXECUTE] key.**

The display indication changes to "MAX".

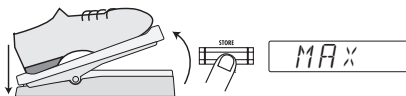

**3. Push the expression pedal fully down and then lift your foot off the pedal.**

The pedal goes back a little.

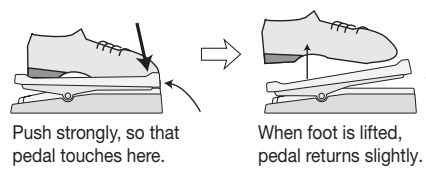

**4. Press the [STORE/EXECUTE] key.**

The adjustment is completed, and the unit returns to the play mode.

**HINT**

- The position of the pedal in step 3 determines the on/off switching point. If you want the pedal to perform on/off switching with a lighter touch, set the pedal to a somewhat higher position.
- If the indication "ERROR" appears, return to step 2 and repeat the procedure.

## Storing Rhythm Patterns and Samples as Part of a Patch

The patches of the 707II can contain not only information about effect type and parameter settings but also about rhythm patterns and samples stored on a SmartMedia card. Using this capability, you can quickly switch rhythm patterns on the fly, or you can have the same sample play every time you call up a certain patch.

### Assigning a rhythm pattern to a patch

By assigning rhythm patterns to patches, you can have the rhythm change in sync with the patches.

1. In play mode, select the patch to which you want to assign a rhythm pattern, and press the [EDIT] key.
2. Use the MODULE [◀]/[▶] keys to select the TOTAL module.
3. Press the [EDIT] key once more.

The [EDIT] key lights up in green. You can now use parameter knob 1 to select the rhythm pattern to assign to the patch.

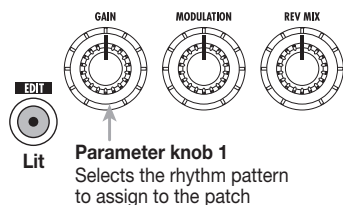

4. Use parameter knob 1 to select the desired rhythm pattern.

The pattern name appears on the display. You can play the pattern by pressing the [▶/■] key.

### **HINT**

Depending on the rhythm pattern type selected here (intro, ending, other), the pattern playback operation when switching patches will differ.

5. Press the [STORE/EXECUTE] key to store the patch.

Assign other rhythm patterns to other patches in the same way.

6. When all patches have been prepared, press the [PATCH SYNC] key so that the LED of the key is lit.

When the [PATCH SYNC] key is set to ON, patches and rhythm patterns are switched in sync.

### **NOTE**

When the [PATCH SYNC] key is set to OFF, the rhythm pattern assignment to the patches has no effect.

7. Call up the patch to which the desired rhythm pattern was assigned.

When the [PATCH SYNC] key is set to ON, the operation when switching patches depends on the type of rhythm pattern that has been assigned.

#### • Intro rhythm pattern (INTRO 1 – 9)

When a patch is switched, rhythm pattern play starts automatically. The pattern continues to play until the [▶/■] key is pressed or until you switch to another patch.

#### • Ending rhythm pattern (ENDING 1 – 6)

After switching a patch, rhythm pattern play begins if you press the [▶/■] key. The pattern automatically stops at the end of the pattern.

#### • Other rhythm pattern

After switching a patch, rhythm pattern play begins if you press the [▶/■] key. The pattern continues to play until the [▶/■] key is pressed again or until you switch to another patch.

## 8. Press the [▶/■] key.

The rhythm pattern of the patch selected in step 7 starts to play. (If an intro type pattern has been assigned, playback starts when the patch is switched in step 7.)

## 9. If necessary, use parameter knobs 2 and 3 to adjust the tempo and volume of the pattern.

Also when the [PATCH SYNC] key is ON, parameter knobs 2 and 3 can be used to adjust the tempo and volume for all patterns. (If desired, you can also use parameter knob 1 to switch to manual operation of the pattern.)

## 10. Switch the patch.

When you switch the patch while a rhythm pattern is playing, the pattern continues to play until the end of the current measure and then switches to the pattern that is assigned to the new patch.

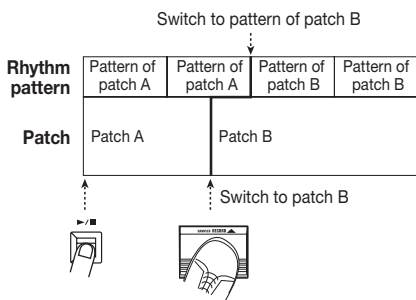

Switch to other patches in the same way.

## 11. To stop rhythm pattern playback, press the [▶/■] key.

If an ending pattern is assigned to a patch, the pattern will play when switching to the patch, and then stop.

## 12. Press the [PATCH SYNC] key so that the LED of the key is out.

## Assigning a sample to a patch

By assigning a sample stored on SmartMedia card to a patch, you can have the sample play every time you select the patch.

1. Insert the SmartMedia card into the 707II and sample the phrase or source material that you want to use.
2. In play mode, select the patch to which you want to assign a sample, and press the [EDIT] key.
3. Use the MODULE [◀]/[▶] keys to select the TOTAL module.

The "PATLVL" (patch level) parameter appears on the display.

## 4. Press the [EDIT] key twice.

The [EDIT] key lights up in orange. You can now use parameter knobs 1 – 3 to control the following functions.

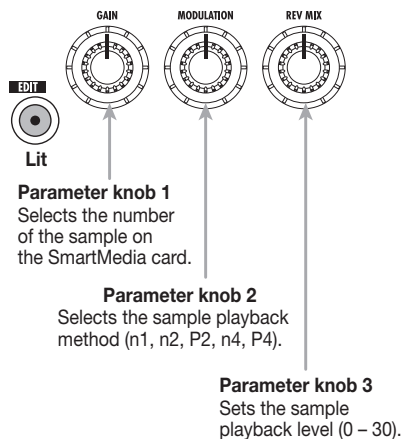

## HINT

For details regarding playback mode, see p. 14.

5. Use parameter knobs 1 – 3 to select the sample number, playback method, and playback level.

If you want to check out the sample, press the [SAMPLER] key to activate the sampler mode, and press the [▼] foot switch to play the currently selected sample.

**6. Press the [STORE/EXECUTE] key to store the patch.**

Assign other samples to other patches in the same way.

**7. When all patches have been prepared, select a patch in play mode to which a sample was assigned.**

**8. Press the [SAMPLER] key to activate the sampler mode.**

For a patch where the expression pedal is assigned to SAMPLER, you can also push the expression pedal fully down to set the sampler function to ON.

**9. Press the [▼] foot switch.**

The sample assigned to the patch is played.

**10. Use the MODULE [◀]/[▶] keys, and [▼]/[▲] foot switches to control play/stop/rewind/fast-forward.**

**11. Press the [SAMPLER] key to turn the sampler mode off.**

## Using SmartMedia card (Utility Mode)

A SmartMedia card inserted in the 707II can hold up to five groups of patches and 60 samples. This section describes the utility mode that provides various SmartMedia card related functions.

### Basic utility mode operation steps

The steps for various utility mode functions are similar, as described below.

**1. Verify that a SmartMedia card is inserted in the card slot.**

When a SmartMedia card is inserted, the [SMART MEDIA] LED is lit. (For information on how to insert a SmartMedia card, see p. 6.)

**2. In play mode, press the [UTILITY] key.**

The 707II enters the utility mode. The indication "LOAD" appears on the display.

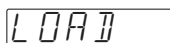

**3. Use the TYPE [▼]/[▲] keys to call up the desired function.**

The utility mode comprises the following functions.

- **LOAD (Load patch)**  
Loads a single patch stored on a SmartMedia card into the memory of the unit (USER group).
- **SAVE (Save patch)**  
Stores a single patch from the memory of the unit (USER group) on a SmartMedia card.
- **ALLOAD (Load patch group)**  
Loads an entire patch group stored on a SmartMedia card into the memory of the unit (USER group).
- **ALSAVE (Save patch group)**  
Stores all patches of the USER group from the memory of the unit on a SmartMedia card.
- **P DEL (Delete patch group)**  
Deletes a patch group stored on a SmartMedia card.
- **SP DEL (Delete sample)**  
Deletes a sample stored on a SmartMedia card.
- **FORMAT**  
Formats a SmartMedia card card.

#### 4. Press the [STORE/EXECUTE] key.

The setting screen for the function selected in step 3 appears.

The subsequent steps depend on the selected function. For details, see the respective sections.

### Utility mode functions

#### Storing a single patch on a SmartMedia card

You can store a single patch from the internal memory of the 707II on a SmartMedia card.

##### 1. In play mode, select the patch from internal memory that you want to store.

A patch that is currently being edited cannot be stored on the SmartMedia card. You must store the patch in internal memory first.

##### 2. Activate utility mode and select "SAVE". Then press the [STORE/EXECUTE] key.

The indication "GROUP" appears on the display, and the [BANK/PATCH] indicator shows the group number (1 – 5) for storing. If a "\*" is shown after "GROUP", there are patches stored in that group.

##### 3. Use the TYPE [▼]/[▲] keys to select the patch group (1 – 5) for storing, and then press the [STORE/EXECUTE] key.

One SmartMedia card can hold up to five patch groups (with 60 patches per group). Pressing the [STORE/EXECUTE] key confirms the store target group. The indication "SAVE" appears on the display, and the [BANK/PATCH] indicator shows the store target bank (A – F) and patch number (0 – 9).

##### 4. Use the TYPE [▼]/[▲] keys and [▼]/[▲] foot switches to select the desired bank (A – F) and patch number (0 – 9) in the patch group.

##### 5. Press the [STORE/EXECUTE] key.

The indication "SURE?" appears on the display.

##### 6. To carry out the operation, press the [STORE/EXECUTE] key once more.

The single patch is stored on the SmartMedia card. When the process is completed, the unit reverts to play mode.

If you press the [CANCEL/EXIT] key instead of the [STORE/EXECUTE] key, the store operation is canceled.

#### NOTE

- Any patch that is present in the target location on the SmartMedia card will be overwritten. Take care not to accidentally overwrite a patch that you want to keep.
- Never insert or remove the SmartMedia card while power to the unit is turned on. Otherwise all data on the card may be lost.
- If the target group is empty, all patches of the USER group are stored.

#### Loading a single patch from a SmartMedia card

You can load a single patch from a SmartMedia card into the internal memory of the 707II.

##### 1. In play mode, select the patch in internal memory into which you want to load the patch.

##### 2. Activate utility mode and select "LOAD". Then press the [STORE/EXECUTE] key.

The indication "GROUP" appears on the display, and the [BANK/PATCH] indicator shows the group number (1 – 5) from which to load.

##### 3. Use the TYPE [▼]/[▲] keys to select the patch group (1 – 5) on the SmartMedia card from which to load, and then press the [STORE/EXECUTE] key.

The indication "LOAD" appears on the display,

---

and the [BANK/PATCH] indicator shows the load source bank (A – F) and patch number (0 – 9).

**4. Press the [STORE/EXECUTE] key.**

The indication "SURE?" appears on the display.

**5. To carry out the operation, press the [STORE/EXECUTE] key once more.**

The single patch is loaded from the SmartMedia card into the memory of the unit. When the process is completed, the unit reverts to play mode.

If you press the [CANCEL/EXIT] key instead of the [STORE/EXECUTE] key, the load operation is canceled.

**NOTE**

- Any patch that is present in the target location will be overwritten. Take care not to accidentally overwrite a patch that you want to keep.
- Never insert or remove the SmartMedia card while power to the unit is turned on. Otherwise all data on the card may be lost.

### Storing a group on a SmartMedia card

You can store the USER group of the 707II on a SmartMedia card as a patch group.

**1. In utility mode, select "ALSAVE" and press the [STORE/EXECUTE] key.**

The indication "GROUP" appears on the display, and the [BANK/PATCH] indicator shows the group number (1 – 5) for storing.

**2. Use the TYPE [▼]/[▲] keys to select the patch group (1 – 5) for storing, and then press the [STORE/EXECUTE] key.**

The indication "SURE?" appears on the display.

**3. To carry out the operation, press the [STORE/EXECUTE] key once more.**

The entire USER group of the 707II is stored on the SmartMedia card. When the process is completed, the unit reverts to play mode.

If you press the [CANCEL/EXIT] key instead of the [STORE/EXECUTE] key, the store operation is canceled.

**NOTE**

Any patch group that was stored on the SmartMedia card in that position will be overwritten. Be careful not to overwrite a group that you wish to keep.

### Loading a group from a SmartMedia card

You can load a patch group stored on a SmartMedia card into the memory of the unit.

**1. In utility mode, select "ALLOAD" and press the [STORE/EXECUTE] key.**

The indication "GROUP" appears on the display, and the [BANK/PATCH] indicator shows the group number (1 – 5) for loading.

**2. Use the TYPE [▼]/[▲] keys to select the patch group (1 – 5) for loading, and then press the [STORE/EXECUTE] key.**

The indication "SURE?" appears on the display.

**3. To carry out the operation, press the [STORE/EXECUTE] key once more.**

The entire selected patch group is loaded from the SmartMedia card into the USER group of the 707II. When the process is completed, the unit reverts to play mode.

If you press the [CANCEL/EXIT] key instead of the [STORE/EXECUTE] key, the load operation is canceled.

**NOTE**

All patches currently stored in the USER group of the unit will be overwritten. Take care not to accidentally overwrite patches that you want to keep.

## Deleting a group from a SmartMedia card

You can delete any group stored on a SmartMedia card.

1. In utility mode, select "P DEL" and press the [STORE/EXECUTE] key.

The indication "GROUP" appears on the display, and the [BANK/PATCH] indicator shows the group number (1 – 5) for deleting.

2. Use the TYPE [▼]/[▲] keys to select the patch group (1 – 5) for deleting.

3. Press the [STORE/EXECUTE] key.

The indication "SURE?" appears on the display.

4. To carry out the operation, press the [STORE/EXECUTE] key once more.

The entire selected patch group is deleted from the SmartMedia card. When the process is completed, the unit reverts to play mode.

If you press the [CANCEL/EXIT] key instead of the [STORE/EXECUTE] key, the delete operation is canceled.

### NOTE

A deleted group cannot be restored. Take care not to accidentally delete a group that you want to keep.

## Deleting a sample from a SmartMedia card

You can delete any sample that was stored on a SmartMedia card while using the sampler function.

### NOTE

No special steps must be performed by the user for storing samples on a SmartMedia card. Samples are stored automatically when the SmartMedia card is inserted and the sampler function is used.

1. In utility mode, select "SP DEL" and press the [STORE/EXECUTE] key.

The indication "SP NO" appears on the display, and the [BANK/PATCH] indicator shows the sample number (1 – 60) for deleting.

2. Use the TYPE [▼]/[▲] keys to select the sample to erase from the SmartMedia card.

3. Press the [STORE/EXECUTE] key.

The indication "SURE?" appears on the display.

4. To carry out the operation, press the [STORE/EXECUTE] key once more.

The selected sample is deleted from the SmartMedia card. When the process is completed, the unit reverts to play mode.

If you press the [CANCEL/EXIT] key instead of the [STORE/EXECUTE] key, the delete operation is canceled.

### NOTE

A deleted sample cannot be restored. Take care not to accidentally delete a sample that you want to keep.

## Formatting a SmartMedia card

"Formatting" is the process of preparing a medium such as SmartMedia card for reading and writing data. Before an off-the-shelf SmartMedia card can be used in the 707II, it must first be formatted in the unit.

1. In utility mode, select "FORMAT" and press the [STORE/EXECUTE] key.

The indication "EXEC?" appears on the display.

2. Press the [STORE/EXECUTE] key once more.

The indication "SURE?" appears on the display.

---

### 3. To carry out the operation, press the [STORE/EXECUTE] key once more.

The formatting process starts. When the process is completed, the unit reverts to play mode.

If you press the [CANCEL/EXIT] key instead of the [STORE/EXECUTE] key, the formatting operation is canceled.

#### **NOTE**

Formatting erases all data that may be present on the SmartMedia card. Take care not to accidentally format a card which already contains data that you want to keep.

### SmartMedia card error messages

While using a SmartMedia card, one of the following error indications may appear. The meaning is explained below.

- **[SMART MEDIA] LED does not light**  
A SmartMedia card with a capacity of less than 8 MB may have been inserted.

- **ERROR**
  - The card was removed or inserted (during sampler operation).
  - The card was removed (in utility mode).
- **WP ERR**  
A write protect seal is attached to the SmartMedia card. This prevents writing to the card.
- **FULL**  
There is not enough free capacity on the SmartMedia card.
- **NODATA**
  - There are no sampler data (during sampler operation).
  - There are no patch data or sampler data (in utility mode).
- **NO USR**  
Loading cannot be performed, because the load target is not the USER group (in utility mode).
- **NO CARD**  
SmartMedia card is not inserted.
- **CD ERR**  
The card is defective, not inserted correctly, or not properly formatted.

## All Initialize/Factory Recall

The patches in the USER group can be returned to the original condition at any time, even if you have changed them.

The All Initialize function returns all patches in the USER group to the default condition. Factory Recall can be used to reset only specific patches in the USER group to the default settings.

### 1. Turn power to the 707II on while pressing the [STORE/EXECUTE] key.

The indication "ALINIT" appears on the display.

- To perform All Initialize, proceed to step 2.
- To perform Factory Recall, use the TYPE [▼]/[▲] keys and [▼]/[▲] foot switches to select the patch that you want to return to the factory default condition. (The bank and patch number are shown on the [BANK/PATCH] indicator.)

### 2. Press the [STORE/EXECUTE] key once more.



All Initialize or Factory Recall is carried out. If All Initialize was carried out, the unit automatically returns to the play mode.

The contents of patches stored by the user will be lost when the defaults are restored. To cancel All Initialize/Factory Recall, press the [CANCEL/EXIT] key before step 2.



# Effect Types and Parameters

In this section, all effect types and parameters of the modules in the 707II are explained.

The  symbol indicates a parameter that is assigned to the expression pedal and can be changed by moving the pedal (→ p. 23). The symbols  –  indicate the parameters that can be controlled by parameter knobs 1 – 3 in play mode.

## BOOSTER Module

This module amplifies the input signal. The amount of boost can be set to Low (1) or High (2).

### TYPE 1 BOOSTER

#### Parameter 1 GAIN

1, 2

Selects boost setting.

## ISOLATOR/COMP (Isolator/Compressor) Module

The isolator allows cutting or emphasizing a particular band. The compressor serves to reduce excessive signal levels.

### TYPE 1 COMP (Compressor)

Universal type compressor that controls attack rate in two stages.

#### Parameter 1 ATTACK(FAST/SLOW) FS, SL

Adjusts time interval from signal onset to start of compression.

#### Parameter 2 SENS 0 – 10

Adjusts compressor sensitivity.

#### Parameter 3 LEVEL 1 – 8

Adjusts signal level after passing module.

### TYPE 2 ISOLTR (Isolator)

Isolator that allows cutting or emphasizing a particular band. There are two pages with parameters. Use the [EDIT] key to switch between pages.

#### ■ PAGE 1

#### Parameter 1 HIGH OFF, -12 – 12

Adjusts high-range mix.

#### Parameter 2 MID OFF, -12 – 12

Adjusts midrange mix.

#### Parameter 3 LOW OFF, -12 – 12

Adjusts low-range mix.

#### ■ PAGE 2

#### Parameter 1 FREQ L 5 – 8.0, 0.0 (5=50Hz, 8.0=8kHz, 0.0=10kHz)

Adjusts crossover frequency for low and mid range.

#### Parameter 2 FREQ H 5 – 8.0, 0.0

Adjusts crossover frequency for mid and high range.

#### Parameter 3 LEVEL 1 – 8

Adjusts signal level after passing module.

## DRIVE Module

This module comprises 30 types of distortion and acoustic simulator effects. The [DRIVE] knob allows choosing the amplifier or compact effect type, and the [DRIVE VARIATION] key allows choosing the tone or distortion variation.

### TYPE 1 FDR

#### CLASSIC FD BLU

Classic bluesy sound of a built-in tube amp

#### STANDARD FD CLN

Clean sound of a built-in tube amp

#### MODERN FD DRV

Drive sound of a built-in tube amp

### TYPE 2 MS

#### CLASSIC MS OLD

Old-style sound of a British tube stack amp

#### STANDARD MS CRU

Crunch sound of a British tube stack amp

#### MODERN MS DRV

Drive sound of a British tube stack amp

### TYPE 3 BG

#### CLASSIC BG OLD

Old-style sound of a tube combo amp with gutsy midrange

#### STANDARD BG DRV

Drive sound of a tube stack amp with gutsy midrange

#### MODERN BG MTL

Metal sound of a tube stack amp with gutsy midrange

### TYPE 4 CLEAN

#### CLASSIC VX CRU

Old-style crunch sound

#### STANDARD JAZZ C

Clean and bright combo amp sound

#### MODERN MACH

Warm and powerful combo amp sound

**TYPE 5 HI-GAIN****CLASSIC MP 1**

High-gain tube preamp sound

**STANDARD PV DRV**

Tube stack amp sound for heavy metal

**MODERN SL DRV**

Warm and modern tube stack amp sound

**TYPE 6 ZOOM (ZOOM original effects)****CLASSIC 9002**

ZOOM's original 9002 type sound

**STANDARD Z LEAD**

ZOOM's traditional rich lead sound

**MODERN Z PWR**

ZOOM's original powerful amp type sound

**TYPE 7 OVER DRIVE****CLASSIC V-OD**

Dry overdrive sound

**STANDARD OD**

Overdrive sound with cabinet character

**MODERN PD 1**

Overdrive sound with wide application range, from booster to hard distortion

**TYPE 8 DIST****CLASSIC V-DIST**

Characteristic dry distortion sound

**STANDARD TB DST**

Distortion sound with extreme signal boost

**MODERN HP DST**

Extreme distortion sound

*\* Parameters for TYPE 1 - 8 are the same.***Parameter 1** GAIN  1 - 30

Adjusts distortion intensity.

**Parameter 2** TONE 0 - 10

Adjusts tone.

**Parameter 3** LEVEL 1 - 8

Adjusts signal level after passing module.

**TYPE 9 FUZZ****CLASSIC WILDFZ**

Older-style, high-gain aggressive fuzz sound

**STANDARD FUZZ**

Nostalgic sixties style standard fuzz sound

**MODERN UF 1**

ZOOM original fuzz sound with oscillation control

*\* For this type, the action of parameter 2 differs for WILDFZ/FUZZ and UF 1.***Parameter 1** GAIN  1 - 30

Adjusts distortion intensity.

**Parameter 2** (WILDFZ/FUZZ) TONE 0 - 10

Adjusts tone.

**Parameter 2** (UF1)  RESO 0 - 10

Adjusts sound character.

**Parameter 3** LEVEL 1 - 8

Adjusts signal level after passing module.

**TYPE 10 METAL****CLASSIC MTZ**

Traditional metal style sound with prominent midrange

**STANDARD METAL**

ZOOM's original metal sound with low range and high range boost

**MODERN MT 7TH**

Metal sound for 7-string guitar

**Parameter 1** GAIN  1 - 30

Adjusts distortion intensity.

**Parameter 2** TONE 0 - 10

Adjusts tone.

**Parameter 3** LEVEL 1 - 8

Adjusts signal level after passing module.

**TYPE 11 ACOUSTIC (Acoustic Simulator)****CLASSIC AC FAT****STANDARD AC STD****MODERN AC BRI**

Changes the sound of an electric guitar to that of an acoustic guitar. The [DRIVE VARIATION] key switches the tone (fat, standard, bright).

**Parameter 1** TOP  1 - 10

Adjusts characteristic acoustic guitar string sound.

**Parameter 2** BODY 1 - 10

Adjusts body resonance.

**Parameter 3** LEVEL 1 - 8

Adjusts signal level after passing module.

**EQ (Equalizer) Module**

This is a 4-band equalizer. There are two pages with parameters. Use the [EDIT] key to switch between pages.

**■ PAGE 1****Parameter 1** PRESEN -12 - 12

Adjusts boost/cut in high range (center frequency 8 kHz).

**Parameter 2** HIGH -12 - 12

Adjusts boost/cut in mid-high range (center frequency 3.125 kHz).

**Parameter 3** MIDDLE -12 - 12

Adjusts boost/cut in midrange (center frequency 800 Hz).

**■ PAGE 2****Parameter 1** LOW F 1, 2

Selects center frequency for low range. 1 = 63 Hz, 2 = 125 Hz.

**Parameter 2** **LOW G** -12 - 12  
Adjusts boost/cut in low range selected with LOW F.

**Parameter 3** **LEVEL** 1 - 8  
Adjusts signal level after passing equalizer module.

## ZNR/D GATE (ZOOM Noise Reduction/D Gate) Module

This module serves for cutting noise during play pauses. It offers a choice of noise reduction that lowers only noise and a noise gate that cuts the sound off completely.

### TYPE 1 ZNR (ZOOM Noise Reduction)

The original noise reduction developed by ZOOM cuts noise during performance pauses without impairing the sound quality.

### TYPE 2 D GATE

Vintage type noise gate with distinctive closure characteristics.

**Parameter 1** 1 - 8  
Adjusts sensitivity. Set the value for maximum noise reduction without producing an unnatural cut of the instrument sound.

## CABINET Module

Simulates the sound of a speaker cabinet.

### TYPE 1 BOX

Simulates a small amp cabinet.

### TYPE 2 Z BOX (ZOOM Box)

Simulates a cabinet with ZOOM's original sound character.

### TYPE 3 BR CMB (Bright Combo)

Simulates a bright combo amp cabinet.

### TYPE 4 CMB (Combo)

Simulates a conventional combo amp cabinet.

### TYPE 5 CMB+EV (Combo + EV)

Simulates an EV speaker in a combo amp cabinet.

### TYPE 6 STK (Stack)

Simulates a stack amp cabinet.

### TYPE 7 STK+EV (Stack + EV)

Simulates an EV speaker in a stack amp cabinet.

\* Parameters for TYPE 1 - 7 are the same.

**Parameter 1** **DEPTH** 0 - 10  
Adjusts the intensity of the cabinet effect.

## MODULATION Module

This module contains modulation type effects such as chorus and flanger, effects that drastically change the sound such as wow, filter, and ring modulator, and pitch altering effects such as pitch shift and vibrato.

### TYPE 1 CHORUS

Adds vibration and spaciousness to the sound.

**Parameter 1** **DEPTH** 0 - 10  
Adjusts modulation intensity.

**Parameter 2** **RATE** 1 - 30  
Adjusts modulation speed.

**Parameter 3** **MIX**  0 - 30  
Adjusts mixing balance of direct sound and effect sound.

### TYPE 2 V-CHO (Vintage Chorus)

Simulates the warm sound of a vintage effect.

**Parameter 1** **DEPTH** 0 - 10  
Adjusts modulation intensity.

**Parameter 2** **RATE**  1 - 30  
Adjusts modulation speed.

**Parameter 3** **MIX**  0 - 30  
Adjusts mixing balance of direct sound and effect sound.

### TYPE 3 FLANGE (Flanger)

Produces a unique, undulating sound.

**Parameter 1** **DEPTH** 0 - 10  
Adjusts modulation intensity.

**Parameter 2** **RATE**  1 - 30  
Adjusts modulation speed.

**Parameter 3** **FB** -10 - 10  
Adjusts feedback ratio. Higher values in positive or negative direction result in stronger characteristics.

### TYPE 4 PHASE (Phaser)

Produces a swooshing sound.

**Parameter 1** **POSI** AF, bF

Selects connection point of MOD module.

- AF: After CABINET module
- bF: Before DRIVE module



**Parameter 2** **RATE**  1 - 30  
Adjusts modulation speed.

**Parameter 3** COLOR  1-4  
Selects sound character.

### TYPE 5 TREMOL (Tremolo)

Periodically varies the level of the sound.

**Parameter 1** DEPTH  0-10  
Adjusts modulation intensity.



**Parameter 2** RATE   1-30  
Adjusts modulation speed.

**Parameter 3** CLIP  0-10  
Adjusts modulation waveform clip. Larger values result in more intense modulation.

### TYPE 6 A-PAN (Auto-Pan)

This stereo panning effect periodically moves the sound back and forth between right and left when two amplifiers are used. When one amplifier is used, the effect is a tremolo effect.

**Parameter 1** WIDTH  0-10  
Adjusts effect width.

**Parameter 2** RATE   1-30  
Adjusts modulation speed.

**Parameter 3** CLIP  0-10  
Adjusts modulation waveform clip. Larger values result in more intense modulation.



### TYPE 7 A-WAH (Auto Wah)

This effect gives a varying wah sound that depends on the picking intensity.

**Parameter 1** POSI  AF, bF  
Selects connection point of MOD module.

- AF: After CABINET module
- bF: Before DRIVE module

**Parameter 2** RESO  1-10  
Adjusts wah effect intensity

**Parameter 3** SENS   -10 -1, 1-10  
Adjusts sensitivity. Negative values result in downward wah.

### TYPE 8 P-WAH (Pedal Wah)

This effect lets you control wah with the expression pedal.

**Parameter 1** POSI  AF, bF  
Selects connection point of MOD module.

- AF: After CABINET module
- bF: Before DRIVE module



**Parameter 2** FREQ  1-10  
Adjusts wah effect center frequency.

**Parameter 3** DIRMIX  0-10  
Adjusts direct sound mix.

### TYPE 9 STEP

This is a special effect with step-like filter characteristics.

**Parameter 1** DEPTH  0-10  
Adjusts modulation intensity.

**Parameter 2** RATE   1-30  
Adjusts modulation speed.

**Parameter 3** RESO  0-10  
Adjusts wah effect intensity.

### TYPE 10 PITCH (Pitch Shifter)

This is a pitch shifter with a range of 2 octave up and 1 octaves down.

**Parameter 1** SHIFT  -12 -1, dt, 1-12, 24  
Sets the pitch shift amount. The "dt" setting results in a detune effect.



**Parameter 2** TONE  0-10  
Adjusts effect tone.

**Parameter 3** BAL  0-30  
Adjusts balance between direct sound and effect sound. Higher values emphasize effect sound.

### TYPE 11 P-PIT (Pedal Pitch)

This effect lets you vary the pitch in real time, using the expression pedal.

**Parameter 1** TYPE  1-16  
Selects the pedal pitch type. Depending on the type, the pitch differs when pushing the pedal down or when raising it.

		 Pedal minimum value	Pedal maximum value 
P-PIT TYPE	1	-100 cent	Original sound only
	2	Original sound only	-100 cent
	3	DOUBLING	Detune + DRY
	4	Detune + DRY	DOUBLING
	5	0 cent	+1 octave
	6	+1 octave	0 cent
	7	0 cent	-2 octaves
	8	-2 octaves	0 cent
	9	-1 octave + DRY	+1 octave + DRY
	10	+1 octave + DRY	-1 octave + DRY
	11	-700 cent + DRY	500 cent + DRY
	12	500 cent + DRY	-700 cent + DRY
	13	-∞ (0 Hz) + DRY	+1 octave
	14	+1 octave	-∞ (0 Hz) + DRY
	15	-∞ (0 Hz) + DRY	+1 octave + DRY
	16	+1 octave + DRY	-∞ (0 Hz) + DRY

**Parameter 2** TONE  0-10  
Adjusts effect tone.

### TYPE 12 RING M (Ring Modulator)

Produces a metallic sound.

**Parameter 1** POSI  AF, bF  
Selects connection point of MOD module.

- AF: After CABINET module
- bF: Before DRIVE module

**Parameter 2** RATE  1-30  
Sets frequency for ring modulation effect.

The tone changes depending on the frequency setting.

**Parameter 3** BAL  0-30  
Adjusts balance between direct sound and effect sound.

### TYPE 13 SLOW-A (Slow Attack)

This effect automatically creates a "violin playing" sound.

**Parameter 1** POSI  AF, bF  
Selects connection point of MOD module.

- AF: After CABINET module
- bF: Before DRIVE module

**Parameter 2** TIME   1-30  
Adjusts attack speed.

**Parameter 3** CURVE  1-10  
Adjusts attack curve.

**TYPE 14 FILTER**

This effect tracks the picking action and controls filter opening accordingly.

**Parameter 1** POSI AF, bF

Selects connection point of MOD module.

- AF: After CABINET module
- bF: Before DRIVE module

**Parameter 2** TIME  1 - 30

Adjusts filter attack speed.

**Parameter 3** RANGE 1 - 10

Sets adjustable filter range.

**TYPE 15 DELAY**

Delay effect with a delay time of up to 500 milliseconds.

**Parameter 1** TIME 1 - 50

Adjusts delay time in 10-ms steps.

**Parameter 2** FB 0 - 10

Adjusts number of repeat cycles (feedback) for delay sound.

**Parameter 3** MIX  0 - 30

Adjusts effect sound level.

**TYPE 16 ECHO**

Long delay effect (up to 2 seconds) with warm sound.

**Parameter 1** TIME  1 - 50

Adjusts delay time in 10-ms steps up to 1 second and in 100-ms steps up to 2 seconds.

**Parameter 2** FB 0 - 10

Adjusts number of repeat cycles (feedback) for delay sound.

**Parameter 3** MIX  0 - 30

Adjusts effect sound level.

**TYPE 17 T-TRIP (Time Trip)**

This delay effect varies the delay time according to the picking intensity.

**Parameter 1** SENS  1 - 50

Adjusts effect sensitivity.

**Parameter 2** FB -10 - 10

Adjusts number of repeat cycles (feedback) for delay sound.

**Parameter 3** BAL 0 - 30

Adjusts balance between direct sound and effect sound.

**TYPE 18 TRMCHO (Tremolo + Chorus)**

This is a combined tremolo and chorus effect.

**Parameter 1** TRMRAT  1 - 30

Adjusts tremolo speed.

**Parameter 2** CHORAT 1 - 30

Adjusts modulation speed of chorus effect.

**Parameter 3** CHOMIX  0 - 30

Adjusts chorus sound mix.

**TYPE 19 RINVIB (Ring Modulator + Vibrato)**

This is a combined ring modulator and vibrato effect.

**Parameter 1** RINRAT 1 - 30

Adjusts ring modulation effect frequency.

**Parameter 2** VIBRAT  1 - 30

Adjusts vibrato effect speed.

**Parameter 3** VIBDEP  0 - 10

Adjusts vibrato effect depth.

**TYPE 20 VIBE (Vibrato)**

This is an automatic vibrato effect.

**Parameter 1** DEPTH 0 - 10

Adjusts effect depth.

**Parameter 2** RATE  1 - 30

Adjusts effect speed.

**Parameter 3** BAL  0 - 30

Adjusts balance between direct sound and effect sound.

**DLY/REV (Delay/Reverb) Module**

This module comprises various spatial effects including delay and reverb.

**TYPE 1 HALL (Hall Reverb)**

This is a reverb effect which simulates the acoustics of a concert hall.

**TYPE 2 ROOM (Room Reverb)**

This is a reverb effect which simulates the acoustics of a room.

**TYPE 3 SPRING (Spring Reverb)**

This is a reverb effect which simulates a spring type reverb machine.

\* Parameters for TYPE 1 - 3 are the same.

**Parameter 1** TIME 1 - 30

Adjusts reverb duration (reverb time).

**Parameter 2** TONE 0 - 10

Adjusts effect tone.

**Parameter 3** MIX  0 - 30

Adjusts reverb sound mix.

**TYPE 4 MN-DLY (Mono delay)**

This is a monaural delay with a duration of up to 1.5 seconds.

**TYPE 5 PP-DLY (Ping-Pong Delay)**

When two amplifiers are used, this serves as a ping-pong delay effect with a duration of up to 1.5 seconds. When one amplifier is used, the effect is a mono delay.

\* Parameters for TYPE 4 and 5 are the same.

**Parameter 1** TIME 1 - 99, 1.0 - 1.5

Adjusts delay time from 10 ms to 990 ms in 10-ms steps (1 - 99), and over 1 second in 100-ms steps (1.0 - 1.5).

**Parameter 2** **FB** 0 - 10  
 Adjusts number of repeat cycles (feedback) for delay sound.

**Parameter 3** **MIX**  0 - 30  
 Adjusts delay sound level.

**TYPE 6 DLYHAL (Delay + Hall Reverb)**

This is a combined delay and hall reverb effect.

**TYPE 7 DLYROM (Delay + Room Reverb)**

This is a combined delay and room reverb effect.  
 \* Parameters for DLYHAL and DLYROM are the same.

**Parameter 1** **DLYTIM** 1 - 50  
 Adjusts delay time in 10-ms steps.

**Parameter 2** **DLYMIX**  0 - 15  
 Adjusts delay sound mix.

**Parameter 3** **REVMIX**  0 - 15  
 Adjusts reverb sound mix.

**TYPE 8 HLDDLY (Hold Delay)**

This is a hold delay effect that lets you record a phrase of up to 2 seconds during a performance and play it back repeatedly.  
 When "Mn" (Manual) is selected and a foot switch is pressed, recording is carried out until the switch is pressed again or until 2 seconds have elapsed.

**Parameter 1** **TIME** 1 - 99, 1.0 - 2.0, Mn  
 Adjusts recording time from 10 ms to 990 ms in 10-ms steps (1 - 99), and from 1.0 to 2.0 seconds in 100-ms steps (1.0 - 2.0). When "Mn" (Manual) is selected, recording is carried out for as long as a foot switch is depressed (up to the maximum of 2 seconds).

**Parameter 2** **MODE** nL, So, rS  
 Selects playback mode for recorded phrase.

- nL (Normal): Normal direction playback
- So (Sound-on-sound): Recorded contents are played back repeatedly to create an overlay.
- rS (Reverse): Reverse direction playback

**Parameter 3** **MIX** 0 - 30  
 Adjusts effect sound mix.

**TOTAL Module**

The TOTAL module is not an independent effect module. Rather it serves to set parameters that affect all patches or the entire 707II. There are three pages with parameters. Use the [EDIT] key to switch between pages.

**■ PAGE 1**

**Parameter 1** **PATLVL** 1 - 30  
 Sets final patch level. A setting of 25 means that input signal and output signal levels are equal.

**Parameter 2** **Specifies input position.**

**Parameter 3** **Selects a character.**

Parameter knobs 2 and 3 let you input or edit a patch name. Knob 2 specifies the character input position, and knob 3 selects the alphanumeric character to be input at that position.

(Space)	/	<	>	✖	+	-	/	0	1	2	3	4
(Space)	'	(	)	*	+	-	/	0	1	2	3	4
S	G	7	B	9	L	=	\	P	Q	R	S	C
5	6	7	8	9	<	=	>	@	A	B	C	
Q	E	F	G	H	I	J	K	L	M	N	O	P
D	E	F	G	H	I	J	K	L	M	N	O	P
Q	R	S	T	U	V	W	X	Y	Z	\		
Q	R	S	T	U	V	W	X	Y	Z	\		

**■ PAGE 1**

**Parameter 1** **PTN** Pattern name  
 Selects rhythm pattern to be assigned to a patch. For details on how to assign rhythm patterns to a patch, see p. 26.

**Parameter 2** **PDLMIN** 0 - 10  
 Sets minimum parameter value when expression pedal is fully raised.

**Parameter 3** **PDLMAX** 0 - 10  
 Sets maximum parameter value when expression pedal is fully lowered.  
 For details on how to set the pedal range for each patch, see p. 23.

**■ PAGE 3**

**Parameter 1** **SP NO** 1 - 60  
 Selects a sample to assign to a patch. For details on how to assign a sample to a patch, see p. 27.

**Parameter 2** **SPMODE** n1, n2, P2, n4, P4  
 Selects the sample playback mode, as follows.

- n1 Normal speed playback
- n2 Half tempo, half pitch playback
- P2 Half tempo, normal pitch playback
- n4 Quarter tempo, quarter pitch playback
- P4 Quarter tempo, normal pitch playback

**Parameter 3** **SP LVL** 0 - 30  
 Adjusts sample playback level.

# Troubleshooting

## ■ No sound, or very low volume

- Is the correct AC adapter connected, and the power switch set to ON?

Refer to "Getting Connected" on page 7 and turn the power on.

- Are [INPUT] jack and [OUTPUT/PHONES] jack connected correctly to the instrument and amplifier?  
Refer to "Getting Connected" on page 7 and establish correct connections. Check volume settings at instrument and amplifier.
- Is the shielded cable defective?  
Try replacing the cable.
- Is 707II set to mute condition?  
Cancel the mute condition.
- Is [OUTPUT] knob turned down?  
Set knob to suitable position.
- Is expression pedal raised?  
For some patches, the expression pedal controls the volume. Set it to a suitable position.

## ■ Cannot record from [AUX IN] jack

Is input source set to "GT"? Set it to "AUX".

## ■ Sound is unnaturally distorted

- Adjust level and gain parameters of modules.
- Set BOOSTER or COMP/ISOLATOR to OFF.
- When a guitar with high output is used with the above effects, unwanted distortion may occur depending on DRIVE module effect type.

## ■ High noise levels

- Adjust ZNR parameter. If problem persists, try reducing GAIN.
- If BOOSTER or COMP/ISOLATOR module is used, lower GAIN parameter of DRIVE module.

## ■ Cannot play rhythm pattern or volume is very low

- Is rhythm volume set to low value?  
Adjust parameter knob 3 to obtain suitable volume.

## ■ Expression pedal on/off switching does not work properly.

- Try the procedure described in "Adjusting the Expression Pedal" on page 25.

## ■ SmartMedia card cannot be used

- Is [SMART MEDIA] LED lit?  
Turn unit off and check whether SmartMedia card is inserted properly.
- Is correct SmartMedia card used?  
The 707II can use SmartMedia cards with a capacity from 16 to 128 MB (designed for 3.3V).
- Has SmartMedia card been formatted?  
Be sure to format the SmartMedia card in the 707II before use, as described on page 31.

# Specifications

◆ Effect Programs	74 types
◆ Effect Modules	6 modules + amp simulator + ZNR
◆ Sampler Function	Maximum recording duration 6 seconds (without SmartMedia) 16-bit linear record/playback (MOD and REV modules are temporarily turned off when sampler function is used)
◆ Patch Memory	USER: 6 banks x 10 = 60 (rewritable, with store) PRESET: 6 banks x 10 = 60 Total 120 patches
◆ Sampling Frequency	31.25 kHz
◆ A/D Conversion	20-bit, 64-times oversampling
◆ D/A Conversion	20-bit, 128-times oversampling
◆ Input	Guitar input: standard mono phone jack (nominal input level -20 dBm, input impedance 470 kilohms) AUX IN: miniature stereo phone jack (nominal input level -20 dBm, input impedance 20 kilohms)

◆ Output	Combined line/headphone output Standard stereo phone jack (maximum output level = +3 dBm with output load impedance of 10 kilohms or higher)
◆ Display	6-position alphanumeric LED display 2-position 7-segment LED display
◆ Power Requirements	AC adapter (available separately) 9 V DC, center minus, 300 mA (ZOOM AD-0006) Batteries: IEC R6 (size AA) x 4 Continuous operation: approx. 11 hours (with alkaline batteries)
◆ External Dimensions	249 mm (W) x 195 mm (D) x 57 mm (H)
◆ Weight	860 g (without batteries)

\* 0 dBm = 0.775 Vrms

\* Design and specifications subject to change without notice.

## Patch List

### BANK A DEMO

Patch	NAME		PEDAL
0	POWER	Powerful distortion sound	VOLUME
1	NUANCE	Overdrive sound great for fingerpicking	SPRING
2	FATCLN	Fat clean sound	GAIN
3	BARK	High-gain sound for hard rock	CHORUS
4	PEDWAH	Wild pedal sound	WAH
5	HYPER	Smooth, transparent sound	PITCH
6	OVERDR	Attractive overdrive sound	GAIN
7	BOOTS	Octaver type heavy sound	GAIN
8	CLNWAH	Clean wah sound	WAH
9	U-FUZZ	ZOOM compact fuzz sound	RESO

### BANK d LINE

Patch	NAME		PEDAL
0	L-DRV	Multi-use distortion sound	GAIN
1	D-FEEL	Overdrive line sound	SPRING
2	ACOUS	Acoustic line sound	HALL
3	L-FUNK	Funky line sound	PHASE
4	AUTO-W	Auto wah line sound	VOLUME
5	9002LD	ZOOM line sound	PP-DLY
6	BOX	Cabinet line sound	GAIN
7	JC CHO	Bright combo line sound	V-CHO
8	L-FUZY	Line fuzz sound	ECHO
9	L-BLUE	Bluesy line sound	GAIN

### BANK b COMPACT/PRE

Patch	NAME		PEDAL
0	MP 1	Vintage high-gain preamp sound	VOLUME
1	TS	Dry overdrive sound	ROOM
2	PD 1	ZOOM PD-01 sound	GAIN
3	FZFACE	Vintage fuzz sound	HALL
4	JMP	Modern high-gain preamp sound	VOLUME
5	MTZONE	Compact effect sound for metal	HALL
6	SD+CE	Vintage compact effect sound	V-CHO
7	ANADLY	Analog-like delay sound	SPRING
8	TURBO	Turbo boost distortion sound	VOLUME
9	OLDVIB	Nostalgic VIB tone	VIBE

### BANK E ARTIST

Patch	NAME		PEDAL
0	GARYBD	Gary style ballad solo sound	MN-DLY
1	BEAT	Mersey beat type crunch sound	GAIN
2	PAT-M	Metheny sound simulation	DLYHAL
3	VAI PT	Vai style pitch sound	PITCH
4	ARM	Pedal sound for solos	WAH
5	VHALEN	Heavy lead & backing sound	VOLUME
6	CATS	Rockabilly crunch sound	CHORUS
7	FUSION	Clean fusion sound	DLYHAL
8	SWEEP	Sweep sound	SPRING
9	12STR	12-string acoustic guitar sound	HALL

### BANK C MULTI/SFX

Patch	NAME		PEDAL
0	ZLEAD	The ultimate lead sound	VOLUME
1	FLANG	Solid clean flanging sound	FLANGE
2	HVYCMP	Tight compression sound	DLYROM
3	VIOLIN	Great for volume playing	GAIN
4	JET	Standard jet sound	FLANGE
5	TALK	Make the midrange talk	T-TRIP
6	WIND	Noise like the wind	RING-M
7	REVERS	Retro style reverse guitar sound	FILTER
8	TRILL	Tricky, thrilling sound	T-TRIP
9	STEP	ZOOM original step sound	VOLUME

### BANK F MODELING

Patch	NAME		PEDAL
0	MS9000	Majestic stack drive sound	VOLUME
1	USBLUS	American blues sound	SPRING
2	FD TWN	U.S. clean combo amp sound	VOLUME
3	MARK	Mark series combo amp sound	GAIN
4	SLDN	Heavy rock amp sound	GAIN
5	AMPDRV	Fat amp sound	VOLUME
6	MS OLD	Vintage MS sound	VOLUME
7	MACDRV	Modern clean crunch sound	GAIN
8	PV PWR	American hard rock sound	VOLUME
9	MT 7TH	7-string guitar heavy metal sound	PITCH



### ZOOM CORPORATION

NOAH Bldg., 2-10-2, Miyanishi-cho, Fuchu-shi, Tokyo 183-0022, Japan

PHONE: +81-42-369-7116 FAX: +81-42-369-7115

Web Site: <http://www.zoom.co.jp>