

The home of the turntable

# THE VINYL **ENGINE**®

For more turntable manuals and setup information  
please visit [www.vinylengine.com](http://www.vinylengine.com)

**“WARNING: TO PREVENT FIRE OR SHOCK HAZARD, DO NOT EXPOSE THIS APPLIANCE TO RAIN OR MOISTURE.”**

**Cautions for safest use of this apparatus**

**Caution:** This apparatus should be disconnected from the mains, when not in use.

**Warning**

This apparatus need not earth because of double insulation.

**Important**

**THE WIRES IN THIS MAINS LEAD ARE COLOURED IN ACCORDANCE WITH THE FOLLOWING CODE:**

- BLUE: NEUTRAL**
- BROWN: LIVE**

As the colours of the wires in the mains lead of this apparatus may not correspond with the coloured markings identifying the terminals in your plug proceed as follows.

The wire which is coloured **BLUE** must be connected to the terminal which is marked with the letter **N** or coloured **BLACK**. The wire which is coloured **BROWN** must be connected to the terminal which is marked with the letter **L** or coloured **RED**.

**Power source**

**LINE VOLTAGE SELECTOR:**

Be sure that the line voltage selector is correct to your local voltage before connecting the plug to the socket. DC power cannot be used.

If your local voltage is different, please turn the AC line voltage selector with a screw driver to your local voltage.

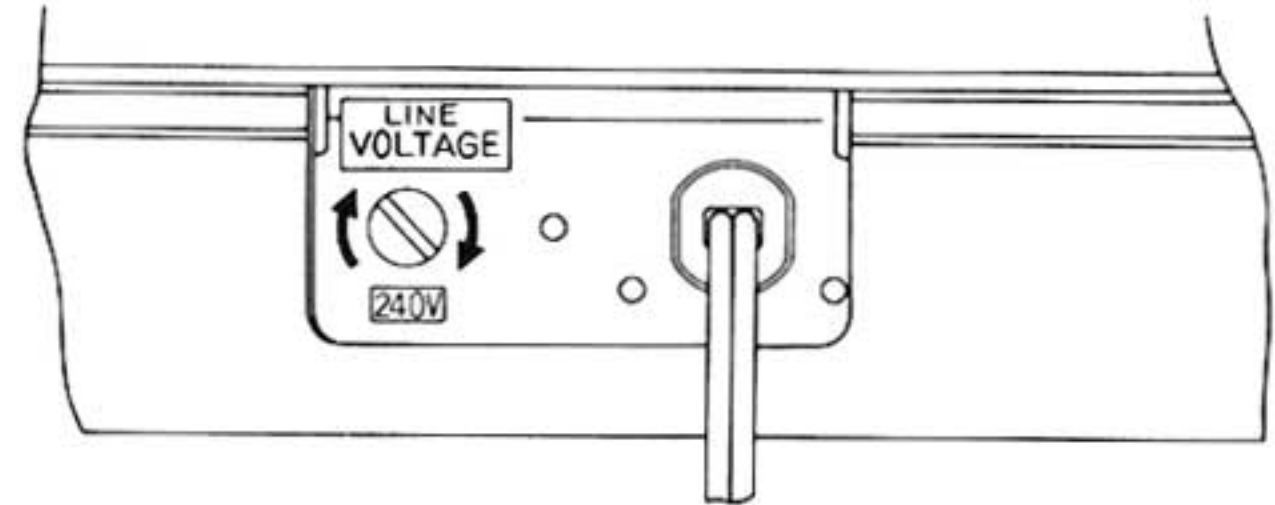

**Power supply** ..... ~ 110/120/220/240 V, 50 Hz or 60 Hz  
**Power consumption** .... 6 W

 **Technics**

**DIRECT DRIVE PLAYER SYSTEM**

**SL-1500**  
**SL-150**

**OPERATING INSTRUCTIONS**



This instruction manual covers both the SL-1500 and SL-150. The SL-150 is the same as the SL-1500 in every aspect, but comes only without tonearm section.

Read these instructions completely, before operating this set.

We want to thank you for selecting the SL-1500/SL-150, DIRECT DRIVE PLAYER SYSTEM. For optimum performance, we recommend that you read these instructions carefully.

## 1 PARTS IDENTIFICATION

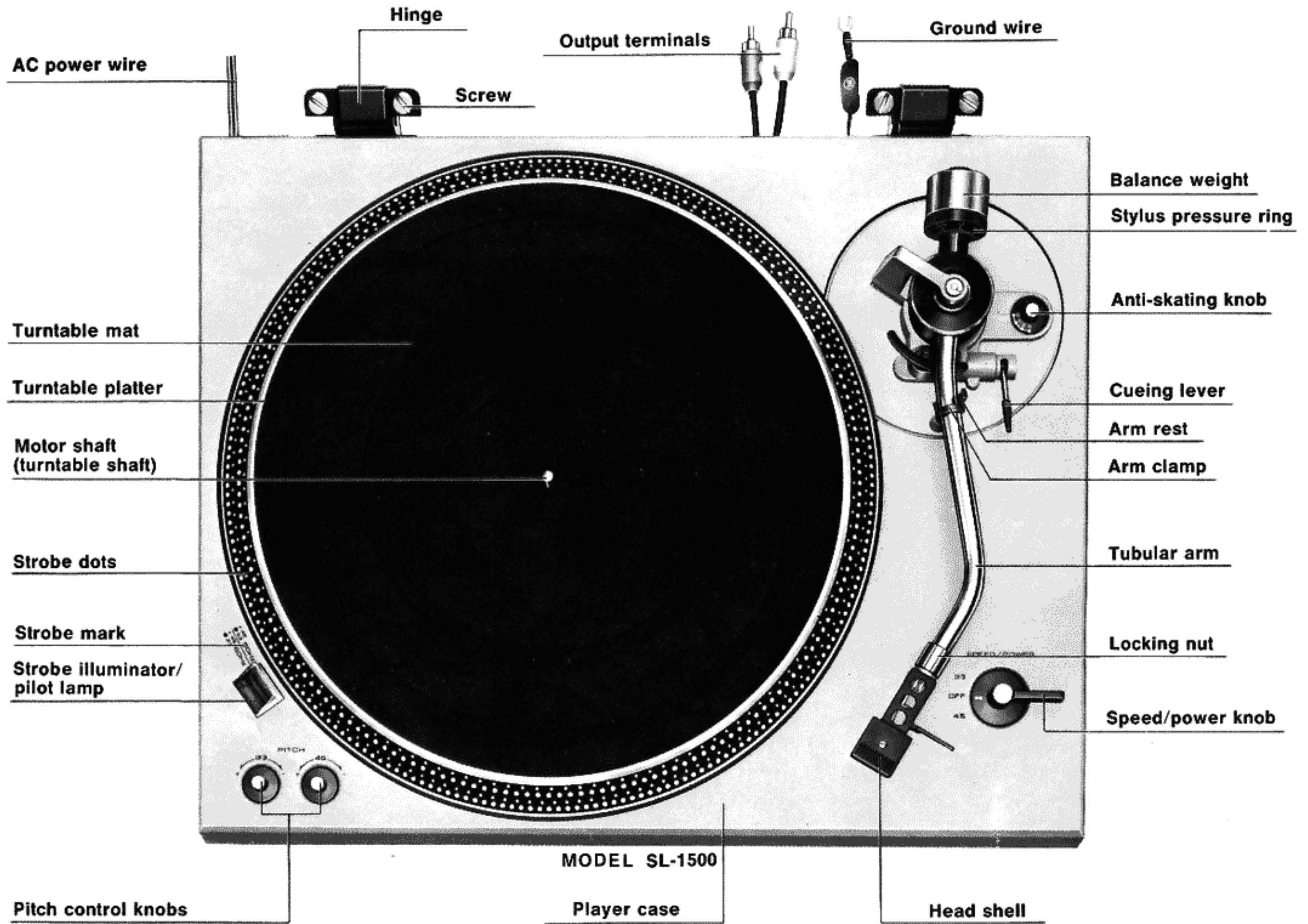
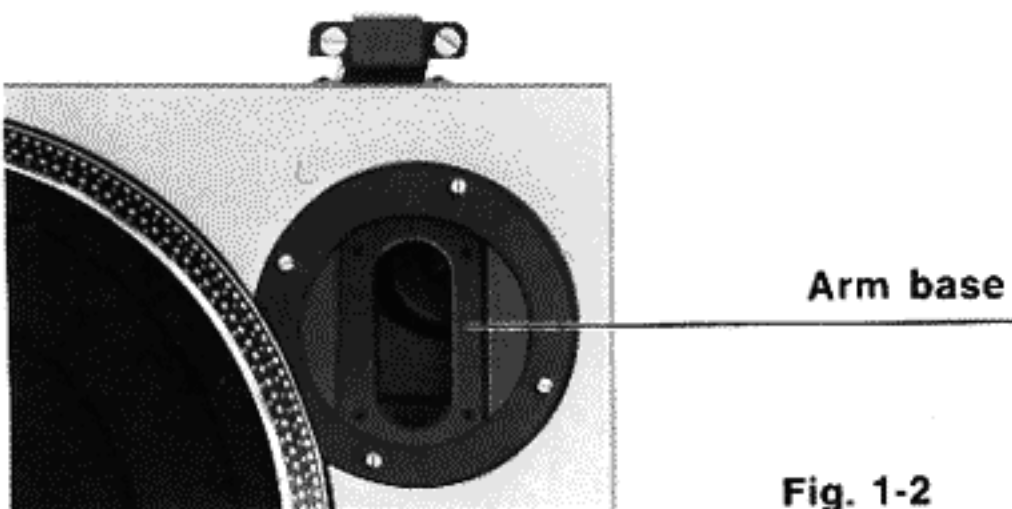

Fig. 1-1

The SL-150 is specially designed for SME improved tonearm or others. So install a tonearm according to the instructions of your tonearm.

### MODEL SL-150



Arm base

Fig. 1-2

### MODEL SL-150

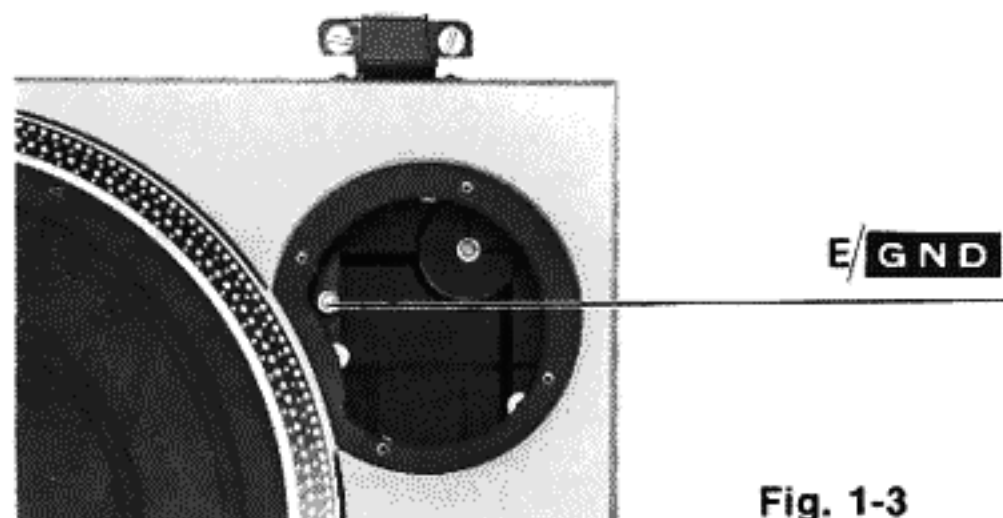

E/GND

Fig. 1-3

## 2 BEFORE USE

### 1 CHECK THE PARTS (SL-1500)

Player unit	.....1
Dust cover	.....1
Turntable platter	.....1
Turntable mat	.....1
45 r.p.m. adaptor	.....1
Special oil	.....1
Balance weight	.....1
Head shell	.....1
Overhang gauge	.....1

### (SL-150)

Player unit	.....1
Dust cover	.....1
Turntable platter	.....1
Turntable mat	.....1
45 r.p.m. adaptor	.....1
Special oil	.....1
Arm base	.....1

### 2 REMOVE THE SHIPPING SCREWS

Remove the two shipping screws and place them in the retaining holes for future use, when the player must again be transported. (See Figs. 2 and 3)

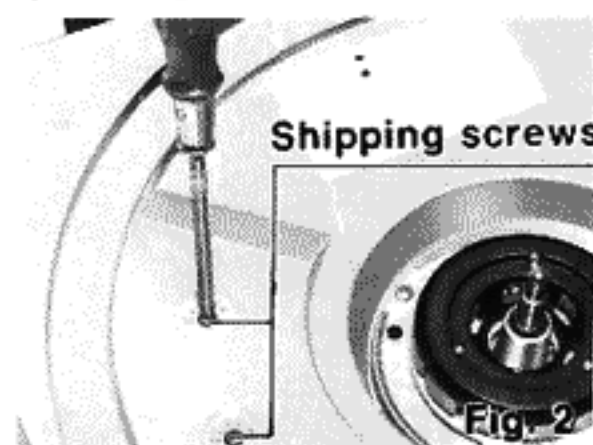

Shipping screws

Fig. 2

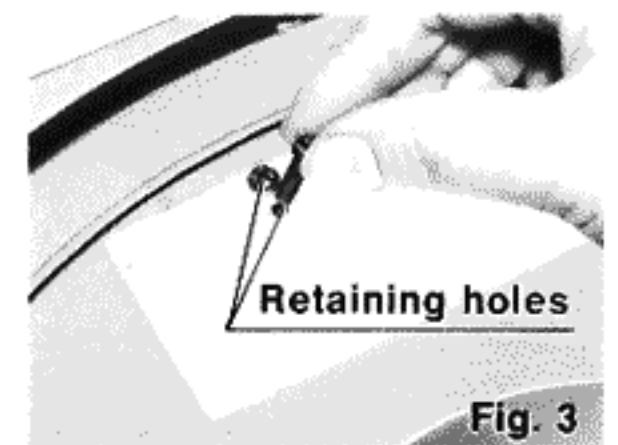

Retaining holes

Fig. 3

### ③ APPLY TWO OR THREE DROPS OF OIL TO THE MOTOR SHAFT

Although the unit has been lubricated before shipping from the factory, apply a few drops of oil to the motor shaft for assurance. After that, application of two or three drops of oil once every 2000 hours' operation or so is sufficient. The time interval is much longer than that of the former type motors (200-500 hours), so do not apply too much oil, nor more frequently than necessary. Never use any other type of oil.

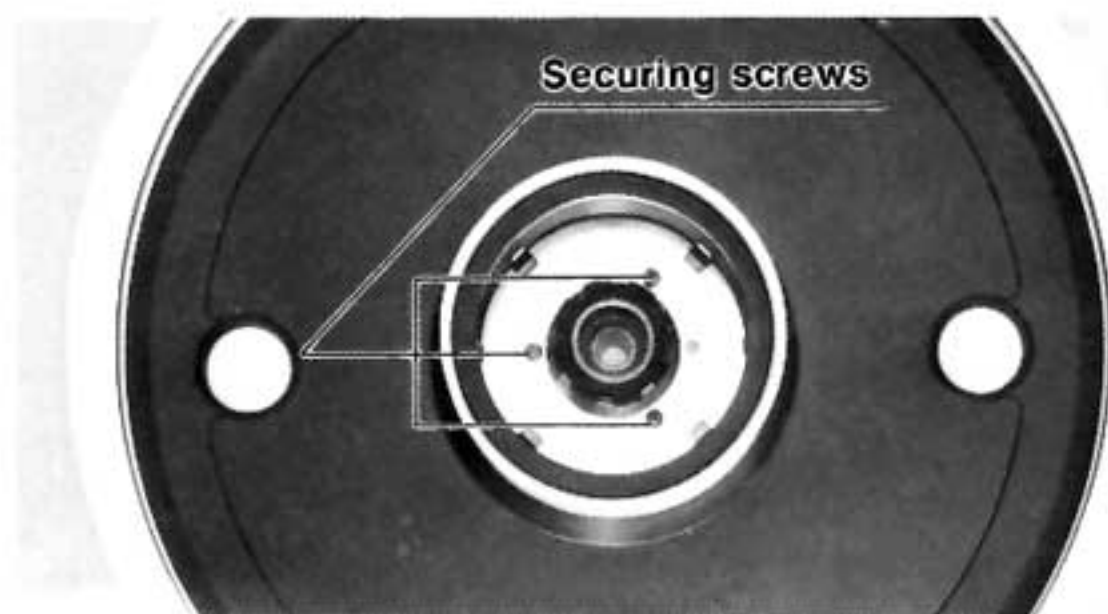

Fig. 5

#### NOTE

The rotor is connected to the reverse surface of the turntable platter. (The magnet of the motor is attached to the turntable platter.) To maintain optimum performance as specified, extra care should be taken to prevent adhesion of dust or iron filings to the magnet and not to damage the magnet by dropping it.

Do not remove the three screws securing the magnet. (See Fig. 5)

Should the position of the fixed magnet be altered by loosening the securing screws, the rated performance of the unit can not be guaranteed.

#### Caution:

Never connect the AC power plug before the assembly has been completed.

Attach the dust cover at the last stage of the assembly so that assembling of other parts and adjustments can be made efficiently.

## 3 HOW TO ASSEMBLE

### ① INSTALLATION OF THE TURNTABLE PLATTER

Place the turntable platter on the motor shaft.  
Place the rubber turntable mat on the platter.

### ② INSTALLATION OF THE CARTRIDGE (OPTIONAL)

Connect the lead wires to the cartridge terminals.

White (L +) .....Left channel +

Blue (L -).....Left channel -

Red (R +) .....Right channel +

Green (R -) .....Right channel -

Install the cartridge to the spacer, and tighten it with screws provided with the cartridge. (See Fig. 6)

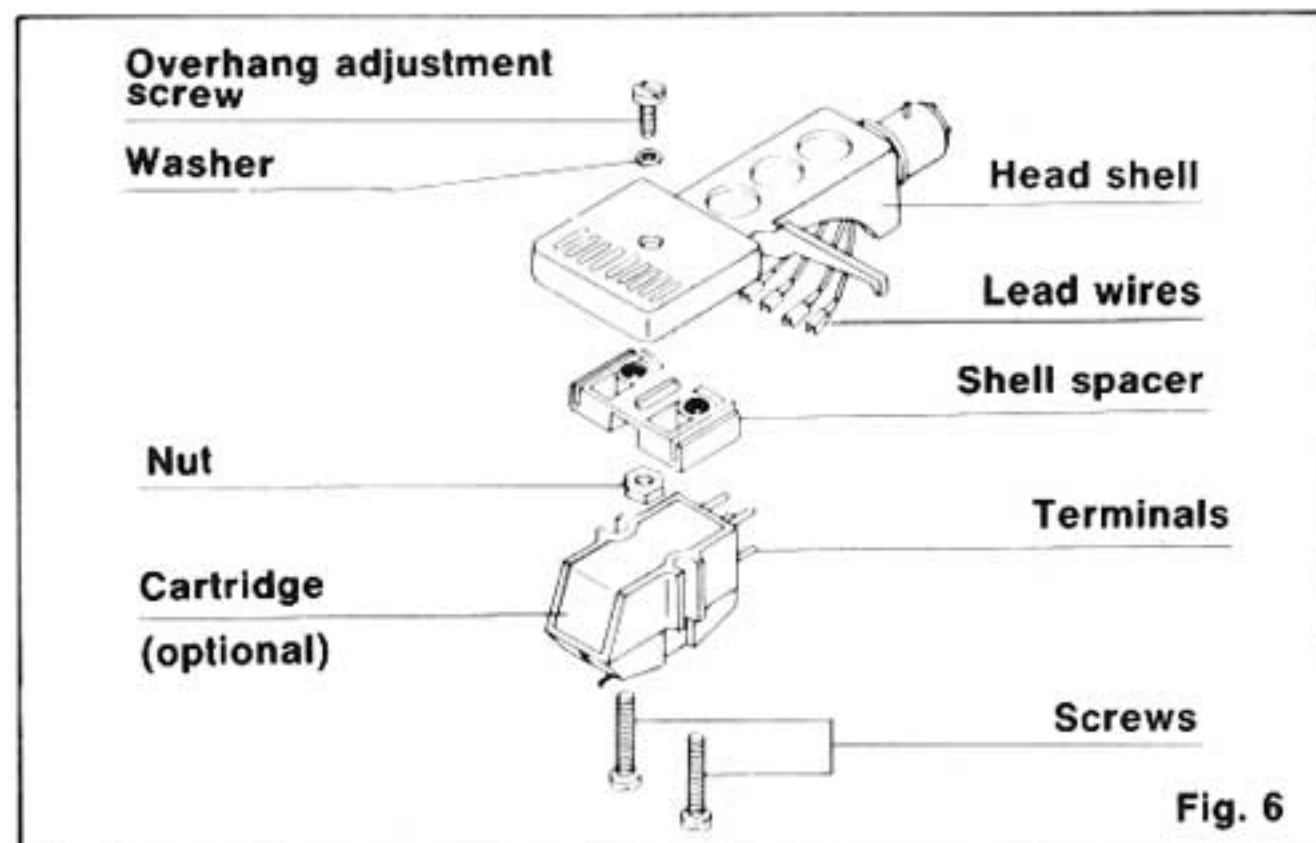

Fig. 6

Insert the head shell into the gauge. (See Fig. 7)

Loosen overhang adjustment screw and move the cartridge forward or backward until the stylus tip lines up with the edge of the gauge.

Tighten adjustment screw without moving the cartridge.

#### NOTE

Your cartridge is now adjusted for lowest tracking error and minimum distortion.

This gauge is exclusively designed for this tonearm.

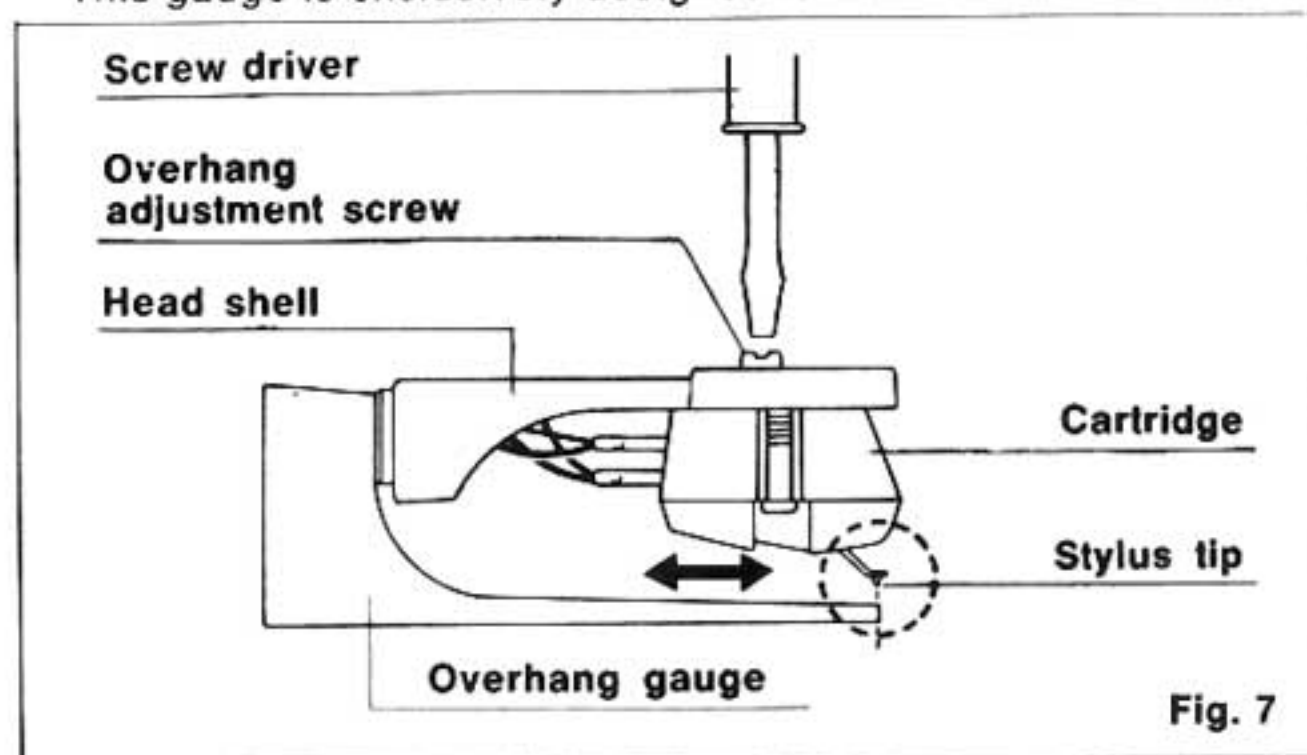

Fig. 7

### ③ INSTALLATION OF THE HEAD SHELL

Insert the head shell in the end of the tubular arm, and tighten it by turning the locking nut. (See Fig. 8)

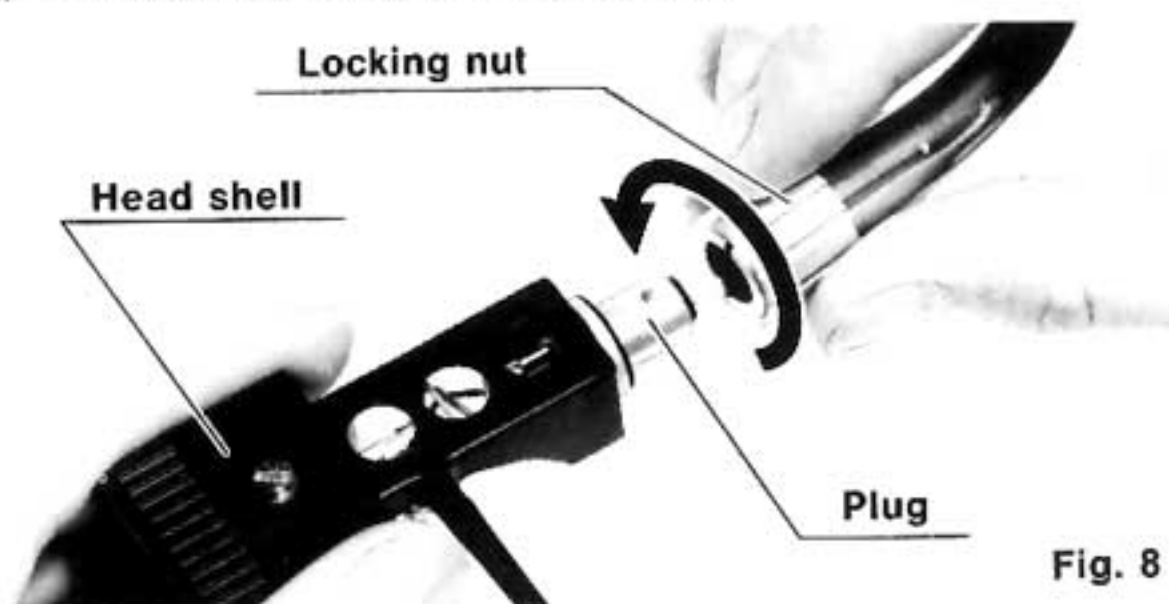

Fig. 8

### ④ ADJUSTMENT OF THE HORIZONTAL "0" BALANCE

Insert the balance weight on the rear shaft of the tonearm, with the numbers facing the front of the player.

Lower the cueing lever.

Release the arm clamp, and turn the entire balance weight forward or backward until the tonearm is approximately balanced (floats freely). In this condition, stylus pressure is "0". (See Fig. 9)

After the arm is horizontally balanced, gently rotate the stylus pressure ring, so that the "0" lines up with the center line of the rear shaft. (See Fig. 10)

Do not move the balance weight during this adjustment.

#### NOTE

Before adjustment of the "0" balance, make sure the anti-skating knob is set at the "0" position. (See Fig. 10)

If you turn the balance weight, the stylus pressure ring also moves in the same direction.

## HORIZONTALLY BALANCED STATE

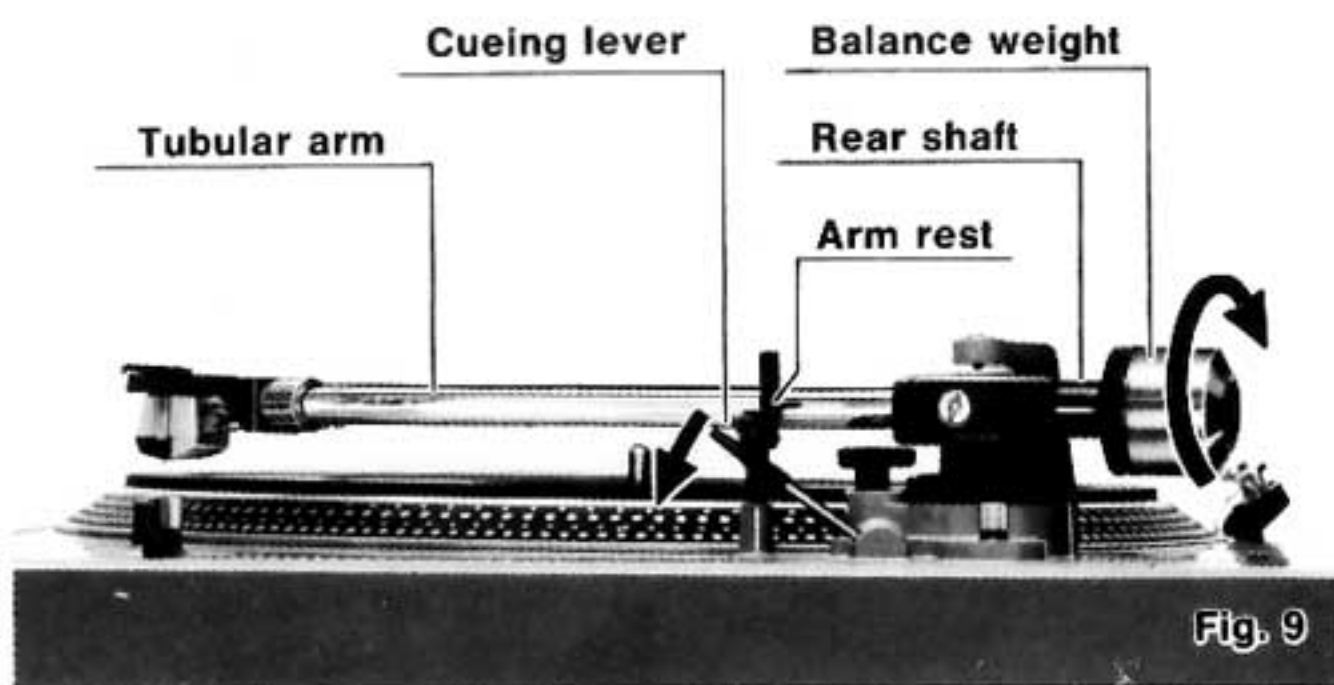

Fig. 9



Fig. 10

### 5 ADD THE STYLUS PRESSURE AND THE ANTI-SKATING FORCE VALUE

Turn the balance weight in the direction of the arrow (See Fig. 9) to the correct stylus pressure. (Follow the Cartridge Manufacturer's recommendation.)

Then turn the anti-skating knob to the same value as the stylus pressure ring. (See Fig. 11)



Fig. 11

### 6 INSTALLATION OF THE DUST COVER

Loosen the hinge screws and install the dust cover between the screws and hinges.

Retighten the screws securely. (See Fig. 12)

#### NOTE

In rare cases the dust cover may become the cause of "HOWLING" from speaker vibrations. In such a case we recommend that you remove the dust cover during playing.

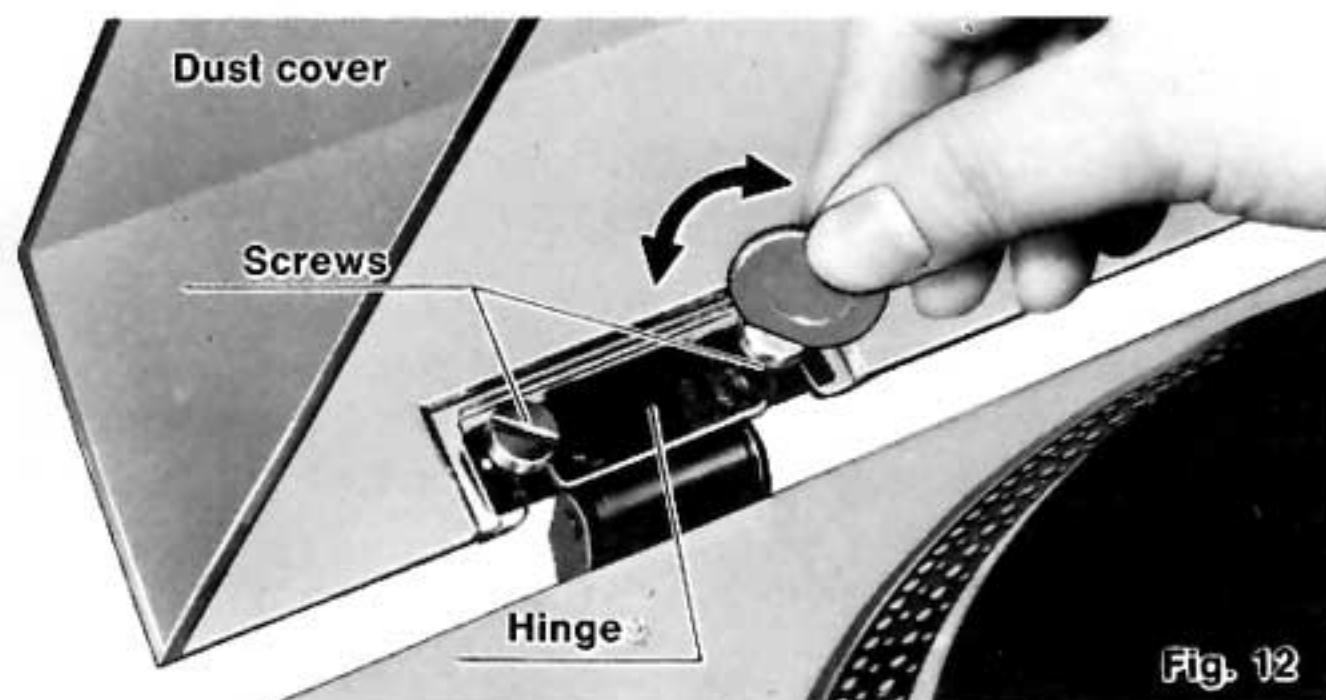

Fig. 12

## 4 PLACEMENT

- 1 Use the player in a stable and horizontal position, where there is little or no vibration.

- 2 Use the player as far away from the speakers as possible and isolate the player from sound radiation from them. This player is equipped with audio insulators to minimize acoustic feedback, but, if the speakers are placed too near the player, sound vibration may be transmitted to the tonearm and result in "HOWLING" feedback.
- 3 Do not place the player where it is exposed to direct sun, dust or moisture or heat. Also keep it away from heating equipment.

## 5 CONNECTIONS

### 1 CONNECT THE AC POWER PLUG

Connect the AC power plug to the AC wall socket.

#### CAUTION

Make sure that the AC line voltage corresponds to the turntable's requirements before connecting the power plug. Never connect to a DC power socket.

### 2 CONNECT THE OUTPUT TERMINALS

Connect the output terminals to the corresponding channels of your amplifier.

OUTPUT TERMINALS	AMPLIFIER
L (White)	→ L Channel
R (Red)	→ R Channel
E (Spade Lug)	→ GND

#### NOTE

Be sure to connect the ground wire to the amplifier ground terminal or to the chassis.

If this connection is not made properly, "HUM" will result.

## 6 HOW TO PLAY

- 1 Set the speed/power knob to the record speed corresponding to the record which you want to play. (See Fig. 13)

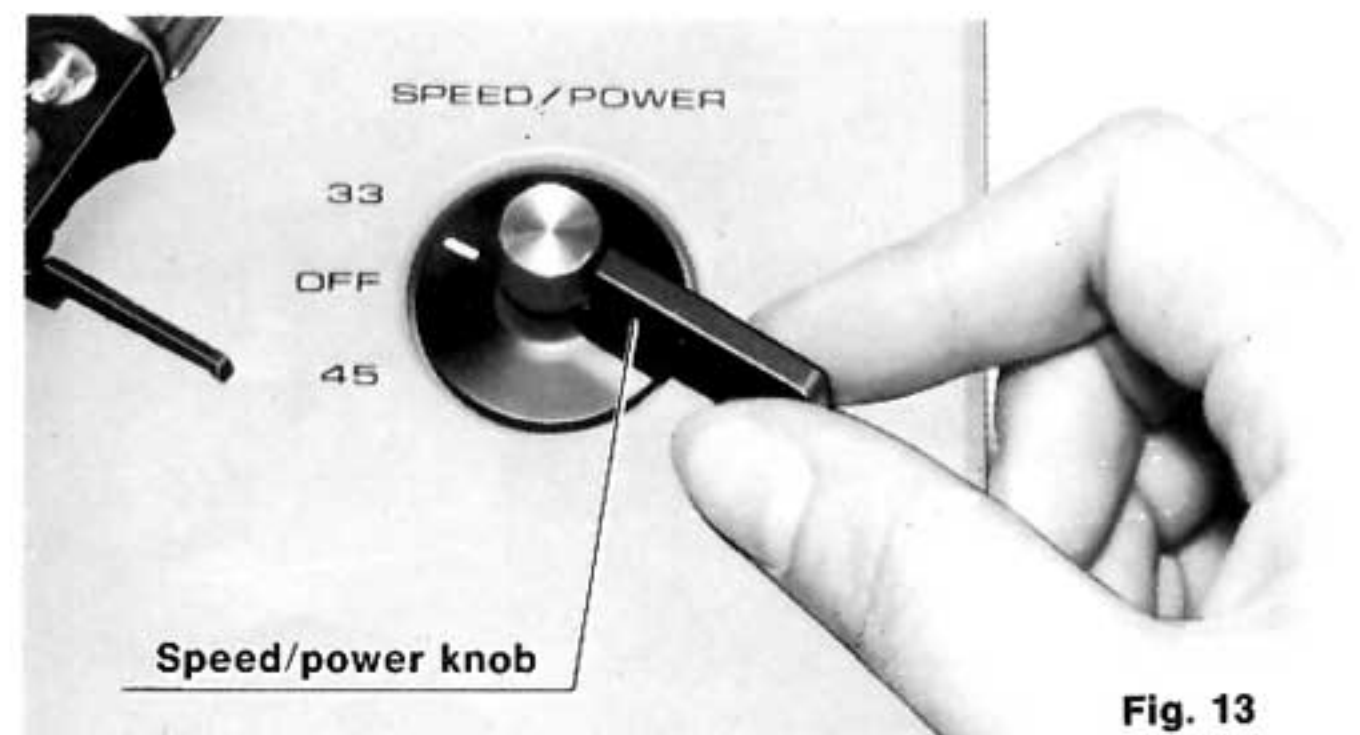

Fig. 13

- 2 Release the arm clamp and lift the cueing lever. (See Figs. 14 and 15)

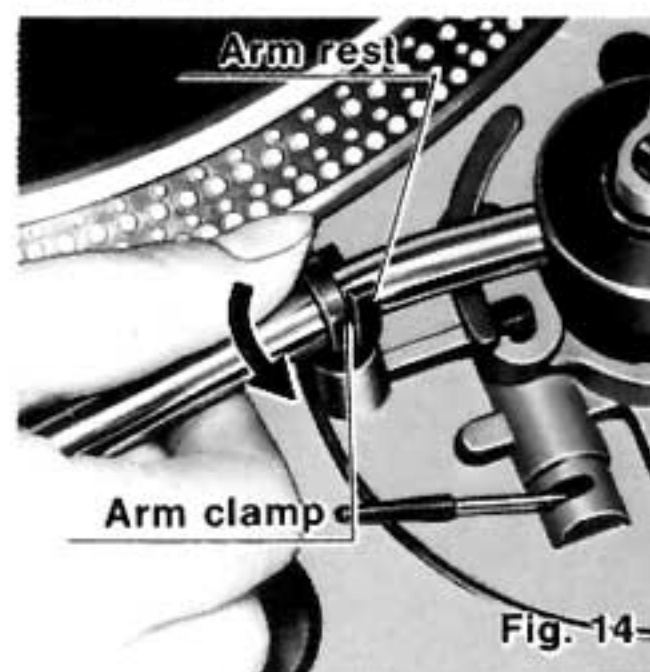

Fig. 14

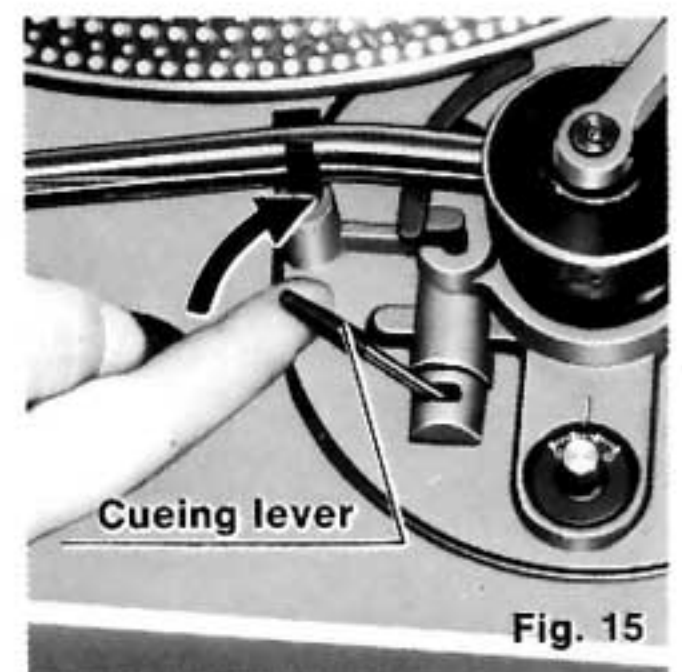

Fig. 15

- 3 Place the tonearm over the lead-in groove (or over any other desired groove), and then lower the cueing lever. The tonearm will descend slowly on the record and play will begin.
- 4 When play has finished, raise the cueing lever and place the tonearm on the arm rest, then secure it with the arm clamp.

#### NOTE

If you play a 45 r.p.m. record with a large center hole, use the 45 r.p.m. adaptor, supplied with this unit.

## 7 ADJUSTMENT

### ① SPEED ADJUSTMENT (with pitch control knobs) (See Fig. 16)

The speed is already adjusted accurately in the factory.

If, for any reason, you wish to readjust the speed, turn these pitch control knobs to "+" direction or "-" direction.

**"+" direction** ..... This increases the speed of the turntable platter.

Turn the knob to "+" direction if the strobe dots seem to be "falling back"; i.e., seem to be moving counterclockwise.

When the strobe dots appear to be stationary, the speed is accurate.

**"-" direction** ..... This decreases the speed of the turntable platter.

Turn the knob to "-" direction if the strobe dots seem to be "running ahead"; i.e., seem to be moving clockwise, until they appear stationary.

Each of the two turntable speeds (33-1/3 and 45 r.p.m.) can be adjusted within a range of 10%.

#### NOTE

Any change in powerline frequency will cause a change of the fluctuation rate of the neon or fluorescent lamp used for the illumination of the strobe dots. In such case the strobe dots will start to move very slightly.

Under normal conditions the powerline frequency from Electric Utility Companies is extremely stable. Under certain abnormal conditions, however, changes in line frequencies have been observed, averaging to about 0.2% when measured over a period of time.

Such change in line frequency will in no way affect the quality of the sound reproduction, as a change of line frequency does not change the rotational speed of the turntable.

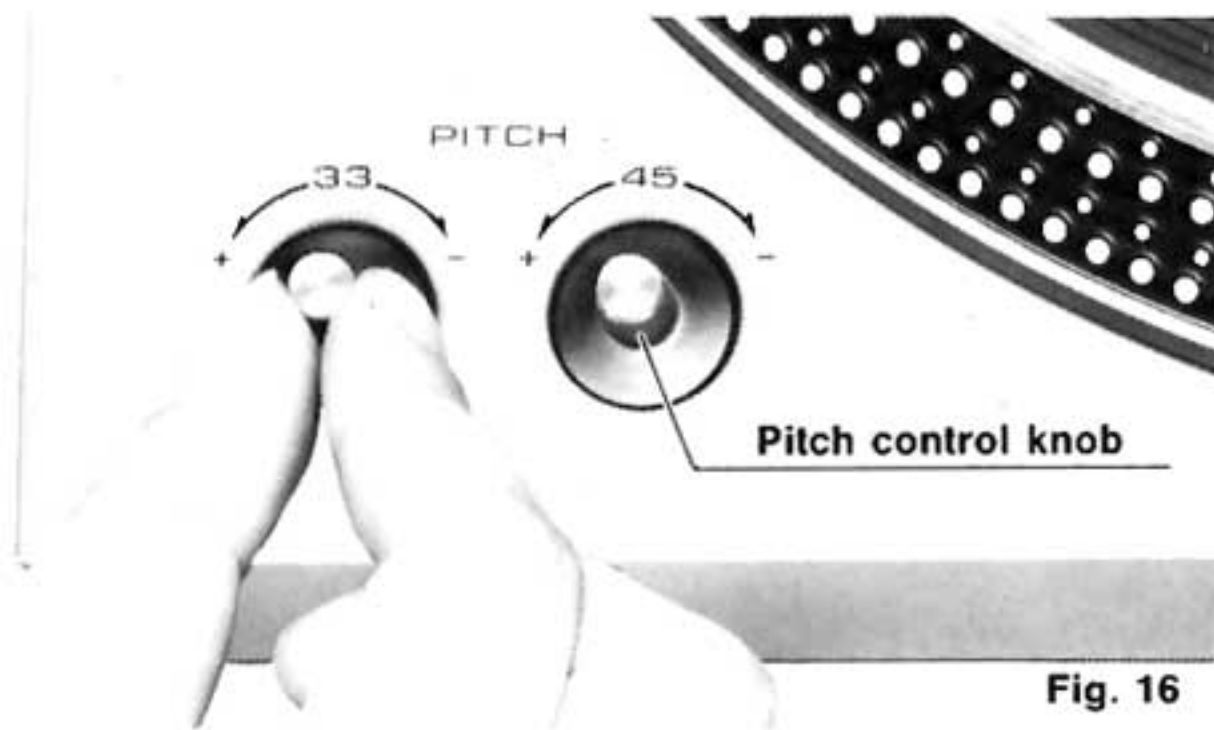

Fig. 16

### ② SPEED ADJUSTMENT (with speed adjustment screws) (See Fig. 17)

If, the adjustment cannot be properly made with the pitch control knobs, turn these screws clockwise or counterclockwise with a screw driver.

**Clockwise** ..... The rotation of the turntable platter will be slowed down.

**Counterclockwise** ..... The rotation will be speeded up.

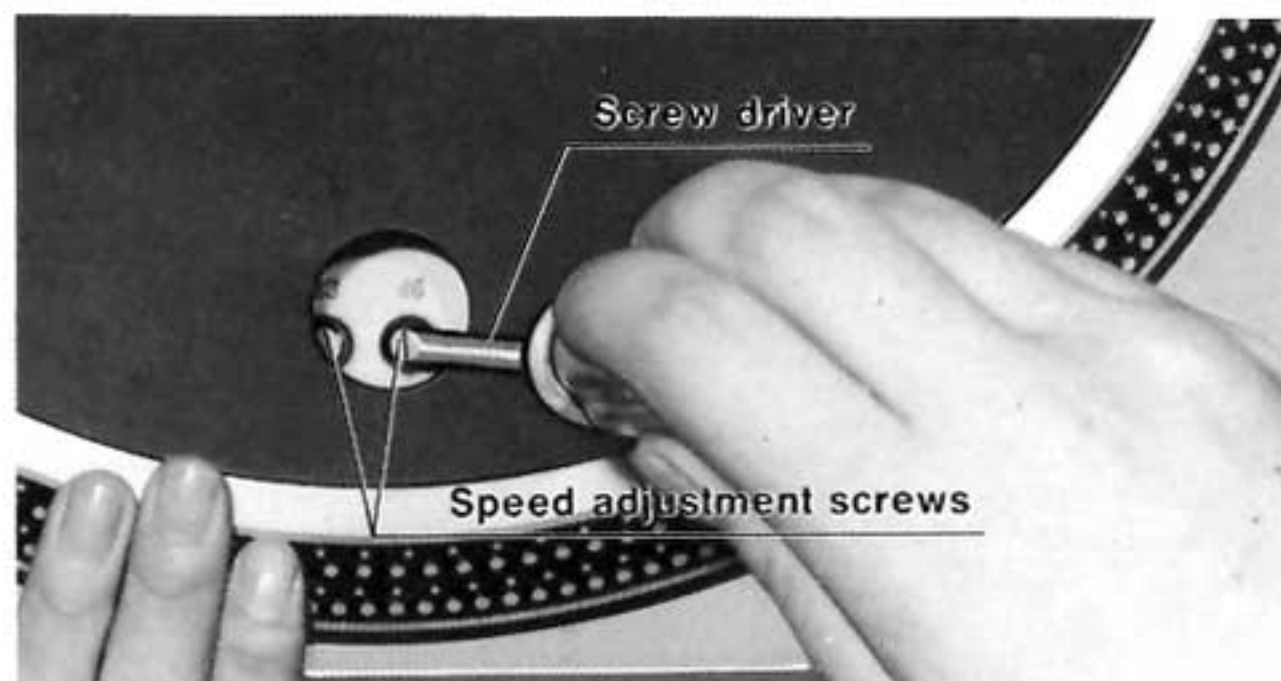

Fig. 17

### ③ ADJUSTMENT OF THE ARM LIFT HEIGHT

The arm lift height (distance between the stylus tip and record surface when cueing lever is raised) has been adjusted at the factory before shipping to approximately 5 to 10 mm (3/16" to 25/64").

If the clearance becomes too narrow or too wide because of the physical size of the different cartridges on the market turn the adjustment screw clockwise or counterclockwise, at the same time pushing the arm lift down.

#### Clockwise rotation

—distance between the record and stylus tip is reduced.

#### Counterclockwise rotation

—distance between the record and stylus tip increases.

#### NOTE:

As the adjusting screw has a hexagon head, be sure to make the adjustment while depressing the arm lift.

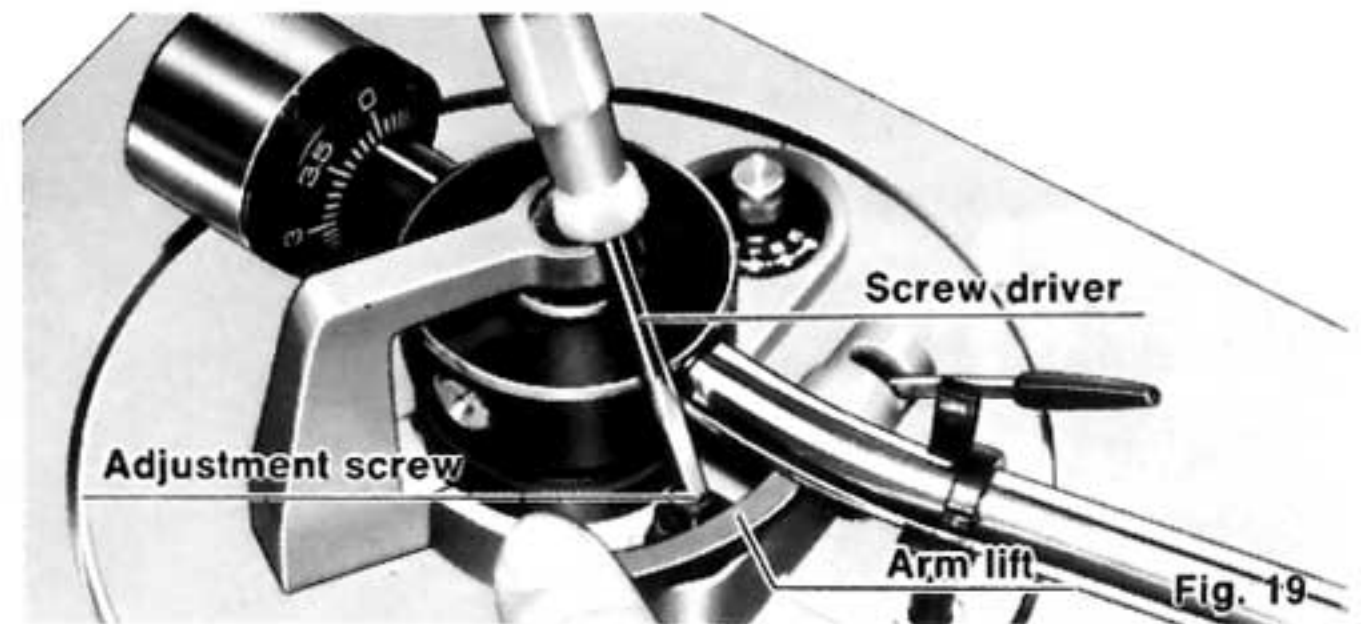
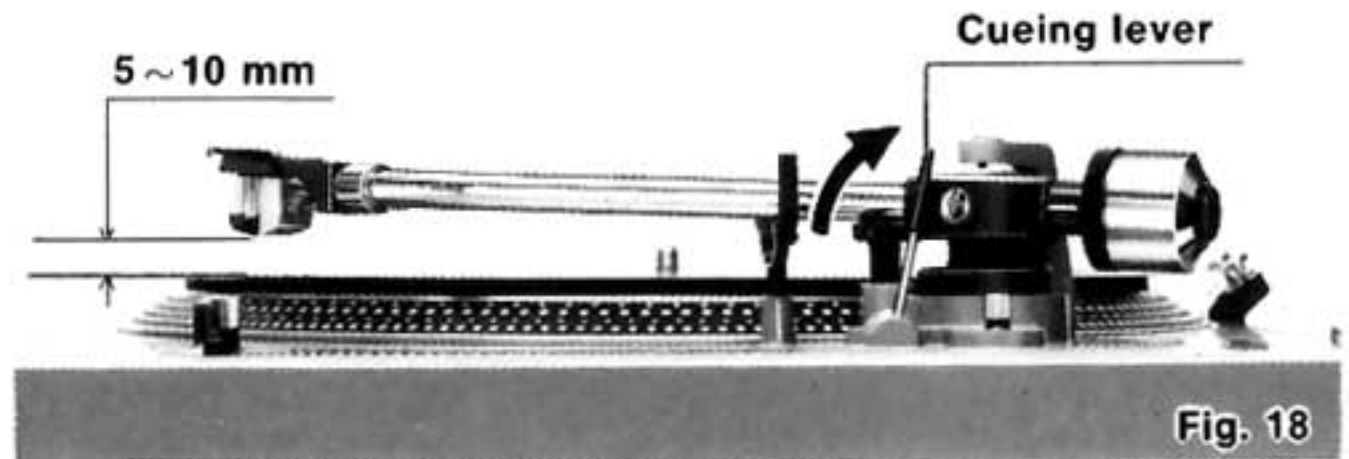

## 8 NOTES

### ① Extra care should be taken in handling the turntable platter.

The turntable platter has a rotor (the magnet of the motor) directly connected to it. Therefore, the turntable platter should not be removed from the motor shaft unnecessarily, since adhesion of dust or iron filings onto the magnet results in deterioration of the performance. Should it become necessary to remove the turntable platter, be sure to pull the AC power plug out of the socket.

### ② Wipe the dust cover and player case with a soft, dry cloth.

Never use any cleaners containing alcohol, benzine or thinner. Use of a chemical dust cloth and the like should also be avoided. Be sure that the dust cover is not exposed to insecticide spray, as cracks or blurs may result.

To remove stubborn finger prints or grease spots detach the dust cover or disconnect the AC power plug and use a soft cloth damped with a mild soap and water solution.

### ③ Dust and dirt adhering to the stylus tip or the record should be carefully removed.

If used with dust and dirt adhering to the stylus tip, the stylus will not fit into the sound groove of the record correctly. This may not only result in the deterioration of tone quality, but cause undue wear of the record and the stylus tip itself.

Use a brush having soft tips, moving it from the base to the tip of the stylus carefully for removing dust and dirt.

The record should also be carefully wiped with a record cleaner of high quality.

### ④ Before detaching or attaching the head shell, be sure to turn the volume control for the amplifier or receiver to "0" position, or to turn off the power.

Detaching or attaching of the head shell, with the volume control turned high, may not only result in unpleasant noises, but cause damage to the speakers.

## 9 SPECIFICATIONS

### (TURNTABLE SECTION)

Type	Manual Player system
Drive method	Direct drive
Motor	Ultra-low-speed brushless DC motor
Turntable platter	Aluminum die-cast, 33 cm (13") diameter
Turntable speeds	33-1/3 and 45 r.p.m.
Speed change method	Electronic
Variable pitch controls	Individual control knobs, 10% adjustment range
Wow and flutter	0.03% W.R.M.S. (JIS C5521) ±0.042% Weighted zero to peak (DIN 45507)
Rumble	-50 dB (DIN 45539A) -70 dB (DIN 45539B)

### (GENERAL)

Power supply	~110/120/220/240 V, 50 or 60 Hz
Power consumption	6 W
Dimensions	13.9 × 45.3 × 36.6 cm (H × W × D) 5-1/2 × 17-3/4 × 14-3/8 inches
Weight	7.8 kg (17.2 lb)

### (TONEARM SECTION)

Type	Universal "S" shaped tubular arm, static-balanced type, direct reading stylus pressure adjustment, with anti-skating force control device, and cueing device
Effective length	230 mm (9-1/16")
Overhang	15 mm (19/32")
Friction	7 mg (horizontally and vertically)
Effective mass	23 g (6.5 g cartridge weight 1.5 g stylus pressure)
Tracking error angle	Within +3° (at the point of 145 mm (5-45/64") from the center) Within +1° (at the point of 55 mm (2-3/16") from the center)
Adjustable stylus pressure	0 to 3 g
Cartridge weight range	5 to 11 g
Head shell weight	9.5 g

## 10 FEATURES

### (TURNTABLE SECTION)

Motor construction peculiar to Technics in which the rotor of the motor is integrally connected to the turntable platter. In Technics player system we took the lead in the world by putting the Direct Drive system on the market with a marked improvement in the performance of record players. Since then, we have developed numerous players of high performance, furnishing new topics of conversation each time. One of these achievements is the motor construction of this unit, unique and singular in the world, in which the rotor of the motor is directly connected to the turntable platter. Moreover, the motor base has been integrally connected to the player case of diecast aluminum for presenting player systems of higher accuracy and rational construction.

### Hi-Fi performance with rumble (signal to noise ratio) of -70 dB (DIN 45539B) and wow and flutter of 0.03% (W.R.M.S.)

The brushless DC motor of ultra-low speed (same rotation as the record) adopted has extremely small power consumption of 0.1 W, which is less than approximately 1/100 when compared with the AC motor (10-20 W). Thus the DC motor is free from vibrations due to excessive energy or heat generation. Needless to say, it has no reduction transmission mechanism such as a belt or idler, which may give rise to uneven rotation.

### Player case is of diecast aluminum for a slim & compact design

### (TONEARM SECTION)

Highly sensitive universal tonearm which fully realizes the excellent performance of high-compliance cartridges

### A superior combination of the precision pivot bearing and gimbal suspension system

The employment of the precision pivot bearings at the horizontal and vertical journals of the tonearm, coupled with the gimbal suspension system, displays an excellent tracing performance in cooperation with the use of high-compliance cartridge.

### Diecast aluminum head shell

The head shell, integrally formed by strong diecast aluminum for reduction in weight, is protected from harmful head shell resonance. Additionally, the head shell terminals are gold-plated for prevention of contact faults at replacement.

### Viscous damped cueing

To prevent damage to the stylus tip and records liable to take place during operation of the tonearm, a cueing device damped with viscous oil is adopted.

Since the tonearm can be raised or lowered through operation of the lever, location of a desired playing portion or temporary suspension of the playing are conveniently achieved.

### Anti-skating control

Proper outside force can be applied by such a simple operation as aligning the knob with the same value as the stylus pressure, thus cancelling the skating force harmful to the stylus tip.

### Low-capacitance phono cables that will not impair the high frequency characteristics of the cartridge

### Uniquely designed overhang gauge

This unique accessory is designed not only as an overhang adjustment gauge, but also as a head shell stand.

**Matsushita Electric Trading Co., Ltd.**

P.O. Box 288, Central Osaka Japan