

STROBE FLASHER FOR NIGHT CYCLING SAFETY

# Popular Electronics

WORLD'S LARGEST-SELLING ELECTRONICS MAGAZINE

OCTOBER 1976/\$1

## FOR TAPE RECORDISTS

Low-Cost Panning/Mixer Project  
What's New In Tape Recorders

## FOR HOBBYIST WORKBENCHES

Build an Electrolytic  
Capacitance Meter  
Tools for Electronics  
Experimenters

## AUTO ELECTRONICS PROJECTS

## TEST REPORTS

ADC "Digital Control"  
Turntable  
Micro-Acoustics  
Stereo Cartridge  
Phase Linear  
Stereo Power Amp  
Pace AM/VHF  
Weather Mobile CB  
Processor Technology  
Video Display

Check  
Engine  
Performance  
While  
You Drive



Compact  
LED  
Digital Clock

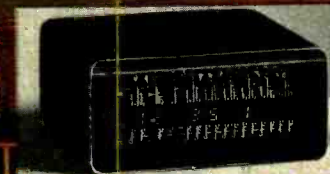

490604 LNE 10082099 0410 JAN79  
KENNETH J. JONES  
1088 22ND A / SE  
MINNEAPOLIS MN 55414

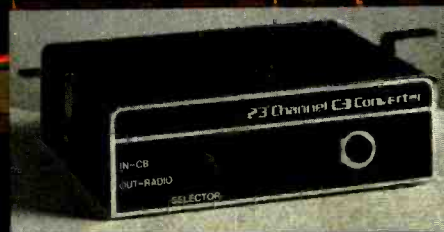

\$14 CB  
Converter  
Kit

**Experience is the best teacher.** You might settle for any CB first time around. Understandably. A lot of people think they're all pretty much alike. But you'll soon discover that, like everything else, there are exceptions.

**Ask the pros.** America's long distance truckers. These guys talk CB day in and day out. And they demand the best. That's why truckers refer to the Cobra 29 as "The Diesel Mobile."

**Listen to Cobra.** You'll hear a big difference. Because the Cobra 29 gives you features which assure crystal clear reception. Like switchable noise limiting and blanking, to cut out practically all pulse and ignition interference. Add squelch control and RF gain and you've got exceptional—adjustable—receiver clarity. Even in the heaviest CB traffic. You also get Delta Tuning which makes up for the other guy, because even off-frequency transmitters are pulled in. Perfectly.

**Talk to Cobra.** And you know you're punching through. One glance at the

29's over-sized illuminated meter tells you just how much power you're punching out and pulling in. For voice modulation the DynaMike delivers at 100%. Same way with power: The 29 transmits at maximum power levels.

**Sooner or later you'll get a Cobra.** And you'll get engineering and craftsmanship second to none. Performance that will make your first CB seem obsolete. Reliability and durability that have set standards for the industry. Above all, you'll get power. The power to punch through loud and clear like nothing else. Because when it comes to CB radio, nothing punches through loud and clear like a Cobra.



**Punches through loud and clear.**

Cobra Communications Products  
**DYNASCAN CORPORATION**  
6460 W. Cortland St., Chicago, Illinois 60635

CIRCLE NO. 14 ON FREE INFORMATION CARD

# IF YOUR FIRST CB ISN'T A COBRA YOUR SECOND ONE WILL BE.



Whether you're a  
seasoned practitioner  
or a striving beginner...

Here are the  
fundamentals.



Software Design  
for Microprocessors.  
378 pages  
only \$12.95.\*

Basic Electricity and DC  
Circuits. 1,016 pages  
only \$19.95.\*

Both of these new books get down to basics—present clear, readable discussions. Loaded with examples, references, graphs, tables. Also, data sheets, bibliography and appendices. You're *encouraged* to learn—and apply your knowledge to practical situations.

**Software Design for Microprocessors.** Helps you understand the hardware/software relationship of microprocessors. A convenient, stand-alone text, suitable for both first-time users of microprocessors and the technically advanced.

Beginning chapters deal with basic terms, basic machine architecture, instructions and addressing. Successive chapters treat the process of generating software, defining required support and documentation, and designing a simple machine to program a problem. Sample problems at the conclusion allow you to apply your new knowledge.

**Basic Electricity and DC Circuits.**

A self-teaching course designed to enable you to predict and control the behavior of most basic and complex DC circuits. Each lesson begins with a listing of objectives—what new skills and knowledge you should have upon successful completion. The text within each chapter is arranged so that you progress at your own pace, with answers to commonly asked questions presented at key points.

Examples show you how to use the principles of basic DC electricity as

they are taught. You'll analyze basic DC circuit schematics and find yourself experimenting with your own designs. Plus, a quiz included at the end of each lesson allows you to gauge your progress.

If you're a hobbyist, student, or simply interested in broadening your knowledge of electronics, these books are *must* additions to your library. Use the coupon below to order your copies today.



**Texas Instruments Learning Center.**

Mail checks and money orders to: P. O. Box 3640, M/S 84, Dallas, Texas 75285. Postage paid. Add state and local taxes where applicable. †

Mail company purchase orders to: P. O. Box 5012, M/S 84, Dallas, Texas 75222. Postage and taxes will be added to your invoice.

Please send me \_\_\_\_\_ copies of (LCB 1891) Software Design for Microprocessors at \$12.95\* per copy. \_\_\_\_\_ copies of Basic Electricity and DC Circuits at \$19.95\* per copy.

I enclose  check  money order for \$ \_\_\_\_\_

Name \_\_\_\_\_

Address \_\_\_\_\_

City \_\_\_\_\_ State \_\_\_\_\_ Zip \_\_\_\_\_

†All states except: AK, DE, HI, MF, NH, OR.

\*Suggested retail price; subject to change without notice.  
© 1976 Texas Instruments Incorporated

**TEXAS INSTRUMENTS**  
INCORPORATED

To SBE

# in·no·va·tion

*is not just another word*

In fact, "innovation" is *the* word that guides SBE engineers in their quest for better ways to improve personal communications equipment.

An example of SBE innovation at its imaginative best is OPTI/SCAN. This compact 10-channel scanning monitor requires no crystals but is capable of scanning over 16,000 radio frequencies between 30 MHz and 510 MHz.

The secret of such electronic wizardry lies in the unique use of digital frequency synthesis, combined with an exclusive optical scanner and program card system. The "memory" for specific frequencies to be monitored is programmed in 10-frequency groups on a small plastic card no larger than a credit card. Frequency bands can be mixed on the same card; and frequency groups to be scanned can be changed instantly simply by replacing one pre-programmed card with another.

SBE innovation has transformed the scanning monitor from a fixed, inflexible unit of limited range and scope into an infinitely versatile electronic marvel that puts a limitless range of frequencies at your fingertips, wherever you are, wherever you may travel.

The same innovative skill and imagination that goes into OPTI/SCAN is reflected in the full SBE line of communications equipment: citizens band, land mobile, marine and special application.

Discover how *you* can benefit from SBE's electronic innovations.



**Better Communications through Creative Technology**

For information write: SBE, Inc., 220 Airport Blvd., Watsonville, CA 95076

INTERNATIONAL OFFICES: E. S. Gould Marketing Co. Ltd., Quebec, Canada/Linear Systems S.A. Geneva 1, Switzerland

CIRCLE NO. 58 ON FREE INFORMATION CARD

[www.americanradiohistory.com](http://www.americanradiohistory.com)

# Popular Electronics®

WORLD'S LARGEST SELLING ELECTRONICS MAGAZINE

## FEATURE ARTICLES

**WHAT'S NEW IN TAPE RECORDERS?** ..... Leonard Feldman 45  
*An overview of the latest in tape decks and formats.*

**TOOLS FOR ELECTRONICS EXPERIMENTERS** ..... A. A. Mangieri 55  
*Today's projects require some special tools and techniques.*

**FIND THE HIDDEN ELECTRONICS WORDS** ..... Thomas R. Sear 71

## CONSTRUCTION ARTICLES

**A CAR IGNITION MONITOR** ..... Walter B. Henry 37  
*Visual indication of timing angle, rpm, dwell, and dc voltage.*

**A LED DIGITAL CLOCK FOR VEHICLES** ..... William Green 41

**THE "ROADMATE" CB CONVERTER** ..... Dean Todd 43  
*Allows you to listen to all 23 CB channels on any AM radio.*

**BUILD PANAMIX** ..... James Barbarello 50  
*Low-cost, 5-input stereo/mono audio mixer.*

**BUILD THIS LOW-COST CAPACITANCE METER** ..... Thomas McGahee 64

**A STROBE FLASHER FOR NIGHT CYCLING** ..... Matthew Fitchenbaum 68

## COLUMNS

**STEREO SCENE** ..... Ralph Hodges 30  
*Consumer Electronics Show—Summer 1976.*

**CB SCENE** ..... Ray Newhall 86  
*The Long and the Short of Antennas.*

**COMPUTER BITS** ..... Hal Chamberlain 88  
*Computer Music—Part II.*

**AMATEUR RADIO** ..... Herbert S. Brier 92  
*250 Watts for Novices.*

**INSIDE BASIC ELECTRONICS** ..... Sol D. Prensky 94  
*Capacitors and RC Circuits.*

**EXPERIMENTER'S CORNER** ..... Forrest M. Mims 107  
*High-voltage DC/DC Converters.*

## PRODUCT TEST REPORTS

**ADC ACCUTRAC 4000 RECORD PLAYER** ..... 72

**MICRO-ACOUSTICS MODEL 2002e PHONO CARTRIDGE** ..... 74

**PHASE LINEAR MODEL 200 BASIC POWER AMPLIFIER** ..... 76

**PACE MODEL 145 AM CB TRANSCEIVER** ..... 82

**PROCESSOR TECHNOLOGY MODEL VDM-1 VIDEO DISPLAY MODULE** ..... 84

## DEPARTMENTS

**EDITORIAL** ..... Art Salsberg 4  
*Solar Energy.*

**LETTERS** ..... 6

**OUT OF TUNE** ..... 8  
*"Learning Electronic Theory With Hand Calculators, Part One" (July 1976)*

**NEW PRODUCTS** ..... 10

**NEW LITERATURE** ..... 22

**NEWS HIGHLIGHTS** ..... 34

**OPERATION ASSIST** ..... 105

**ELECTRONICS LIBRARY** ..... 106

**ADVERTISERS INDEX** ..... 131

POPULAR ELECTRONICS, October 1976, Volume 10, Number 4, Published monthly at One Park Avenue, New York, NY 10016. One year subscription rate for U.S., \$9.98; U.S. Possessions and Canada, \$12.98; all other countries, \$14.98 (cash orders only, payable in U.S. currency). Second Class postage paid at New York, NY and at additional mailing offices. Authorized as second class mail by the Post Office Department, Ottawa, Canada and for payment of postage in cash.

POPULAR ELECTRONICS including ELECTRONICS WORLD, Trade Mark Registered. Indexed in the Reader's Guide to Periodical Literature.

COPYRIGHT © 1976 BY ZIFF-DAVIS PUBLISHING COMPANY. ALL RIGHTS RESERVED.

Ziff-Davis also publishes Boating, Car and Driver, Cycle, Flying, Modern Bride, Popular Photography, Skiing and Stereo Review.

Material in this publication may not be reproduced in any form without permission. Requests for permission should be directed to Jerry Schneider, Rights and Permissions, Ziff-Davis Publishing Co., One Park Ave., New York, NY 10016.

**Editorial correspondence:** POPULAR ELECTRONICS, 1 Park Ave., New York, NY 10016. Editorial contributions must be accompanied by return postage and will be handled with reasonable care; however, publisher assumes no responsibility for return or safety of manuscripts, art work, or models.

**Forms 3579 and all subscription correspondence:** POPULAR ELECTRONICS, Circulation Dept., P.O. Box 2774, Boulder, CO 80302. Please allow at least eight weeks for change of address. Include your old address, enclosing, if possible, an address label from a recent issue.

**EDGAR W. HOPPER**  
*Publisher*

**ARTHUR P. SALSBERG**  
*Editorial Director*

**LESLIE SOLOMON**  
*Technical Editor*

**JOHN R. RIGGS**  
*Managing Editor*

**STEPHEN B. GRAY**  
*Senior Editor*

**ALEXANDER W. BURAWA**  
*Feature Editor*

**EDWARD I. BUXBAUM**  
*Art Director*

**JOHN McVEIGH**  
*Associate Editor*

**ANDRE DUZANT**  
*Technical Illustrator*

**PATRICIA GIRRIER-BROWN**  
*Production Editor*

*Contributing Editors*  
**HAL CHAMBERLAIN, LOU GARNER**  
**GLENN MAUSER, JULIAN HIRSCH**  
**RALPH HODGES, ART MARGOLIS**  
**FORREST MIMS, RAY NEWHALL**  
**SOL PRENSKY, WILFRED SCHERER**

**JOSEPH E. HALLORAN**  
*Advertising Director*

**JOHN J. CORTON**  
*Advertising Sales*

**LINDA BLUM**  
*Advertising Service Manager*

**PEGI McENEANEY**  
*Executive Assistant*

**STANLEY NEUFELD**  
*Associate Publisher*

ZIFF-DAVIS PUBLISHING COMPANY  
Popular Electronics  
Editorial and Executive Offices  
One Park Avenue New York, New York 10016  
212-725-3500  
Hershel B. Sarbin, President  
Furman Hebb, Executive Vice President  
John R. Emery, Senior Vice President, Finance and  
Treasurer  
Phillip T. Heffernan, Senior Vice President, Marketing  
Edward D. Muhlfeld, Senior Vice President, Sports Division  
Philip Sine, Senior Vice President  
Frank Pomerantz, Vice President, Creative Services  
Arthur W. Butzow, Vice President, Production  
Lawrence Sporn, Vice President, Circulation  
George Morrissey, Vice President  
Sydney H. Rogers, Vice President  
Sidney Holtz, Vice President  
Al Traina, Vice President  
Philip Korsant, Vice President  
Paul H. Chook, Vice President, Market Planning  
Charles B. Seton, Secretary  
Edgar W. Hopper, Vice President, Electronics Div.  
William Ziff, Chairman  
W. Bradford Briggs, Vice Chairman

Midwestern Office  
The Pattis Group, 4761 West Touhy Ave.,  
Lincolnwood, Illinois 60644, 312 679-1100  
GERALD E. WOLFE, THOMAS HOCKNEY  
Western Office  
9025 Wilshire Boulevard, Beverly Hills, CA 90211  
213 273-8050: BRadshaw 2-1161  
Western Advertising Manager, BUD DEAN

Japan: James Yagi  
Oji Palace Aoyama, 6-25, Minami Aoyama  
6 Chome, Minato-Ku, Tokyo 407-1930/6821,  
582-2851



The publisher has no knowledge of any proprietary rights which will be violated by the making or using of any items disclosed in this issue.



## Editorial

### SOLAR ENERGY

People continually ask me, "What do you think the next hot product will be?" Of late, I've answered, "solar energy devices," mischievously. When pressed, however, I'll readily admit that it won't really be the *next* exciting product for the public, but one day solar energy will surely have a significant impact on our lives.

Today, there are a few solar-powered homes, most of them experimental and, without mass-produced solar panels, certainly costly. But Edmund Scientific Company's catalog devotes three pages to energy-from-the-sun devices, so there's obviously a coterie of hobbyists already experimenting in this field. There's also a host of recent books published on solar energy (though nothing approaching the plethora of books on CB radio) as well as journals, newsletters and industry directories.

In truth, energy from the sun to heat homes and feed electric appliances is not destined to provide us with a very substantial part of our power needs in the near future. Estimates of solar power expected to be supplied in the U.S. are not at all awesome at this time. For example, projections by the Energy Research and Development Administration (ERDA) indicate only 0.07% of our energy consumption to be from solar means by 1985, 5% by the year 2000 and 15% by 2020. But though percentages are not great, it still adds up to a lot of power (almost 1½ electrical gigawatts in 1985).

Solar thermal system research is moving along, however, with about 31-million dollars budgeted for 1977 by ERDA (compared to almost 1.1-billion dollars for breeder nuclear reactor and fusion systems). But the greatest potential for making use of the sun's energy for electric power rests with satellite solar stations orbiting the earth. Materials launched from the earth can then be assembled at zero gravity to simplify the operation. More importantly, the sun is always shining beyond our atmosphere and it's a virtually unlimited energy source. The solar energy would be transmitted to earth by beaming microwave energy to a receiving station. (Klystron amplifying tubes won't be needed because space is a vacuum.)

Although the benefits of solar energy for obtaining massive amounts of electric power will not become apparent to many of us in our lifetime, low-power needs are today being met by this source. There are solar-powered wrist-watches in use and solar food-cooking apparatus. Automatic electric generators that get all their power from the sun are being produced for army units in Israel. So on a small scale, solar energy is being used right now; and it shows promise of having much wider applications even with present technology.

With silicon solar cells and panels widely available to experimenters at modest cost, we expect more and more POPULAR ELECTRONICS readers to develop solar power supplies for a variety of needs. We will publish plans for building an inexpensive, reasonably accurate solar meter in an upcoming issue. It will enable one to make quantitative measurements of solar energy.

*Art Salsberg*

From Dynascan Corporation

Good things  
DO come in small packages...



ACTUAL-SIZE PHOTO (5.24" x 7.25" x 11.2")

Model 1403A \$209

## B&K-PRECISION ANNOUNCES A NEW 5MHz 3" SCOPE

The B&K-PRECISION Model 1403A is a real example of taking a good idea and making it even better. We've redesigned our most popular 3" scope to bring you new features and higher performance but retained the same ultra-compact cabinet.

The new high-brightness 3" CRT produces sharp waveforms on a P31 blue phosphor. A smoked glass graticule helps increase image contrast for clear viewing in the brightest rooms. The 1403A is conservatively rated at a 5MHz bandwidth for 10mV/div. vertical sensitivity and will typically sync on signals at 8MHz. This rugged small scope has DC amplifiers on both vertical and horizontal axes and direct deflection terminals for waveform display up to 450MHz! Maximum input is 600Vp-p. Input impedance is 1 megohm for both vertical and horizontal inputs. A Z-axis is also provided.

Perhaps the most striking feature of the 1403A is its ultra-compact size, (HWD) 5.24 x 7.44 x 11.2".

This feature, combined with a sturdy integral handle, makes the 1403A ideal for field service applications. When bench or storage space is at a premium, you'll come to appreciate the convenient size even more.

We think the 1403A is the most cost-effective small scope available. Compare the specs, features, size and price, and we're sure that you'll agree. Available options include the LC-14 carrying case and PR-21 isolation/ direct probe.

For immediate delivery, contact your B&K-PRECISION distributor.

**B&K PRECISION**  
PRODUCTS OF DYNASCAN

6460 W. Cortland Avenue, Chicago, IL 60635 312/889-9087



# In a class by itself.

The Phase Linear 400 Power Amplifier has only one serious competitor when it comes to advanced design, superior performance, made-one-at-a-time craftsmanship, proven reliability, elegant appearance . . . and incomparable value. And that's the Phase Linear 700B. Hear them both at your dealer soon.

## Phase Linear 400

THE POWERFUL DIFFERENCE

201 watts per channel, min. RMS at 8 ohms from 20 Hz-20 kHz with no more than .25% total harmonic distortion.

PHASE LINEAR CORPORATION  
20121 - 48th Avenue S.W.  
Lynnwood, Washington 98036

CIRCLE NO. 50 ON FREE INFORMATION CARD

## Letters

### BUILDING THE COSMAC "ELF"

Congratulations on "Build the Cosmac 'Elf'" (August, p 33). It is refreshing to read about a project that involves an MPU other than the 8080 or 6800.—W. J. Habernern, Cocoa Beach, FL.

I very much enjoyed "Build the Cosmac 'Elf'" in the August issue. The price and complexity were just at my level.—D. Morris, Midland, MI.

I really appreciated the Cosmac "Elf" article. I intend to build it as soon as I have found suppliers for the parts. In my search for the parts, I have encountered some problems:

(1) The article says that the CDP 1802 microprocessor sells for less than \$30. The only supplier that I could find for the chip sells it for \$40.

(2) The memories called for are 2101 (256 × 4). Every 2101 I can find is 256 × 1.

(3) I have been unable to find the 5082-7340 hex displays anywhere. I realize that others could be substituted but I would like to use the one suggested.—David Borgelt, Kingdom City, MO.

In answer to Dave's questions, we have the following information: (1) The MPU you want is CDP1802CD. (The last CD means 4-6-volt operation in a ceramic package.) It sells for \$29.50. RCA tells us that the MPU has been in short supply due to the heavy demand, but it should be available again soon. A list of RCA-appointed distributors around the country and CDP1802CD data sheets are available free of charge from: RCA Solid State Division, Box 3200, Somerville, NJ 08876.

(2) Despite what some advertisements may say, the 2101 is 256 × 4.

(3) The 5082-7340 displays are available from most distributors who carry Hewlett-Packard products.

### A BETTER CURVE TRACER

I would like to make a few comments about the circuit in "Curve Tracer Checks Semiconductor Quality" (March 1976). First, this circuit will not check zener diodes rated at voltages greater than the transformer's 12.6-volt secondary potential. Any zener diode rated at greater than this voltage will produce a trace like an ordinary pn junction. Secondly, the largest capacitance that can be tested is 1 μF. Values greater than this will produce a

"shorted" trace, while values less than 0.033 μF will produce an "open" trace. The limitation here is the 60-Hz line frequency; a possible answer to this would be to use a signal generator in lieu of the filament transformer. Finally, with the base open, a true picture of the device under test cannot be represented, since the base-emitter junction is very important to the operation of the device. The Beta test circuit can be enhanced by use of a signal generator to permit the frequency to be changed and thus give a better picture of gain.

Below is a circuit I have used quite often for testing semiconductors, rheostats, capacitors, and coils. The variable transformer allows for a wider range of test voltages to solve the zener test problem. Power transistors can also be easily tested, using

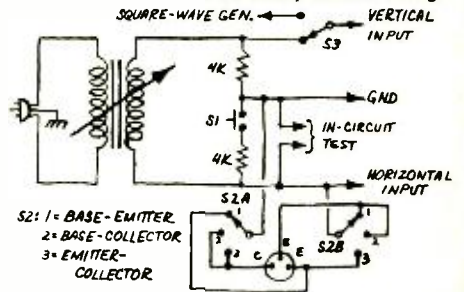

a calibrated dial to list selected test voltages. Switch S3 can be used to switch in an external square wave (scope calibrator or signal generator) for ringing coils. Switch S2 provides fumble-free out-of-circuit testing.—D.D. Dempsey, Fort Gordon, GA.

### VIDEO GAME READER NOTES

I've seen two table tennis (April 1976) games that have the same flaw: The vertical interval from the vertical sync generator (Fig. 2) is too long. I've seen it as long as 28 lines when it's supposed to be only three horizontal lines. Also, with the components specified, a 60-Hz vertical rate can't be obtained. I've discovered that by increasing the value of C3 to 0.15 or 0.12 μF and decreasing the value of R10 to 1500 ohms, the problem will clear up, and tearing at the top of the displayed picture will cease.—Cary Sagady, Lindenwold, NJ

I couldn't resist building the "Space War" game (April 1976), but when I got it up and running, the space ships remained at the top of the screen and I had little control over their positioning. I discovered that the trailing edge of the 555's output occurred about 1 ms after the vertical sync pulse. By changing the values of C14 and C15 to 4.7 μF and inserting a 470-ohm resistor in series with each position-control potentiometer's wiper, I solved the problem.—Charles F. Brillowsky, Southgate, MI

### ULTRA-UNIQUE DEVICES

It appears that POPULAR ELECTRONICS is continuing with construction projects that contain ultra-unique components. After

POPULAR ELECTRONICS



# EVERY PROJECT IN THIS BOOK IS ANOTHER REASON TO OWN CSC'S QT SOCKETS AND BUS STRIPS.

With QT solderless bread-boarding sockets and bus strips, you can build twice the projects in half the time. Because making connections or circuit changes is as fast as pushing in—or pulling out—component leads. No special clips or jumpers required, either.

When you're building circuits just for the fun of it, you can take them apart in minutes—not hours. So you save money by re-using parts, while eliminating heat damage to expensive components. Interlocking QT Sockets and Bus Strips are infinitely expandable, too: start small and "grow" breadboards as large as you wish.

For as little as \$3.00, you can get a lot more out of your time in electronics—so why not treat yourself to a QT Socket today?

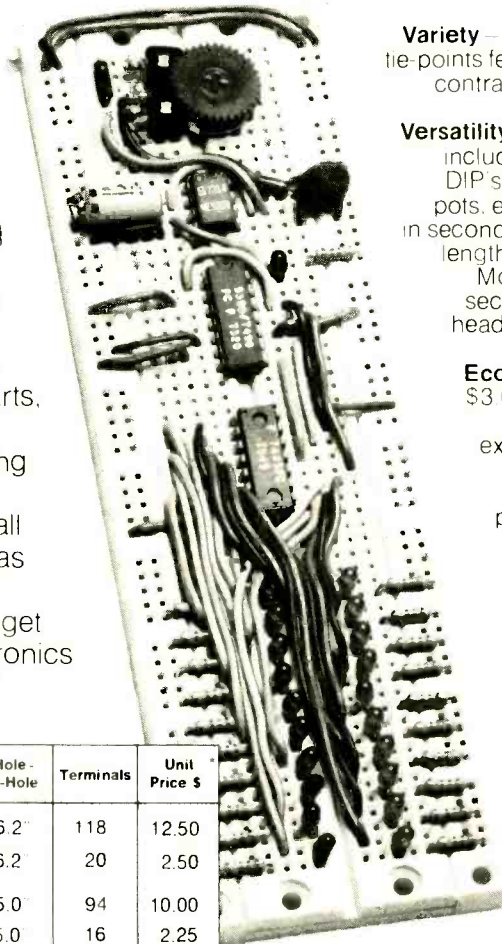

**Variety**—10 models from 70 to 590 solderless tie-points feature snap/lock design to expand or contract your breadboard to fit every circuit and budget requirement.

**Versatility**—Use with virtually all types of parts, including resistors, capacitors, transistors, DIP's, TO-5's, LED's, transformers, relays, pots, etc. Most plug-in directly and instantly in seconds. No special jumpers required—just lengths of #22-30 AWG solid hookup wire.

Molded-in holes let you mount QT units securely on any flat surface with 4-40 flat head screws, or 6-32 self-tapping screws, from behind panel.

**Economy**—Sockets are priced as low as \$3.00\*. Save more money by eliminating heat and mechanical damage to expensive parts, re-using components.

**Speed**—For fast circuit layouts, QT Sockets have 5 interconnecting tie-points per terminal. Bus Strips feature 2 separate rows of interconnecting terminals. Both connect and disconnect easily, without damage to socket or parts.

**Visibility**—All parts are instantly and easily visible and accessible, for quick signal tracing, circuit analysis and diagramming.

**Durability**—Higher-temperature sockets with abrasion-resistant, glass-filled plastic, rated better than 100°C. Screw-down and interlocked design provides high mechanical strength.

**Reliability**—Ruggedly designed to professional engineering standards, for heavy day-in, day-out use. Non-corrosive prestressed nickel-silver contacts insure more secure mechanical and electrical connections. Vinyl backing prevents shorting when mounted on conductive surfaces.

Length Hole-to-Hole		Length	Hole-to-Hole	Terminals	Unit Price \$
	QT-59S	6.5"	6.2"	118	12.50
	QT-59B	6.5"	6.2"	20	2.50
	QT-47S	5.3"	5.0"	94	10.00
	QT-47B	5.3"	5.0"	16	2.25
	QT-35S	4.1"	3.8"	70	8.50
	QT-35B	4.1"	3.8"	12	2.00
	QT-18S	2.4"	2.1"	36	4.75
	QT-12S	1.8"	1.5"	24	3.75
	QT-8S	1.4"	1.1"	16	3.25
	QT-7S	1.3"	1.0"	14	3.00

All QT units are .33" thick

CONTINENTAL SPECIALTIES CORPORATION



See your CSC dealer or call 203-624-3103 (East Coast) or 415-421-8872 (West Coast) major credit cards accepted.

\*Manufacturer's suggested list • Prices and specifications subject to change without notice

© 1976, Continental Specialties Corporation

44 Kendall Street, Box 1942  
New Haven, CT 06509 • 203-624-3103 TWX 710-465-1227  
West Coast office, Box 7809, San Francisco, CA 94119 • 415-421-8872

TWX 910-372-7992

Canada: Len Finkler Ltd., Ontario



# If you thought a rugged, professional yet affordable computer didn't exist,

## think IMSAI 8080.

Sure there are other commercial, high-quality computers that can perform like the 8080. But their prices are 5 times as high. There is a rugged, reliable, industrial computer, with high commercial-type performance. The IMSAI 8080. Fully assembled, it's \$931. Unassembled, it's \$599. And ours is available now.

In our case, you can tell a computer by its cabinet. The IMSAI 8080 is made for commercial users. And it looks it. Inside and out! The cabinet is attractive, heavy-gauge aluminum. The heavy-duty lucite front panel has an extra 8 program controlled LED's. It plugs directly into the Mother Board without a wire harness. And rugged commercial grade paddle switches that are backed up by reliable debouncing circuits. But higher aesthetics on the outside is only the beginning. The guts of the IMSAI 8080 is where its true beauty lies.

The 8080 is optionally expandable to a substantial system with 22 card slots in a single printed circuit board. And the durable card cage is made of commercial-grade anodized aluminum.

The IMSAI 8080 power

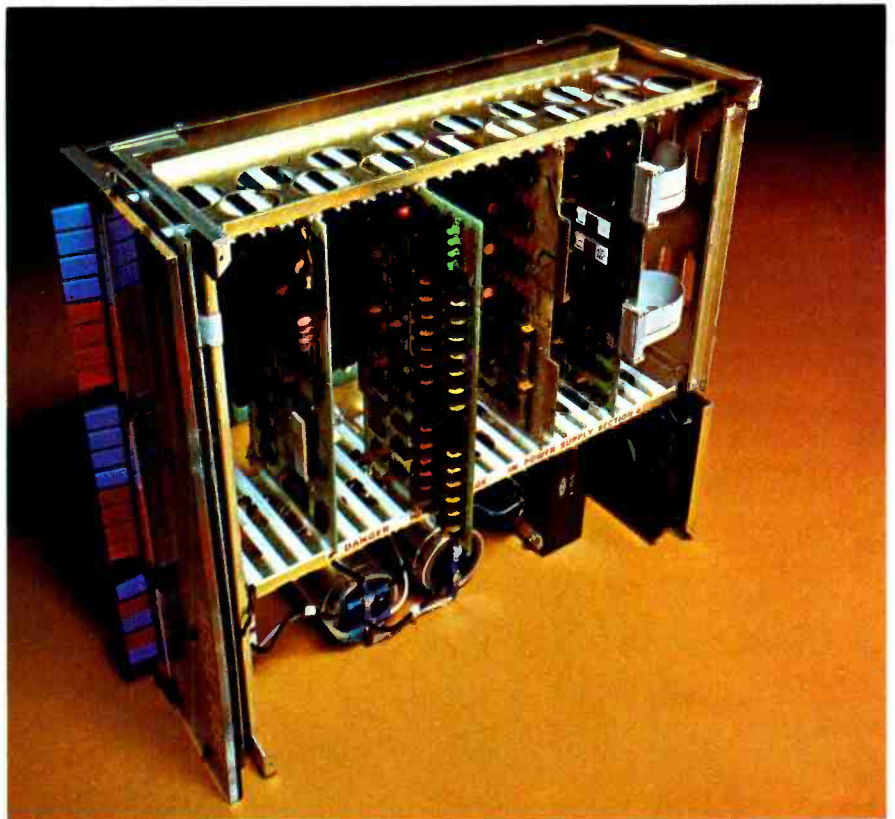

supply produces a true 28 amp current, enough to power a full system.

You can expand to a powerful system with 64K of memory, plus a floppy disk controller, with its own on-board 8080—and a DOS. A floppy disk drive, an audio tape cassette input device, a printer, plus a video terminal and a teleprinter. These peripherals will function with an 8-level priority interrupt system. IMSAI BASIC software is available in 4K, that you can get in PROM. And a new \$139 4K RAM board with software

memory protect. For the ultimate in flexibility, you can design the system for low-cost multiprocessor, shared memory capability.

Find out more about the computer you thought didn't exist. Get a complete illustrated brochure describing the IMSAI 8080, options, peripherals, software, prices and specifications. Send one dollar to cover handling.

Call us for the name of the IMSAI dealer nearest you.

Dealer inquiries invited.



## IMSAI

IMS Associates, Inc.  
14860 Wicks Boulevard  
San Leandro, CA 94577  
(415) 483-2093

PE-10



## New Products

Additional information on new products covered in this section is available from the manufacturers. Either circle the item's code number on the Reader Service Card inside the back cover or write to the manufacturer at the address given.

### SWL FREQUENCY CALIBRATOR

Gilfer Associates' Model C-10 calibrator provides selectable marker signals every 10, 25, 50, 100, and 1000 kHz across the long- and short-wave regions of the radio spectrum. A front-panel gating switch enables identification of markers even on a crowded band. The calibrator uses 3 CMOS IC's and a transistor amplifier, and draws low current from an internal 9-volt battery. Enclosed in a Ten-Tec cabinet. \$54.00. Address: Gilfer Associates, 52 Park Avenue, Box 239, Park Ridge, NJ 07656.

### 2-METER FM TRANSCEIVER

Regency Electronics has introduced a new 2-meter FM amateur transceiver, the Model HR-312. Selection of 12 crystal-controlled simplex channels or 144 transmit/receive frequency combinations is made by lock-



ing or unlocking the transceiver's mode switch. Adjacent channel selectivity is rated at 75 dB, intermodulation rejection at 65 dB, and receiver sensitivity at 0.15  $\mu$ V at 12 dB SINAD. Transmitter power is rated at 35 watts. Comes with a mounting bracket and a PTT microphone. \$269.00.

CIRCLE NO. 85 ON FREE INFORMATION CARD

### SHURE STEREO/FOUR CHANNEL CARTRIDGE

The new Shure Model M24H Dynetic cartridge features low effective stylus mass (0.39 mg), and a hyperbolic diamond stylus tip, making it suitable for use with stereo, matrix, and discrete quadrasonic discs. Its frequency range is said to be 20 to

10



50,000 Hz, its output 3.0 mV per channel at 1000 Hz with a 5 cm/sec peak recorded velocity, and channel balance within 2 dB. Channel separation is rated at a minimum of 22 dB at 1000 Hz. Typical trackability at 1/4 grams in a Shure/SME tone arm is 20 cm/sec at 400 Hz and 25 cm/sec at 30,000 Hz, with a peak of 50 cm/sec at 10,000 Hz. Tracking force ranges from 1 gram minimum to 1 1/2 grams maximum, with an optimum figure of 1 1/4 grams. Net weight is 6 grams. \$74.95.

CIRCLE NO. 86 ON FREE INFORMATION CARD

### CB BASE MIKE WITH PREAMP

The new Expander 500 from Turner is a base-station microphone with a built in preamp. Slide-type volume and tone controls, together with a meter, allow the user to adjust the microphone output for



maximum intelligibility. The meter also functions as a battery-condition indicator when used with a press-to-test button. The mike head has adjustable tilt and a press-to-talk bar with a slide lock. Comes with a six-conductor (one shield) cable. \$65.00.

CIRCLE NO. 87 ON FREE INFORMATION CARD

### WESTON PORTABLE LCD DMM

Weston Instruments' new Model 6000 is a portable digital multimeter with autoranging for five measurement functions: ac voltage, ac current, dc voltage, dc current, and resistance. Twenty-six ranges cover voltage measurement from 200 mV to 1000 V, current from 2 mA to 10 amperes, and resistance from 200 ohms to 20 megohms. A HOLD input jack provides memory reten-

tion capability for remote measurements. Automatic zero and automatic polarity are built-in. Accuracy for the Model 6000 is said to be 0.35%. The 3 1/2-digit liquid crystal display has 0.5-inch high characters, and blinks on over-range. Uses two 9-volt transistor batteries. Measures 7" x 5.75" x 2.25" (17.8 x 14.6 x 5.7 cm); weighs less than 2 lb. \$195.00.

CIRCLE NO. 88 ON FREE INFORMATION CARD

### CORDLESS SOLDERING IRON

Wahl Clipper Corp.'s new Model Iso-Tip 60 is a rechargeable soldering iron that is said to be able to heat up to 125 joints on a single charge. It can be recharged from "dead" to "full" in one hour, at which point



a LED indicator lights. The iron can be kept in its recharging stand, where it will be trickle-charged if the battery is not discharged or fast-charged if it is low. The standard cordless soldering kit, Model 7800, includes the Iso-Tip 60 soldering iron, recharging stand, a fine tip, a chisel tip, and an instruction booklet. The iron will also accommodate any of Wahl's 16 snap-in soldering tips.

CIRCLE NO. 89 ON FREE INFORMATION CARD

### BIC MONITOR SERIES LOUDSPEAKER

The new Formula 7 speaker system by BIC Venturi has a ported bass reflex design with a 12-inch woofer, a "T-slot" horn assembly with a dynamic compression driver for the midrange and lower treble, and a piezo-electric driver for the upper treble range. It also features an amplifier clipping indicator which glows when the amplifier is being over-driven. The woofer and midrange/treble transducer are protected by overload indicator lights and circuit breakers. Also included are a midrange/treble level control, a dynamic tonal balance circuitry, and a series of indicators which measure the output sound level over a range of 75 to 117 dB. Claimed frequency range is 20 Hz to beyond 30,000 Hz; power handling is rated at 125 W rms/channel; dispersion is 180° horizontal, 120° vertical. Nominal impedance is 6 ohms. Cabinet

POPULAR ELECTRONICS

# The small wonder



# of the micro-world

Measuring just 11" wide x 11" deep x 5" high, and weighing a mere 7 pounds, the Altair™ 680b is a complete, general-purpose computer.

The secret to this revolutionary, small computer is its CPU board. This double-sided board fits along the bottom of the Altair case and plugs directly into the front panel board. It contains the new 6800 microprocessor, 1,024 bytes of RAM memory, a 256 byte PROM monitor, provisions for 768 bytes of additional PROM or ROM, and a single Interface port with a Motorola ACIA serial interface adapter which can be configured either RS-232 or TTY. A five level Baudot interface option is also available.

The Altair 680b can be programmed from front panel switches, or it can be interfaced to a video display terminal, or teletypewriter. Three additional circuit boards can be plugged inside the Altair 680b for further memory and interface expansion. The first of these boards is a 16K static RAM memory board.

Software already developed includes Altair 680 BASIC with all the features of the 8K BASIC previously developed for the Altair 8800. These include Boolean operators, the ability to read or write a byte from any I/O port or memory location, multiple statements per line, and the ability to interrupt program execution and then continue after the examination of variable values. This software takes only 6.8K bytes of memory space and a copy is included free with the purchase of the Altair 680 16K memory board.

Other software includes a resident two pass assembler. The Altair 680b is also compatible with Motorola 6800 software.

The Altair 680b is ideal for hobbyists who want a powerful computer system at an economic price. Altair 680b owners qualify

for membership in the Altair Users Group, and like other Altair owners, they receive a complimentary subscription to **Computer Notes** and complete factory support.

#### PRICES:

Altair 680b kit with complete, easy-to-understand assembly manual, operator's manual, and programming manual .....	\$466
Assembled Altair 680b .....	\$625
Altair 680b Turnkey model kit .....	395
Expander Card 680MB (required to expand 680) .....	\$ 24
Altair 680BSM 16K static RAM board kit with 680 BASIC .....	\$685
Altair 680 BASIC when purchased separately .....	\$200
Baudot option .....	\$ 42

#### MAIL THIS COUPON TODAY

- Enclosed is a check for \$\_\_\_\_\_
- BankAmericard # \_\_\_\_\_ or Master Charge # \_\_\_\_\_
- Altair 680b  Kit  Assembled  Other (specify) \_\_\_\_\_
- enclose \$8 for postage and handling
- Please send free information package

NAME \_\_\_\_\_

ADDRESS \_\_\_\_\_

CITY \_\_\_\_\_ STATE & ZIP \_\_\_\_\_



2450 Alamo SE/Albuquerque, NM 87106, 505-243-7821

NOTE: Altair is a trademark of MITS, Inc.

Price, specifications subject to change. Please allow up to 60 days for delivery.

OCTOBER 1976

CIRCLE NO. 82 ON FREE INFORMATION CARD

11

# Three different schools give you this 25" DIAGONAL hobby-kit Color TV...

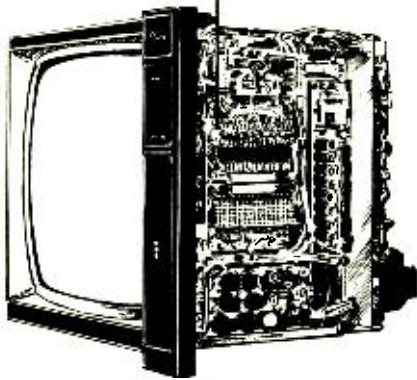

No other home training school gives you both an exclusive solid state color TV and an SQ® Quadraphonic Receiver complete with four speakers . . . all in one course. You get both for hundreds of dollars less than the combined tuition cost of TV and Audio courses at another school. And only NRI's Master Course in Color TV/Audio servicing lets you train on equipment specifically designed for training with exclusive "power-on" features.

NRI doesn't give you hobby kits or commercial sub-assemblies. We invested the time and money to design equipment with learning in mind.

# Only NRI gives you this 25" DIAGONAL designed-for-learning Color TV...

It's the only way you can (1) get the feel of typical commercial circuitry, (2) learn bench techniques while building complete units from the "ground" up, (3) perform over 35 "in-set" experiments during construction, and (4) end up with a 25" diagonal solid-state color TV with console cabinet and a 4-channel quadraphonic Audio Center.

## **NRI passes the savings on to you**

NRI can save you money because our engineering eliminates the cost of buying from an outside source. We pay no salesman's commission. Students are enrolled by mail only. The savings are passed on to you in the form of low tuition fees, extras like the TV's console cabinet and the four speaker Quadraphonic System; a 5" triggered sweep

oscilloscope, CMOS digital frequency counter, and an integrated circuit color TV pattern generator. Where NRI supplies a professional color

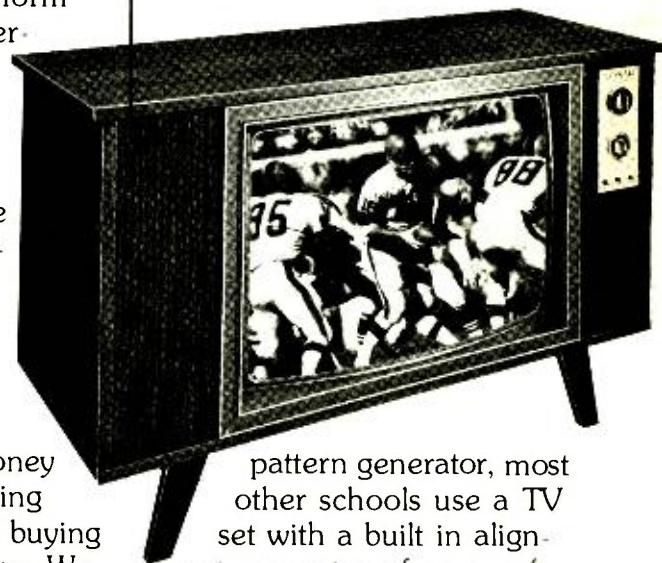

pattern generator, most other schools use a TV set with a built in alignment generator of no use for servicing other sets. Only NRI designs, engineers, and supplies training kits specifically for learning and professional use. You can pay hundreds of dollars more for a similar course and not get a nickel's worth more in training and equipment.

® Trademark of CBS, Inc.

# ...plus complete Quadraphonic Audio Center!

## More know-how per dollar

That's what it all boils down to, the quality of training you get for the money you spend. In our 62-year history, more than a million students have come to NRI and we're fully approved for career study under the G.I. Bill. We must be teaching something right. Some of those "right" things are bite-size lessons to ease understanding and speed learning . . . personal consultation, and prompt grading of all tests . . . a full-time staff of engineer/instructors to help if you need it . . . plenty of kits and experiments to give you hands-on training . . . and fully professional

programs oriented to full or part-time career needs.

**Widest Choice of Courses with Communications, CB, Digital Computer, and other careers.**

NRI offers not one, but five excellent TV/Audio servicing courses so you can tailor your training to your budget.

Or you can study other opportunity fields like Digital Computer Electronics, Citizens Band Radio, Communications, Aircraft or Marine Electronics, Mobile Radio, and more. Send

for our free catalog and see for yourself that no one gives you more training and equipment for your dollar. There's no obligation, and no salesman will call.

If card is missing, write to:



**NRI SCHOOLS**  
McGraw-Hill Continuing  
Education Center  
3939 Wisconsin Avenue,  
Washington, D.C. 20016



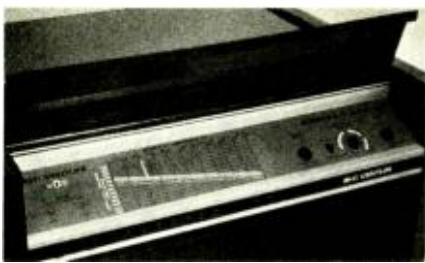

finish is walnut veneer, and front grille is dark brown. Measures 41¼" H x 16" W x 13¾" D (104.8 x 40.6 x 34.9 cm), weighs 88 lb (40 kg). \$445.

CIRCLE NO. 91 ON FREE INFORMATION CARD

### BREAKER CB BURGLAR ALARM

The Model 13-188 CB burglar alarm from Breaker Corp actuates the horn of the ve-

hicle in which it is installed if the ground connection to either the antenna or the transceiver is broken. Once actuated, the horn will continue to sound — even if the ground connection is quickly restored — until the alarm is reset. Designed for use in vehicles with 12-volt negative- or positive-ground electrical systems, the alarm is said to be easy to install. \$21.95.

CIRCLE NO. 92 ON FREE INFORMATION CARD

### CB QUAD BASE ANTENNA

The Avanti PDL II is a cubical quad base station antenna. It has two elements and a gamma match which dc grounds the antenna. Front-to-back rejection is rated at 32 dB. VSWR is said to be 1.2:1. Boom length is 4'10" (1.5 m). Requires a light-to-medium duty rotor. The quad uses aluminum tubing

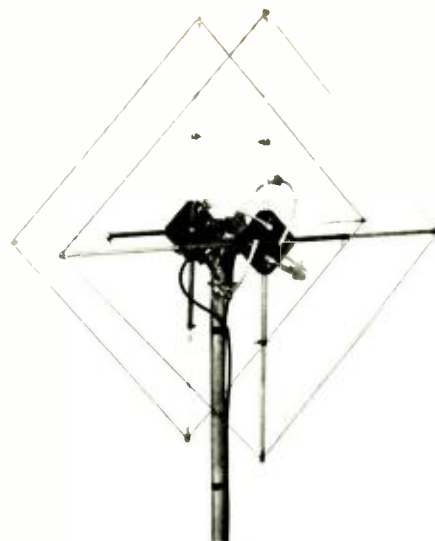

spreaders, cast aluminum hubs, stainless steel clamps and cadmium-plated hardware. \$108.95.

CIRCLE NO. 93 ON FREE INFORMATION CARD

### RF SIGNAL GENERATOR

VIZ Test Instruments Group has introduced its Model WR-50C solid-state signal generator, a successor to the RCA WR-50B. It covers fundamental frequencies from 85 kHz to 40 MHz in six ranges, and harmonic outputs for higher frequencies. The range-selection switch also has two



positions for 455 kHz and 10.7 MHz sweep outputs for AM and FM radio i-f alignment. R-f output is rated at 75 mV minimum. The generator has a built-in modulator and a crystal controlled oscillator circuit with front-panel crystal socket for markers or calibration. A two-step 10:1 attenuator switch is included, as are a vernier attenuation control for sweep output, and a two-position 7:1 attenuator switch for crystal oscillator output. Measures 7¾" x 5⅞" x 4⅞" (19.7 x 14.9 x 10.5 cm). \$117.00.

CIRCLE NO. 94 ON FREE INFORMATION CARD

### TECHNICS INTEGRATED STEREO AMPLIFIER

The new Model SU-8600 from Technics by Panasonic has a rated power output of 73 watts per channel minimum (rms) at 8 ohms from 20 to 20,000 Hz with no more than 0.08% total harmonic distortion. It is a complementary direct-coupled OCL power

POPULAR ELECTRONICS

## NOW FROM TEXAS INSTRUMENTS . . . three machines in one.

programmable  
slide-rule calculator  
SR-52

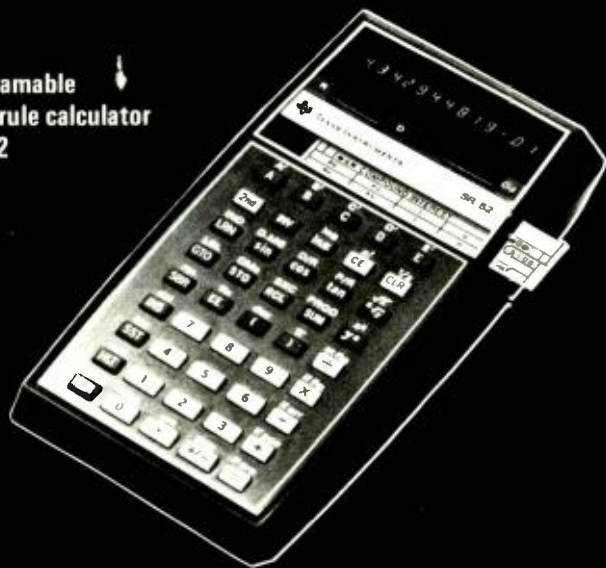

- 10 user defined keys
- 8 preprogrammed condition statements
- 224 program storage locations
- 20 independent addressable memory registers
- 23 preprogrammed key functions
- Permanent program storage on magnetic cards

It took TEXAS INSTRUMENTS to invent the SR-52 calculator. It took C & S MARKETING ASSOCIATES to offer it at a price you can afford, now only \$249.95. With such versatility and such an affordable price, you can not afford to be without the problem solving power of card programmability. Now solve problems in seconds that would take hours with an ordinary calculator or slideruler if they could be done at all.

For more information or the answer to any question you may have about the SR-52 calculator, call toll free (800-251-6771)\*. Tenn. residents call (800-262-6706). Other TEXAS INSTRUMENT models available from \$49.95.

Each TEXAS INSTRUMENT calculator comes with a 1-year warranty. Should your unit prove defective within 60 days, just return it for a new unit! Finally should you be dissatisfied with your calculator return it within 15 days for a prompt refund. \* COD orders please add \$5.00 shipping and handling.

**C & S MARKETING ASSOC.**  
P.O. BOX 165 ALGOOD, TENN. 38501

QTY. \_\_\_\_\_ PRICE 249.95 ea.

CHECK     M.O.     C.O.D.

NAME \_\_\_\_\_

ADDRESS \_\_\_\_\_

CITY, ST., ZIP \_\_\_\_\_

CIRCLE NO. 16 ON FREE INFORMATION CARD





**When you've got a Pace CB radio,**



**you've got the world by the ears.**

There are millions out there with their ears on waiting to talk to you Pace to Pace.

And with a Pace CB two-way radio you've got every bit of power the law allows. Power to cut through interference and "bleeders" from other channels.

What's more, it's assembled with computerized circuitry and it's 100% solid state, so it's as trouble-free as a CB can be.

It all adds up to your voice getting out there clearer and with less distortion, and the

other guy's voice coming back just as clear.

To learn more, drop into a Pace place near you. The dealer will tell you just how economical and easy-to-install a Pace is. He'll help you choose the one that's just right for you, too.

Ask him for the best-selling CB in the world. He'll know which one you're talking about.



**PACE CB**

PACE TWO-WAY RADIO PRODUCTS,  
BY PATHCOM, INC., HARBOR CITY, CA 90710

## Saving the best for last.

The chances are good that when you first bought a stereo system, it was a "package" that included a receiver, 2 speakers, and a record player with cartridge. But how much time was spent selecting the cartridge? Most probably it was just a minor element of the package. Even if it had a famous name, it probably was not a truly first-rank model.

Yet the cartridge is more important than that. It can limit the ability of the entire hi-fi chain to properly reproduce your records. It can affect how many times you will enjoy your favorite records without noise and distortion. And it can determine whether you can play and enjoy the new four-channel CD-4 records.

Consider the advantages of adding an Audio-Technica AT15Sa to your present system. You start with response from 5 to 45,000 Hz. Ruler flat in the audio range for stereo, with extended response that assures excellent CD-4 playback if desired. Tracking is superb at all frequencies and distortion is extremely low. The sound is balanced, transparent, effortless. Stereo separation is outstanding, even at 10kHz and higher where others fall short. Our Dual Magnet design\* assures it.

And the AT15Sa has a genuine nude-mounted Shibata stylus. Which adds a host of advantages. Like longer record life. Better performance from many older, worn records. Exact tracing of high frequencies, especially at crowded inner grooves. And tracking capability—at a reasonable 1-2 grams—that outperforms and outlasts elliptical styli trying to track at less than a gram.

We're so certain that an AT15Sa will improve your present system that we'd like to challenge you. Take several of your favorite records to an Audio-Technica dealer. Have him compare the sound of your present cartridge (or any other) with the AT15Sa. Listen. We think you'll be impressed. And convinced.

\*T.M. Audio-Technica Dual Magnet cartridges protected by U.S. Patent Nos. 3,720,796 and 3,761,647.

## The AT15Sa. Very possibly the last phono cartridge you'll ever need.



 **audio-technica**<sup>®</sup>  
 INNOVATION □ PRECISION □ INTEGRITY

AUDIO-TECHNICA U.S., INC., Dept. 106P, 33 Shilwassee Ave., Fairlawn, Ohio 44313  
 Available in Canada from Superior Electronics, Inc.

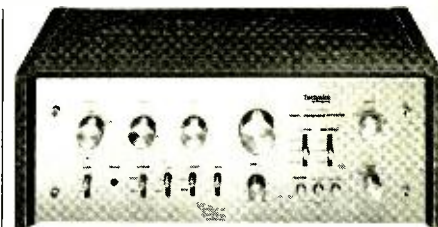

amplifier with differential input stage and an emitter follower for impedance matching. It also has a 2-stage phono equalizer. A current-mirror differential amplifier is employed in a 3-stage direct-coupled tone-control circuit. Other features include a turnover frequency selector, a tone-defeat switch, a 26-step attenuator-type level control with loudness switch, -12-dB/octave low and high filters, a -20-dB audio muting switch, two speaker system outputs, two tape monitor loops, a head-phone jack, and inputs for two phono-graphs, a tuner, and an auxiliary signal source. \$329.95.

CIRCLE NO. 95 ON FREE INFORMATION CARD

### CB CHANNEL BILLBOARD

Controls/Inc. announces its new CB Channel Billboard Advertiser, which allows a mobile operator to display which channel he is monitoring. It is composed of two units. One is a display box with 2-inch (5-cm) seven-segment numerals to indi-



cate the monitored channel. It can be mounted on the rear deck of an automobile or in any other visible location. The second unit is a control box with a 24-position rotary switch (1 through 23 and OFF). The two are interconnected by means of a flat ribbon cable. Requires 12 volts dc, and comes with mounting brackets and hardware. Address: Controls/Inc., Box 522, Consumer Sales Dept. 17, Logansport, IN 46947.

### DBX SIGNAL PROCESSOR

The Model 128 signal processor by dbx contains a two-channel record/playback noise reduction system similar to the dbx Model 122, and a 2:1 dynamic range enhancement providing linear compression and expansion. The noise-reduction system is said to provide 30 dB of noise reduction and 10 dB headroom improvement when used for live recording and to prevent hiss and noise build-up when copying previously recorded material off a disc or tape. The dynamic range enhancement section offers restoration up to 20 dB of the

POPULAR ELECTRONICS

# The Black Watch Kit \$19.95

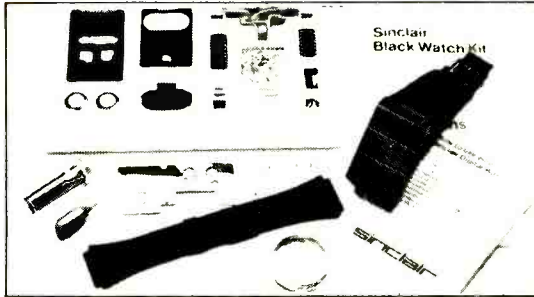

## THE KIT CONTAINS

1. printed circuit boards
  2. integrated circuits
  3. encapsulated quartz crystals
  4. trimmers
  5. capacitors
  6. LED displays
  7. 2-part case with window in positions
  8. batteries
  9. battery-clip
  10. black strap (black stainless-steel bracelet optional extra — see order form.)
  11. full instructions for building and use.
- All you provide is a fine soldering iron and a pair of cutters.

The Black Watch Kit by Sinclair is unique. Controlled by a quartz crystal...powered by two hearing aid batteries. Styled in understated elegance the Sinclair way. No knobs no buttons. To see the exact time or date just touch the face of the case. A re-set control is on the back.

Dimensions: 1-1/2" X 1" X 3/10"  
 Weight: 1/2 ounce  
 Strap: 3/4" wide  
 Case: Specially designed unbreakable black matte plastic. Water resistant.  
 Batteries: Mallory RM41H  
 Accuracy: On a built watch we guarantee accuracy within a second a day. In building it yourself you may be able to adjust the trimmer to achieve an accuracy within a second a week.



**sinclair** (Actual Size)

# Scientific Calculator Kit \$14.95



## KIT COMPONENTS

1. Coil
2. LSI chip
3. Interface chips
4. Printed circuit board
5. Keyboard panel
6. Electronic components pack
7. Battery assembly and on/off switch
8. Case moldings, with buttons windows and light-up/display in position. Soft carrying case
9. Comprehensive instructions
10. Assemble time is approximately 3 hours.

Designing the Sinclair Scientific was no small feat of engineering, but you don't have to be an engineer to assemble it with our kit.

You can put together the world's most remarkable scientific calculator from eight groups of components, using only a soldering iron and a pair of cutters. (Complete instructions are included.) Less than 3/4-inch thin and 3-3/4 ounces light. British-made Sinclair Scientific isn't just portable, it's pocketable.

All parts are tested before shipment — and we guarantee any correctly assembled calculator for one year.

## Features of the Sinclair Scientific

### FUNCTIONS SUMMARY —

Algebraic logic  
 Five function memory  
 Sine, cosine, tangent, arcsine, arccosine, arctangent  
 Degrees/radians switch  
 Ln and e<sup>x</sup>  
 Square root, pi and reciprocal  
 8 digit mantissa, plus 2 digit exponent  
 Automatic constant  
 Pocket-sized: 4-1/3" X 2" X 11/16"  
 Weight: 4 ounces.  
 Battery life. Low-cost, disposable AAA batteries (not included) operate for around 25 hours of continuous use.

1. **FREE TRIAL OFFER** If you decide not to keep and assemble your kit, you may return it undamaged within 10 days for a refund of its purchase price.

2. **SERVICE** If a problem arises in building your kit, Sinclair Service Department will fix it for you at a nominal charge.

3. **WARRANTY** Your correctly assembled kit will be repaired or replaced by Sinclair if it fails to operate within one year of purchase free of charge (except in the case of misuse).

4. To order your kit, just use the coupon and mail it with your check or money order to: GFN Industries, Inc., 6 Commercial Street, Hicksville, New York 11801.

To: GFN INDUSTRIES, INC., 6 Commercial Street, Hicksville, New York 11801

Black Watch Kit(s) at \$19.95 ..... \$ \_\_\_\_\_  
 Black Watch Kit(s) with stainless steel band at \$24.95 ..... \$ \_\_\_\_\_  
 Scientific Calculator Kit(s) at \$14.95 ..... \$ \_\_\_\_\_  
 Assembled Black Watch(es) with stainless steel band at \$39.95 ..... \$ \_\_\_\_\_  
 Assembled Scientific Calculator(s) at \$19.95 ..... \$ \_\_\_\_\_  
 Sales Tax (N.Y. Residents) ..... \$ \_\_\_\_\_  
 Shipping and handling (\$2.00 PER UNIT) ..... \$ \_\_\_\_\_  
 Enclosed is check/MO (payable to GFN Industries Inc.)  
**TOTAL** ..... \$ \_\_\_\_\_

NAME \_\_\_\_\_

ADDRESS \_\_\_\_\_

CITY \_\_\_\_\_ STATE \_\_\_\_\_ ZIP \_\_\_\_\_

Quantity discount: For 6 or more units, the total shipping and handling charge is \$5.00.

KEY # PE-10WC

# THE POLY 88 MICROCOMPUTER

A Complete Microcomputer System with Keyboard Input and Video Output

**The Hardware:** The heart of the POLY 88 microcomputer, the CPU circuit card, features an 8080A central processor, 512-byte RAM, space for 3K of PROM, vectored interrupt and real time clock, a dual serial port with software-selectable baud rate, and single-step logic

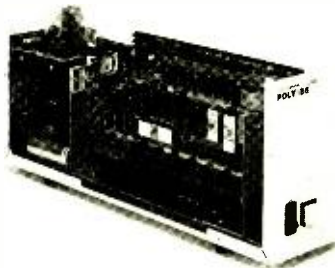

that allows the processor to execute one instruction at a time.

The POLY 88 also includes our video terminal interface circuit card, which is both a video display device and an input port for a keyboard. Sixteen lines of up to 64 characters may be displayed on a standard TV monitor or modified receiver. In addition to the 128 ASCII characters

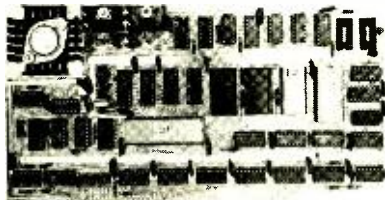

which are displayed in an easy-to-read 7 x 9 font, there are 64 graphics characters available for plotting on a 48 x 128 contiguous grid.

These two circuit cards fit into a compact "Altair-compatible" chassis with room for up to five cards. A 6 amp power supply is built right on the mother board. The front panel consists of just two switches, on/off and reset; the monitor software with video screen and keyboard eliminates the need for a hardware front panel. As your system grows, you can plug chassis together for easy expansion. (The expansion connector also eliminates the need for an extender card.) Cassette, RS-232, and current loop interfaces are available which connect via ribbon cable to CPU board and mount on backpanel.

**The Software:** Supplied with the POLY 88 microcomputer is a 1024-byte monitor on ROM. The program is there when the power is turned on, so you don't need to key in a loader. The monitor is designed to use a keyboard entry and TV display, with a cassette or paper tape as the storage medium.

With the monitor you can: load data into memory in hex, display memory in hex, dump or read data from a storage device, and execute program one step at a time, displaying the contents of each of the 8080 registers as well as the values in memory at the address of each of the

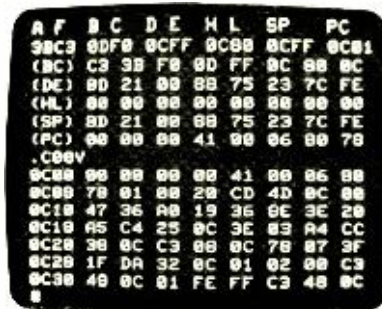

registers. All of these functions are available the instant you turn on the power.

Future software available with this system will include BASIC, an assembler, and games.

**Prices:** Basic kit including chassis, CPU and video cards — \$595, \$795 assembled. Cassette option — \$90 kit and \$125 assembled. 8K of RAM — \$300 in kit form or \$375 assembled. We also sell the video and other "Altair-compatible" circuit cards separately.

**Dealers:** This system sells itself.

All prices and specifications subject to change without notice. Prices are USA only. California residents add 6% sales tax. Prepaid orders shipped postpaid. BankAmericard and Master Charge

- Please send more information
- Order and check enclosed

Name \_\_\_\_\_

Address \_\_\_\_\_

BankAmericard  
Master Charge \_\_\_\_\_

## PolyMorphic Systems

737 S. Kellogg, Goleta, CA 93017 (805) 967-2351



dynamic range of an original performance that has been previously recorded. The two sections can be used independently or in tandem by means of front panel switching.

CIRCLE NO. 96 ON FREE INFORMATION CARD

### SONAB BELT-DRIVE TURNTABLE

The Sonab Model 67S is a new Swedish manual record turntable offering two operating speeds (33-1/3 and 45 rpm). A 24-pole synchronous motor drives a 2.7-lb (1.2-kg) nonmagnetic platter through a belt. Wow is said to be less than 0.08% (DIN), and rumble better than 60 dB down. Its tonearm has a needle-and-ball-bearing support system, and can be used with cart-



ridges weighing from 4 to 12 grams. Other features include an onboard spirit level and adjustable feet for leveling adjustments, oil-damped manual cueing, a lightweight cartridge shell and adjustable weights for tracking force and antiskating adjustments. Connecting lead capacitance is 100 pF maximum. Measures 17" x 14" x 5" (435 x 350 x 150 mm), and weighs 15.5 lb (7 kg). Supplied with dust cover. \$240.

CIRCLE NO. 97 ON FREE INFORMATION CARD

### DIGITAL TURNTABLE STROBE

Woodard Electric's Digital Strobe is a crystal-controlled electronic device for the measurement of turntable speeds (16-2/3, 33-1/3, and 45 rpm). A three-digit, seven-



segment readout enables the user to detect variations as low as  $\pm 0.01\%$  in turntable speed. It can be adapted to the measurement of tape recorder speeds, and can be used for continuous monitoring without interference to normal turntable or tape deck operation. Address: Woodard Electric, Inc., Box 1050, Hartselle, AL 35640.

# look up to Realistic®

You'll be surprised. Everything about the new Realistic Optimus® T-100 was designed with the discriminating music lover in mind. Tower design puts the speakers at perfect height, without special mounting or stands. Two active 8" acoustic suspension woofers and a 3" tweeter deliver sound so natural you can feel as well as hear its richness. Unlike many large high-performance speaker systems, the T-100 is efficient enough to be driven by almost any hi-fi equipment without pushing the amplifier, yet has the capacity to take 75-watt program peaks. The 3-ft. high, walnut veneer enclosure is finished on all sides to simplify placement and add fine furniture elegance. Sold only by Radio Shack. Ask for 40-2025 and find out what "towering sound" sounds like — today!

**139<sup>95</sup>\***

Smart styling that's practical, too

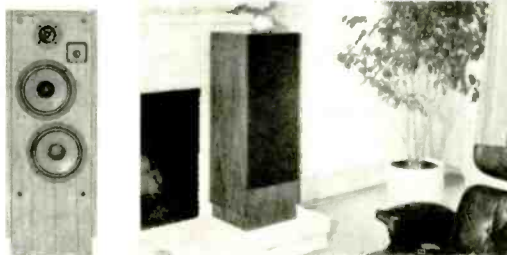

Grille removes for easy speaker balance adjustment

Bottom-mounted terminals — speaker cable remains out of sight

# Radio Shack®

A TANDY CORPORATION COMPANY

OVER 5000 LOCATIONS • 50 STATES • 9 COUNTRIES

\*Retail price may vary at individual stores and dealers.



**FREE!**

164-page 1977 catalog. Full color. See what's really new in electronics. Get your copy now at our store near you.

# YOUR FIRST MICROPROCESSOR KIT SHOULD BE COMPLETE, UNCOMPLICATED AND INEXPENSIVE.

## THAT'S WHY SCHWEBER OFFERS NATIONAL'S SC/MP KIT.

Nobody has to tell you that microprocessor technology is revolutionary. Trouble is, it's a development with such far-reaching implications, for science, for business, for you, that it can be a little intimidating.

That's why Schweber Electronics wants to introduce to you National's SC/MP microprocessor kit. It's the newest 8-bit, low-cost microprocessor system on the market.

SC/MP is ideal for use in those sophisticated calculators, electronic games, appliance controls, heating and security systems, and mobile communications units you'd like to design and build.

Schweber has the complete SC/MP Kit in stock right now. So, order yours today. Be the first to get the very capable, very economical SC/MP Kit from Schweber — a leader in microprocessor distribution.

### What your National SC/MP Kit from Schweber includes:

- The SC/MP MPU chip.
- Voltage Regulator.
- 256 Bytes of RAM.
- ROM with KITBUG Program.
- 8-Bit Data Buffer.
- 1-mHz Crystal.
- TTY Interface.

**Plus:** PC Board,  
Connector,  
Sockets,  
Resistors  
and Capacitors.

Mail coupon & check to:  
Schweber Mail Order Division  
P.O. Box #152  
Jericho, New York 11753

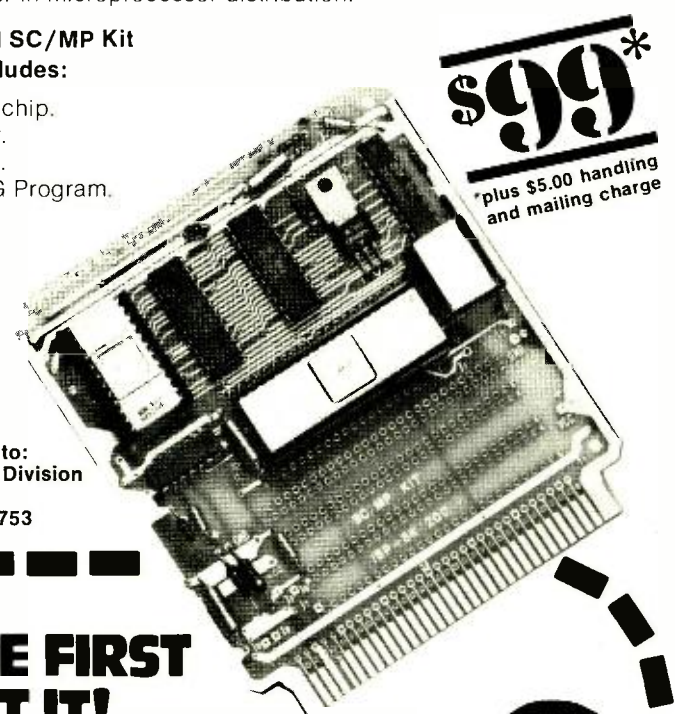

### BE THE FIRST TO GET IT!

Please send me \_\_\_\_\_ kits @ \$99.00 plus \$5.00 handling & mailing charges (add sales tax where applicable).

Name \_\_\_\_\_

Address \_\_\_\_\_

City \_\_\_\_\_ State \_\_\_\_\_ Zip \_\_\_\_\_

© 1976, SCHWEBER ELECTRONICS CORPORATION



**SCHWEBER  
ELECTRONICS**



## New Literature

### ELECTRONICS DESIGN AND TESTING

"59 Ways to Save Time and Money Designing and Testing in Electronics" is a new, 32-page, full-color, pocket-size catalog from Continental Specialties. Designed for electronics hobbyists, technicians and designers, the catalog features some of Continental Specialties' new items (a precision digital pulse generator, a selective-threshold test instrument that indicates logic status, and a circuit-powered, multi-function test tool with memory). There are also sections with helpful hints on the use of solderless breadboarding sockets and breadboards; a section on digital and linear breadboarding design and construction; and a block diagram and connection chart of the most popular digital IC's. Address: Continental Specialties Corp., 44 Kendall St., P.O. Box 1942, New Haven, CN 06509.

### ELECTRONIC CIRCUIT HARDWARE

AP Products announces its new 19-page booklet on state-of-the-art breadboarding and testing devices. Included are AP's All-Circuit Evaluator series, designed to give greater flexibility and reliability to circuit building; IC test clips; strips; breadboards; unicards; pc extender cards; tie-point blocks; accessories, patch cords; miniature 8-pin connectors; connector pins and sockets; male and female headers; and digital test probes. The catalog is fully illustrated and technical specifications, dimension and application information are provided. Address: AP Products, Inc., Box 110, 72 Corwin Dr., Painesville, OH 44077.

### CASSETTE TAPE BOOKLET

Fuji announces a new booklet, "Cassette Tape and How to Make it Work for You." Written on a nontechnical level, the booklet contains information on the selection and use of cassette recorders/players. It features a section describing the uses of cassettes as creative aides and explains the steps to take to ensure optimum results. Also included is a section on the language of cassette tapes, converting technical engineering language into understandable terms for consumers. Address: Fuji Photo Film U.S.A., Inc., Audio Tape Div., Empire State Building, New York, NY 10001.

### CB ACCESSORIES CATALOGS

Turner announces new catalogs for its Citizens Band products. A 12-page micro-POPULAR ELECTRONICS



# ROUGH RIDERS

Royce builds CB's that ride the roughest roads. Because one loose connection and your CB is 10-7—out of service. Building CB's that can hold up under the shock of road bumps and wide temperature extremes isn't easy. It takes more than care in construction. It takes advanced engineering design. That's what Royce gives you. We developed the modular printed circuit for CB's. Our modular units eliminate most of the wires normally found in CB's. By eliminating these wires, we've eliminated a major source of repair problems. Then, to make sure your Royce is working perfectly before you buy it, we electronically check every CB we build. And make sure each one is FCC-type accepted. Granted, it takes more time and know-how to build a Royce CB. But we feel the problem of keeping a CB working should be ours, not yours. That's why...

Everybody's talking 'bout

**Royce** 

©Royce Electronics Corp. 1976



Write for a free brochure to Royce Electronics Corp., 1746 Levee Road, North Kansas City, Missouri 64116

CIRCLE NO. 56 ON FREE INFORMATION CARD



## Revolutionary! Sound-shaping taping mike.

Never before — a single microphone that gives you the versatility of 16 microphones! Four tiny frequency filter switches built into the new Shure 516EQ E-Qualidyne Microphone let you tailor sound for studio effects in virtually any recording situation: flick a switch to add sizzle to vocals . . . flick another switch to highlight the sound of a bass drum. You can even compensate for the acoustic response of a room — *right from the microphone!* In all, the 516EQ creates 16 different response variations that can add a new, professional sound to every tape you make. Available singly or in pairs for stereo recording. Ask to hear a recorded demonstration at your participating Shure dealer.

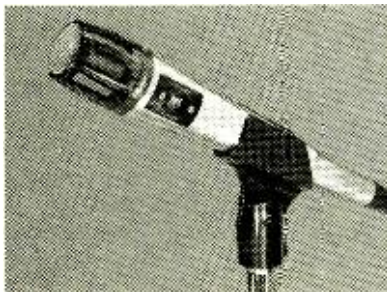

Shure Brothers Inc.  
222 Hartrey Ave., Evanston, IL 60204  
In Canada: A. C. Simmonds & Sons Limited



Manufacturers of high fidelity components, microphones, sound systems and related circuitry.

phone catalog features seven new products, including an amplified base-station mike with tone-control and voice-strength meter, and an amplifier mobile microphone that uses readily accessible 9-volt batteries. Also available is the new Signal Kicker antenna catalog, which has been expanded to 16 pages, including a section on recreational vehicle antennas. Address: Turner Division of Conrac Corp., 716 Oakland Rd. N.E., Cedar Rapids, IA 52402.

### 1976 SEMICONDUCTOR GUIDE

General Electric announces a new 200-page 1976 edition of its Semiconductor Guide, ETRM-4311. The revised and updated catalog cross-references GE universal replacement semiconductors and supplies application and technical data on the devices. Included are 52 new entertainment semiconductor devices for TV, FM and FM stereo applications, and information on five semiconductor kits, 19 experimenter/hobbyist components and 22 accessories such as transistor heat sinks, sockets and micas, and IC sockets. \$1.00. Address: General Electric, Suite 301, 2001 Gardiner Lane, Louisville, KY 40205.

### POLYPHONY

PAIA announces a new quarterly magazine "Polyphony." Directed toward the electronic music enthusiast, the publication intends to be an information exchange between the related fields of electronic theory and circuit design, music theory, acoustics and recording techniques. Containing reader contributions, PAIA staff material and new product information, the magazine combines the information into a usable format for electronic music applications. Current issue free upon request. Address: "Polyphony," % PAIA Electronics, Inc., 1020 W. Wilshire Blvd., Oklahoma City, OK 73116.

### CB CATALOG SERIES

A new, 11-page catalog from Shakespeare illustrates its line of citizens, marine and business band antennas with related mounts, hardware and test equipment. Included are fiberglass whip, base-loaded, top-loaded, co-phased, and new 2-foot stick mobile antennas; half-wave omnidirectional CB base station antennas including the first fiberglass directional antenna; vhf-FM and SSB marine antennas; and mobile, base station and ground plane business band antennas. A section on mobile CB mounts and accessories and marine accessories is also included. In addition, Shakespeare offers a series of illustrated minicatalogues, featuring CB mobile transceivers; CB antennas and accessories; and marine antennas and accessories. Address: Shakespeare Co., 2805 Millwood Ave., Columbia, SC 29205.



# afs® / Kriket® CB speaker Sound and Safe!



**kamel™**

Hump mount speaker

**Speakers are our only business.**

**They have to be better!**

Designed with security and superior sound in mind, the AFS / KRIKET KAMEL KC-3085 hump-mount external speaker rests snugly on the transmission hump while driving. CB dials are readily visible.

CB transceiver mounts on speaker base forming single unit. No installation problems. For maximum security, unplug antenna and power leads, lift unit and place in trunk. No screws to unscrew or hassle. No annoying rattles while driving. Solid!

"WORKING WALL" enclosure of cross laminated fiberboard deadens static and channel noise, eliminates voice distortion.

AFS makes having an expensive CB rig in your car or truck safe and worthwhile. Isn't it about time somebody did?

*Kriket Corp.*

Available at CB dealers everywhere



**ACOUSTIC FIBER SOUND SYSTEMS, INC.**  
7999 KNUE ROAD, SUITE 106 INDIANAPOLIS, INDIANA 46250 (71) 842-0620

Canadian Distributor Muntz Canada Ltd. 1149 Pioneer Road Burlington Ontario, Canada (416) 639-5373

All AFS®/KRIKET® speakers are manufactured in the U.S.A. using American materials and craftsmanship.

Copyright 1976 Acoustic Fiber Sound Systems, Inc.

[www.americanradiohistory.com](http://www.americanradiohistory.com)

# If you can't go to college for your career in electronics —read this!

**CREI brings college-level training to you with eight educational advantages, including special arrangements for engineering degrees**

The best way to qualify for top positions and top pay in electronics is obviously with college-level training. The person with such training usually steps more quickly into an engineering level position and is paid considerably more than the average technician who has been on the job several years.

A regular college engineering program, however, means several years of full-time resident training—and it often means waiting several years before *you can even start your career*. This, of course, is difficult if you must work full time to support yourself and your family.

If your career in electronics is limited without college-level training, take a look at the advantages a CREI home study program can offer you.

## **1. Convenient Training**

CREI brings the college to you. Through the convenience of home study, you receive exactly the same level of training you will find in any college or university offering programs in electronic engineering technology. With CREI, however, you can “go to college” whenever you have spare time at home or on the job.

## **2. Specialized Programs**

With CREI, you enjoy the advantage of *specialized* training. That is, your program will include only those courses directly applicable to your career in electronics. We omit such courses as English, social studies and other subjects, which are usually required in resident schools. Therefore, with CREI, you move ahead faster to the more interesting and useful part of your training.

## **3. Practical Engineering**

CREI programs give you a *practical engineering* knowledge of electronics. That is, each part of your training is planned for your “use on the job.” By using your training, you reinforce the learning process. And by demonstrating your increased knowledge to your employer, you may qualify for faster career advancement.

## **4. Engineering Degrees**

CREI offers you a number of special arrangements for earning engineering degrees at recognized colleges and universities. You can earn college credit while you are taking your CREI program or apply later, whatever is best for your career plans.

# Career Training at Home

## 5. Unique Laboratory

Only CREI offers you the unique Electronic Design Laboratory Program. This complete college laboratory makes learning advanced electronics easier and it gives you extensive practical experience in many areas of engineering, including design of electronic circuits. No other school offers this unique program. It is a better "Lab" than we have found in many colleges. And the professional equipment included in the program becomes yours to keep and use throughout your professional career.

## 6. Wide Program Choice

CREI gives you a choice of specialization in 14 areas of electronics. You can select exactly the area of electronics best for your career field. You can specialize in such areas as computer electronics, communications engineering, microwave, CATV, television (broadcast) engineering and many other areas of modern electronics.

## 7. Prepared by Experts

Experts in industry and technical organizations of government develop CREI programs. Each part of your training is developed by a recognized expert in that area of electronics. That means you get the most up-to-date and practical instruction for your career.

## 8. Industry Recognition

That CREI training is recognized by industry and government is evident from the fact CREI provides training to advanced technical personnel in over 1,700 technical organizations. Many subsidize the training of their employees with CREI. If there is any question about the advantages of CREI training for you, ask your employer or any engineer to evaluate the outline of a CREI program for you.

## Other Advantages

Of course, there are many other advantages to CREI training. For example, throughout your training, CREI's staff gives you personal instruction for each step of your program. And in many industrial areas, both in the U. S. and abroad, CREI Field Service Representatives provide a number of important personal services for your training and your career.

## FREE Book

There isn't room here to give you all of the facts about career opportunities in advanced electronics and how CREI prepares you for them. So we invite you to send for our free catalog (if you are qualified). This fully illustrated, 80 page catalog describes in detail the programs, equipment and services of CREI.

## Qualifications

You may be eligible to take a CREI college-level program in electronics if you are a high school graduate (or the true equivalent) and have previous training or experience in electronics. Program arrangements are available depending upon whether you have extensive or minimum experience in electronics.

Send for this **FREE Book** describing your opportunities and CREI college-level programs in electronics



Mail card or write describing qualifications to

**CREI** **CAPITOL  
RADIO  
ENGINEERING  
INSTITUTE**

McGraw-Hill Continuing Education Center  
3939 Wisconsin Avenue Northwest  
Washington, D.C. 20016

Accredited Member National Home Study Council

## GI Bill

*CREI programs are approved for training of veterans and servicemen under the G.I. Bill.*





# Stereo Scene

By Ralph Hodges

## CONSUMER ELECTRONICS SHOW—SUMMER 1976

**T**HIS YEAR'S SUMMER Consumer Electronics Show was orderly and level-headed. Among the majors—Pioneer, Marantz, Kenwood, Sansui, etc.—there were precious few introductions of top-of-the-line models, but there were scads of lower-price components to continue a series begun last year with one or two "flagship" products. This was especially true for receivers and integrated amplifiers, and even for some preamplifiers and power amplifiers. For example, Yamaha's premier introduction was the Model B-2 at 100 watts per channel. It is a V-FET power amplifier cast from the mold of the more powerful B-1. The Luxman 5M21, with the same power rating, is obviously a descendent of that company's larger power amplifiers. In addition, both manufacturers introduced companion preamplifiers at lower prices than heretofore.

**Trends & Themes.** It was a banner show for direct-drive turntables—to the point where it is a rare major turntable line that does not include at least one. The elite among the direct-drives now derive their reference frequencies from quartz-crystal oscillators, and their servos employ phase-locked loops. Technics, JVC, and Sansui all had brand-new machines with these features at CES.

Apparently the market for three-head cassette decks is suddenly coming to life once again. It seems that a

serious tape-alignment problem has balked the widespread availability of such machines up to now. The problem has been that any significant spacing between the record and playback heads gives the cassette's relatively crude tape-guidance system ample chance to skew the tape. And since no cassette is (in theory) exactly like any other, there was no predicting what sort of azimuth error the skew would introduce. Even turning a cassette over to use its other side would often significantly alter the alignment.

The Models 1000 and 700 from Nakamichi, now a few years old, incorporated the first practical remedy for this state of affairs: an alignment "beacon" system that enabled one to reset the azimuth of the record head quickly and unambiguously for each cassette side. Then, last year, Hitachi presented a deck, the D/3500, with a wholly new approach—record and play heads that snuggled against each other so closely that any tape skew within the short space separating the two sets of gaps was a scant possibility. In fact, the gaps were so close they could even share the cassette's single pressure pad. Apparently, this innovation lent impetus to other cassette-deck manufacturers who had thought that azimuth adjustments were a bit too arcane and expensive to attract an appreciable market. Fisher acted first, and now has three models employing this scheme. Akai has used it for its new GXC-570D, among other machines. And now this year, Teac has adopted it for its long-anticipated three-header, the 860, which will head the company's brand new "Esoteric" series. In place of azimuth adjustments, the 860 has continuously variable bias and equalization controls on its front panel, as well as elaborate mixing facilities.

A few manufacturers have elected to stick with separate, spaced record and playback heads. Among them are

Tandberg, whose new TCD 330 has a record-head azimuth adjustment with a meter to indicate correct alignment. The Lenco C-2003 also has spaced heads, but seems to lack any special alignment features.

In the world of loudspeakers, the CES brought a small inundation of products designed to be phase-coherent, following the lead provided (in their various manners) by Ohm, Dahlquist, and B & O. The most popular approach is obviously the staggered-array configuration. In other words, if the tweeter is a little "faster" than the woofer in getting off the mark, simply locate the tweeter's diaphragm a little farther from the listener to even things out. This results in staggered drivers, each occupying its own mounting plane. The B & W DM6 from England is a good example, as is a new floor-standing system from Eng-

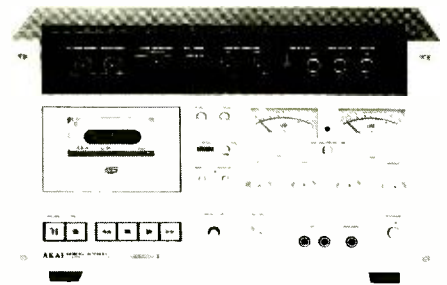

*Akai GXC-570D cassette deck.*

land's KEF. From the U.S., the Audioanalyst "Anthem Array," the Jennings Research Contrara Vector One, and the Paradox TA-12 "Time Align" (highly reminiscent of the B & W product in its appearance) are all adherents of this philosophy. Even Japan demonstrated interest via the "Professional Series" from Technics by Panasonic. The top-of-the-series model, the SC-9000, is truly a sight to behold, with four large woofers and three enormous mid- and high-frequency horns, looking powerful enough to be lethal to houseflies and other frail life forms.

**New amps or old?** You've probably noticed a trend to Class A amplifiers from some manufacturers of the more esoteric electronic products. This was continued by new CES products from Stax, Mark Levinson, and some other lesser-known companies. The claimed benefits and the performance of such devices have been tempting to consumers and other manufacturers alike. However, the reduced gain and comparative inefficiency of Class-A

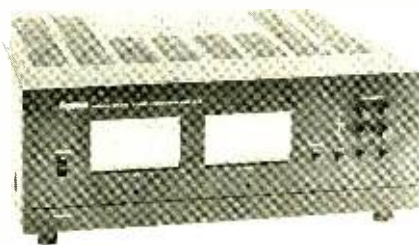

*Yamaha B-2 power amplifier.*



TC-800GL

HP-1

# Form follows function.

At Yamaha, it's been that way since 1887, when we began making music by making the finest musical instruments in the world.

Today, the same advanced technology found in our musical instruments has made Yamaha a leader in state-of-the-art audio components.

For example, we engineered our innovative Orthodynamic HP-1 and HP-2 stereo headphones to give both the smooth, crisp highs of the best electrostatic headphones and the rich, clean bass of the best dynamic types at a surprisingly low price.

But it wasn't enough to make them the best sounding headphones ever heard. We consulted world-famous designer Mario Bellini to help us make them the most comfortable headphones ever worn. Because we knew if they were uncomfortable, you wouldn't put up with them.

That's why a soft strap distributes the featherlight weight of the HP-1 and HP-2 evenly over your head. Special foam ear pads form a supple, compliant seal. Height and angle are completely adjustable to your head.

Yamaha musical technology is also highlighted in our superlative TC-800GL and TC-800D stereo cassette decks, offering cassette convenience with performance rivaling that of some of the finest open reel decks.

To satisfy the most sophisticated recordist, both the TC-800GL and TC-800D offer incredibly low 0.06% wow-and-flutter, Dolby\* Noise Reduction, and Variable Pitch Control. (The TC-800GL can even be used for remote recording.) But, if

you don't like to do a lot of fiddling around, both models offer automatic convenience features like Auto Timer Start, Auto Stop, Auto Memory Rewind, and Auto Switching for CrO<sub>2</sub> tape.

Also showing Mr. Bellini's touch, the functional wedge styling and stepped controls of these cassette decks give you easy control and visibility from any standing, sitting, or reclining position.

If you'd like a closer look at some other examples of form following function, send for our free catalog of stereo components. Or see your local Yamaha Audio Specialty Dealer. You'll get a lot more than just a demonstration.

\*Dolby is a registered trademark of Dolby Laboratories, Inc.

Yamaha International Corporation 101  
Audio Division, P.O. Box 6600, Buena Park, Calif. 90622

Please send my free copy of the Yamaha stereo components catalog and a list of Yamaha Audio Specialty Dealers.

Name \_\_\_\_\_

Address \_\_\_\_\_

City \_\_\_\_\_

State \_\_\_\_\_ Zip \_\_\_\_\_



operation have made the whole idea seem impractical in a power-competitive market. Class AB or something close to it has therefore remained supreme up to now. But CES gave evidence that some designers are out to get the best of both worlds.

In the SR/903 receiver, Hitachi presented the first example I have personally encountered of a Class-G amplifier. Briefly, the equivalent of two



*Hitachi SR 903 receiver.*

push-pull output sections is employed. One handles small amplitude signals and the other is switched in for large transients. If I understand the whole business correctly (details were still sketchy at show-time), the two sections are biased differently, enabling the low-output section to approach Class-A operation, and the high-output section to operate in a very efficient mode. The idea recalls to mind the Sharma circuit from the Mattes amplifier of the mid 60's, although the actual configuration of the circuit is, of course, different. At 75 watts per channel continuous, the Hitachi receiver is not a powerhouse by today's standards, but the power it does have comes in a competitively sized and priced package, with some intriguing technical features.

The Nakamichi 620, a 100-watt-per-channel power amplifier, is said to operate—I am tempted to say “nominally” operate—in the Class-B mode. Of course Class B, efficient though it is, can be beset by crossover distortion and other troubles if the designer is not very careful. But this amplifier has a 0.005 percent *guaranteed* distortion level. Apparently (again details were few at the moment of writing) the nastinesses of Class B have been cured by a carefully designed bias-control circuit. In any case, the 620 is certainly compact enough to support its claims for highly efficient operation and only two transistors per channel are used in the output stage. Another amplifier introduced at the show, the

Audionics PZ3, is also said to use a bias-shifting control circuit.

**The Elcaset.** CES served as the official debut arena of the Elcaset format, for which its co-developers, Matsushita (Panasonic and Technics), Sony, and Teac, have high hopes. The Elcaset principally differs from the Philips cassette in being considerably larger, using ¼-inch tape and a 3¾-ips tape speed. Also, it does not depend

on the cassette package itself to provide tape guidance. Instead, the tape is drawn out of the cassette in the form of a loop, so that the machine's internal guides and tensioners are solely responsible for its transport and alignment.

In these respects, the Elcaset resembles the BASF Unisette announced last year, but as yet not really seen in this country. However, while the Unisette envisioned professional users, the Elcaset is intended as a consumer product.

The CES brought forth four machines that can record and play Elcaset: the Sony EL-7 and EL-5, a deluxe Technics, and a Teac prototype. The Sony decks were three-head three-motor (the EL-7) and two-head single-motor (the EL-5). The Technics extravaganza had four direct-drive motors (two in the dual-capstan tape-drive system) and four heads (the fourth for the narrow control tracks for



*Teac 860 cassette deck.*

which room is provided in the center of the Elcaset tape).

No one doubts that the Elcaset format can measurably outperform the Philips cassette. But the big question being asked is: Will this measurable superiority translate to a significant *audible* superiority? In other words, is it possible that the Philips cassette format, over its years of refinement, has become good enough to compete with any other high-fidelity program source—the Elcaset and even high-speed open-reel—for certain types of program material? And if it hasn't, isn't it likely to in the near future, obviating the need for another quality tape cassette format at this time?

The coming months should yield some answers to these questions. In the meantime, it is true that the Elcaset doesn't face the restrictions on four-channel that have troubled the Philips cassette. But if this is to be a factor, we then have to ask whether the apparently waning interest in quadraphonics will justify any manufacturer's offering a four-channel Elcaset machine.

A final question being asked about the Elcaset format concerns the tape itself. Who is going to be supplying Elcaset, and in what form? Sony is into production already, of course, and will be offering a low-noise tape



*Luxman 5M21 power amplifier.*

formulation as well as Ferrichrome (the first ¼-inch Ferrichrome tape to appear on the market). The positions of the other tape manufacturers have not been clarified, however. Another matter: the Technics machine has switch positions for chromium-dioxide bias and equalization, although Sony has not announced a chromium-dioxide Elcaset and at the moment there seems to be some doubt whether it will. To what extent might the Elcaset format get embroiled in the chrome-vs.-ferric debate that is being waged rather briskly right now?

Whatever happens, the Elcaset promises to be a superb if rather expensive tape medium. But certainly it will not be beloved by all. Some manufacturers are talking about serious ventures into microcassettes. If they make a move, things should really be jumping by this time next year. ♦

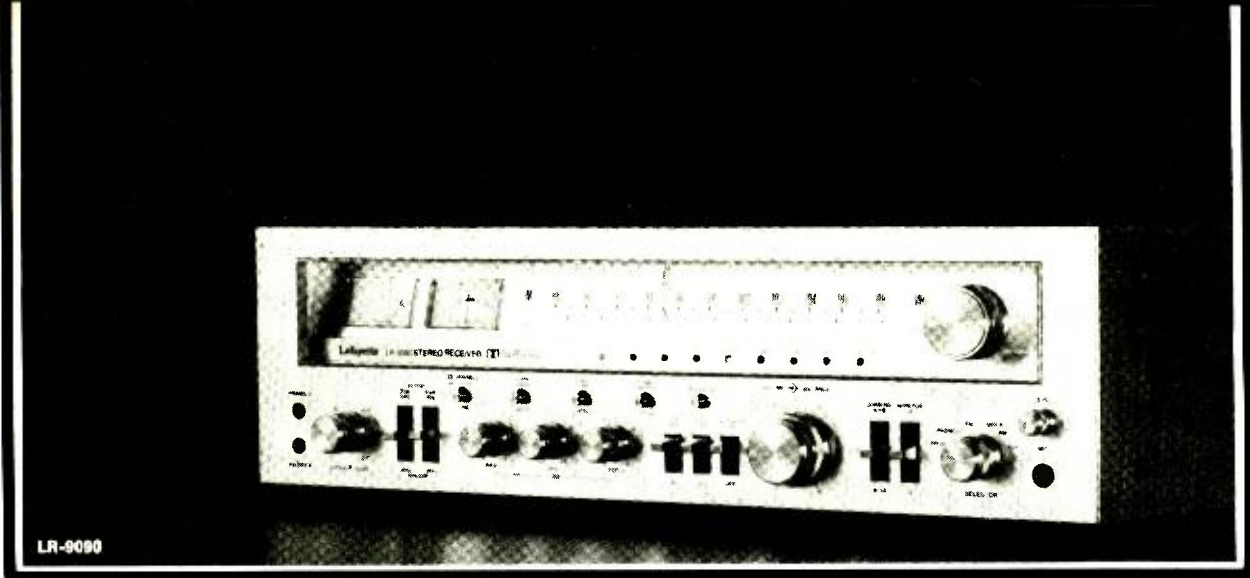

# The new Powerhouse line. It's only competition is on this page.

No one can compete with Lafayette's new Powerhouse line of receivers.

And the top of the Powerhouse line is the best yet. Check the spec chart. Compare it to what you're listening to now. And to what the competition is offering. You'll see the Powerhouse line delivers.

The two top of the line receivers have features you've never had on any receiver before. Advanced features like Dolby® FM noise reduction system (on the LR-9090) and a mike mixing feature on both models. Even features like mid-range frequency emphasis and tape dubbing controls are included

for your control of the sound. And they share many of the features of the line like digital phase-lock-loop circuitry, positive detent controls and convenient push/lock speaker terminals.

If the competition could give you all these features they still couldn't deliver extras like Lafayette's protective warranties, and audio experts who care about you. Stop in at one of the Lafayette dealers or stores coast to coast.

You'll see the only competition for Powerhouse features and performance is another Powerhouse receiver.

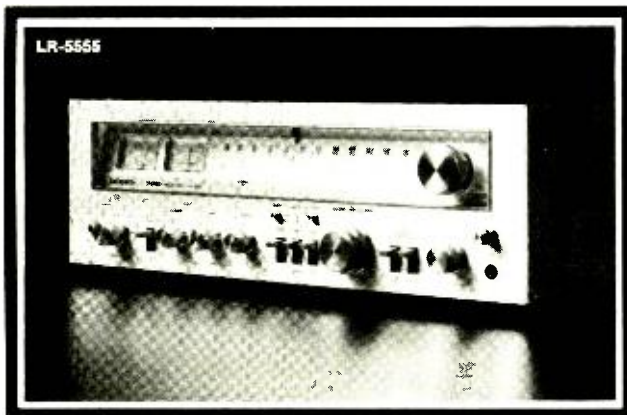

Specifications	LR-9090	LR-5555
Power Min. RMS 20-20,000 Hz	90 - 90	55 - 55
Total Harmonic Distortion(Less Than)	0.1%	0.5%
Input Sensitivity: Phono/Aux/Mike mV	2.5/150/6	2.5/150/6
Tone	Bass/Mid/Treble	Bass/Mid/Treble
Speakers	A, B, C	A, B, C
FM Sensivity (Stereo)	21.0 dBf (1.8 $\mu$ V)**	21.0 dBf (1.8 $\mu$ V)**
Selectivity	80 dB	80 dB
Capture Ratio	1.25 dB	1.25 dB
Price	\$599.95	\$399.95

\* @ 40-20,000 Hz  
\*\* IHF ('58) Sensitivity (Mono)

# Lafayette

There is no competition.

For more information and a free catalog please write: Lafayette Radio Electronics, Box 122, 111 Jericho Tpke., Syosset, N.Y. 11791  
Copyright 1976 Lafayette Radio Electronics

# NEWS HIGHLIGHTS

## CB Channel Expansion, Etc.

The FCC will add 17 AM voice channels to the present 23 on the 27-MHz CB radio band, effective January 1, 1977. Technical specification requirements will change, too, with spurious response requirements more stringent. Receivers with 40 voice-communication channels won't be available very soon, however, since the equipment must be type accepted by the FCC (which recently rejected 25 applications for certification of 23-channel rigs). Then there are production and distribution to be taken care of. Moreover, there won't be many people to talk to on the 17 new channels for some time to come. Additionally, truckers are expected to continue to use Channel 19, while Channel 9 will remain as the emergency/assist channel. So the 23-channel CB transceiver promises to be with us for some time, just as vhf television hasn't been supplanted by the addition of uhf stations.

Among other rulings, Channel 11 is no longer the CB "calling channel." It will be used just as other allocated frequencies (except Channel 9, of course). And CB'ers will not be able to blithely ignore harmonic interference to a neighbor's television receiver (Channels 2, 5 or 6) due to insufficient harmonic suppression. The license causing the interference is now directed to insert a low-pass filter between his r-f output connector and the antenna feedline. Furthermore, a host of proposed changes were shot down. For example, the present 27-MHz Class C radio control frequencies will not be reallocated to the Class D band, although the FCC indicated that alternate frequencies must be found at some time due to the problem of interference to Class C operations. Also, a proposal to lower the age requirement for a Class D station license from 18 to 16 has been turned down for now.

## Test Cassette Series

A new series of cassette tapes for test purposes has been introduced by TDK. The "AC" series consists of 12 cassettes for testing crosstalk, recording calibration, head alignment, frequency characteristics, wow and flutter, tape speed, and playback calibration with and without Dolby. Cassettes range in price from \$10 to \$35 each.

## Needle-Fine Solder

Solder with 5 rosin cores, capable of fitting through the eye of a needle (a one-pound reel of 34 SWG is nearly one mile long), has been developed by Multicore Solders of Westbury, New York. Designed for integrated circuit, miniature component and micro-electronic applications, the extremely fine solder makes it easier to control the placement, amount and speed of soldering.

## Video Game Chip Shortage

The rising demand for home video game IC's and MPU's was evident this year at the Summer Consumer Electronics Show, where a number of toy manufacturers and electronics companies displayed their games. It's estimated that the total number of video games sold this year will range from two to five million. Most suppliers expect, however, that the demand will continue to outstep the supplies, pushing manufacturers farther back in their delivery schedules. Though the parts shortage is expected to be temporary, supplies promise to be tight through the pre-Christmas season.

## Computers At Golf Classic

For the first time, the R and A Golf Club of St. Andrews, Scotland employed computer terminals to improve spectator information on scores at the 105th British Open Championship held in Southport, England this summer. The terminals, supplied by Sperry Univac, automatically relayed scoring information throughout the club for printout and scoreboard posting. Ultimately, the goal of the R and A Club is to use a computer which can provide detailed information on the progress of the championship tourneys, as well as historical statistics and analyses of the players' performances hole-by-hole.

## AM Stereo Broadcasts

Kahn Communications, Inc. has filed a petition with the FCC to institute proceedings for a change in regulations which would allow AM broadcasters to operate stereophonically. The petition stresses that the system is compatible with standard AM broadcasting, that it covers large reception areas, and does not contain the noise bursts found in FM stereo automobile reception, and that many listeners already own radios that can receive the AM stereo signal. Reports have been submitted to the FCC by WFBR, Baltimore and XETRA, Tijuana, Mexico concerning on-the-air experiments that have been made over a total of three and a half years.

## PSB Frequency Assistance

To help owners of vhf/FM monitors and scanners learn which frequencies are used in their reception areas, the Electra Company has established a Frequency Assistance telephone line to serve their customers in most areas of the U.S. It's open each working day from 8 a.m. to 5 p.m., and can be reached by calling, toll free, 800-428-2326 (in Indiana 800-382-2072).





# Shakespeare welcomes you aboard.

You put a CB radio in your car, truck or camper for a reason. To know what's happening on the highway. And Shakespeare teams power and performance in CB radio to give you the ultimate control over what you need to know.

Punching signals through loud and clear. For emergencies. For directions. Or just for fun.

The same rugged reliability that has set Shakespeare marine gear in a class by itself stands beside every Shakespeare CB radio.

Shakespeare CE units are a cut above the ordinary. Engineered better to be the best.

And capable of enduring mile after mile of challenge on the open road.

Shakespeare's mighty serious when it comes to electronic communications equipment. And you've chosen the best.

Less than \$140.



#### Shakespeare GBS/1500

This compact low cost unit is designed for easy installation and is the perfect traveling companion. For long and short trips — monitor road conditions — check on safe anchorages, advise family of your arrival time.

The GBS/1500 solid-state transceiver utilizes Shakespeare's advanced circuitry and design to assure optimum clarity with reduced interference.

*Shakespeare*

**Sea tough. Highway dependable.**

Shakespeare Electronics Group, P.O. Box 246, Columbia, S.C. 29202 USA

# Switch to the CB antenna that beats the Citizens Bandits.

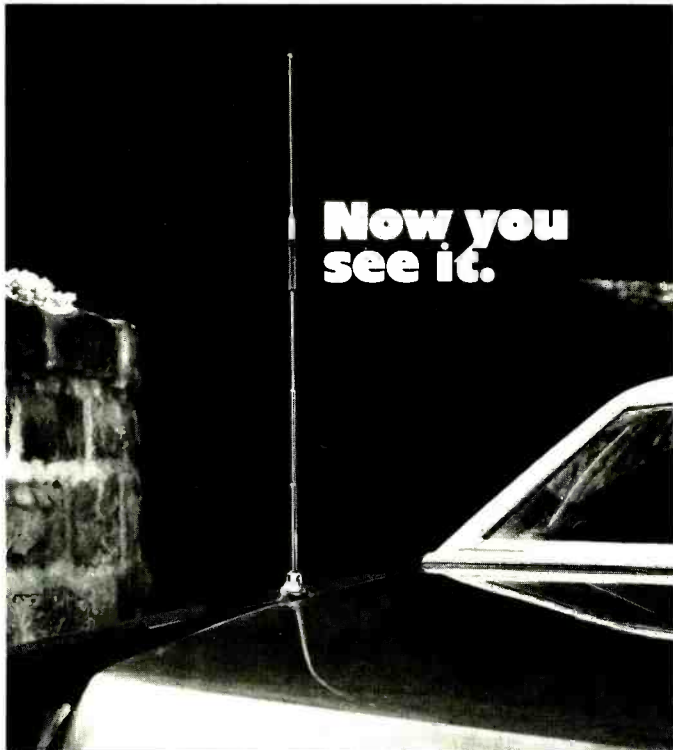

**Now you  
see it.**



**Now they  
don't.**

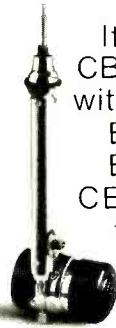

It's no wonder people are worried about CB thefts. All a thief has to do is spot a car with a CB antenna and he has his target. But he can't spot ours.

Because the TennaPower Disappearing CB Electric Antenna hides inside the fender when it isn't being used.

But there's no hiding from it when it's up. Because it performs like gangbusters.

One flick of the switch extends it fully or drops it out of sight. And even turns your transceiver's power on or off, automatically, at the same time.

Our antenna is center-loaded for better range. Its unique "skinny" coil disappears into the fender. Our motor is lifetime lubricated. Our materials are virtually corrosion-proof. And the antenna is designed to obtain an optimum SWR of 1.5:1 or better.

And our Disappearing CB Electric Antenna gives you this big, exclusive advantage: it's made by Tenna. We're the world leader in electric car antennas. Because we've built over 5 million disappearing electric car radio antennas for GM, Ford, Chrysler and Rolls Royce.

So buy the TennaPower Disappearing CB Electric Antenna at a dealer near you who sells CB or car stereo. You can ask him about installation or you may want to do it yourself.

Then beat the Citizens Bandits with the CB antenna thieves can't see. We think you can see why.

**Tenna  
Corporation**   
Cleveland, Ohio 44128

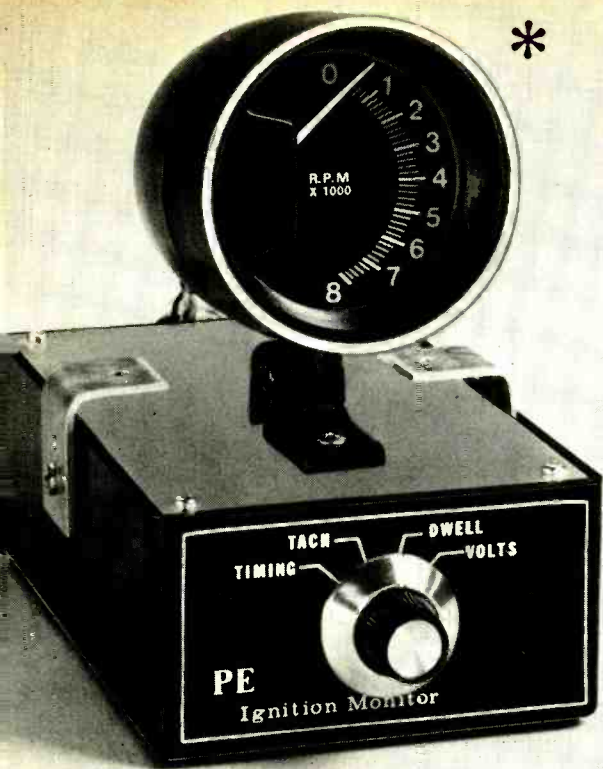

# Build a CAR IGNITION MONITOR

*Provides a visual indication of timing angle, rpm, dwell, and system dc voltage while you drive.*

BY WALTER B. HENRY

**W**ITH THE high cost of gasoline and annual increases in new car prices, it is becoming increasingly more important to keep our cars in perfect tune for maximum economy and engine life. Unfortunately, most of us put off periodic checks until our cars get "sick" and force us to do something about them. Hence, what every car needs is a device that keeps tabs on ignition performance at all times and provides a warning of potential problems before the car breaks down. This is exactly what the full-time Ignition Monitor described here is designed to do.

The Ignition Monitor lets you make all the common ignition system checks simply by flipping a switch and glancing at a meter. The parameters the system is designed to check include: ignition timing angle in degrees BTC, rpm, dwell angle, and electrical system voltage. The monitor can be permanently mounted in your car so that these parameters can be checked under all driving conditions—not just at idle. It can also be built into a hand-held case for tuning other cars equipped with the necessary sensor.

The system can be used with any 4-, 6-, or 8-cylinder engine equipped with either conventional (Kettering) or electronic ignition systems with breaker-point, magnetic, or optical switching. It can even be used with most magneto systems. An inexpensive accessory tachometer is used as

*\*Tachometer is not included in kit given in Parts List.*

the system's parameter indicator, while the electronics package is housed in a separate box that mounts under the dashboard.

Once your car is properly tuned and the Ignition Monitor is installed, you will soon get a "feel" for detecting even subtle changes in ignition operation. By monitoring the timing meter and driving for maximum advance, you can stretch your gas mileage and begin to economize immediately.

**How It Works.** The timing circuit of the ignition monitor utilizes an infrared LED/phototransistor optoelectronic sensor that senses a reference position of the engine's crankshaft. The sensor mounts close to the front pulley, or harmonic balancer. Once each crankshaft revolution a small metal "flag" attached to the pulley passes through the sensor and interrupts the infrared beam. This generates a signal that precisely indicates the position of the crankshaft.

In the circuit shown in Fig. 1, IC1A forms a flip-flop. Interruption of crankshaft sensor current causes the flip-flop to turn on. The subsequent arrival of an ignition pulse from the distributor terminal of the car's ignition coil triggers the shaping circuit made up of IC1B. The shaper output then turns off the flip-flop via D6 and resistor R28.

The output of the flip-flop is a series of pulses with a duty cycle that is inversely proportional to the timing angle. A smoothing circuit made up of

IC1C conditions the pulse train to drive the meter movement.

Most conventional and transistorized ignition systems have an initial positive pulse from the coil. This positive signal is routed to the IC1B shaper through a jumper in the IC1B input circuit. Most capacitive-discharge systems have an initial negative pulse output, which is routed through the C.D. side of the jumper.

The tachometer circuit uses a one-shot multivibrator circuit formed by IC1D. The constant-width pulse output from this stage has a duty cycle that is directly proportional to engine speed. The pulse output is smoothed by the inertia of the meter movement. Transistor Q1 delivers a pulse output whose duty cycle is proportional to the dwell angle. A 10-volt zener diode, D1, allows the meter to function as an expanded-scale volt-meter that registers potentials greater than 10 volts. Any potential less than 10 volts will not register on the meter.

**Construction.** You can assemble the entire circuit on perforated board or on a printed circuit board, the actual-size etching and drilling guide and components-placement diagram for which are shown in Fig. 2. There are two sets of connections to the circuit board. One set is via terminal strip TS1, which is for making connections to the car's ignition coil and electrical system, the sensor, and the meter. The other connections come from mode switch S1. the circuit board assembly

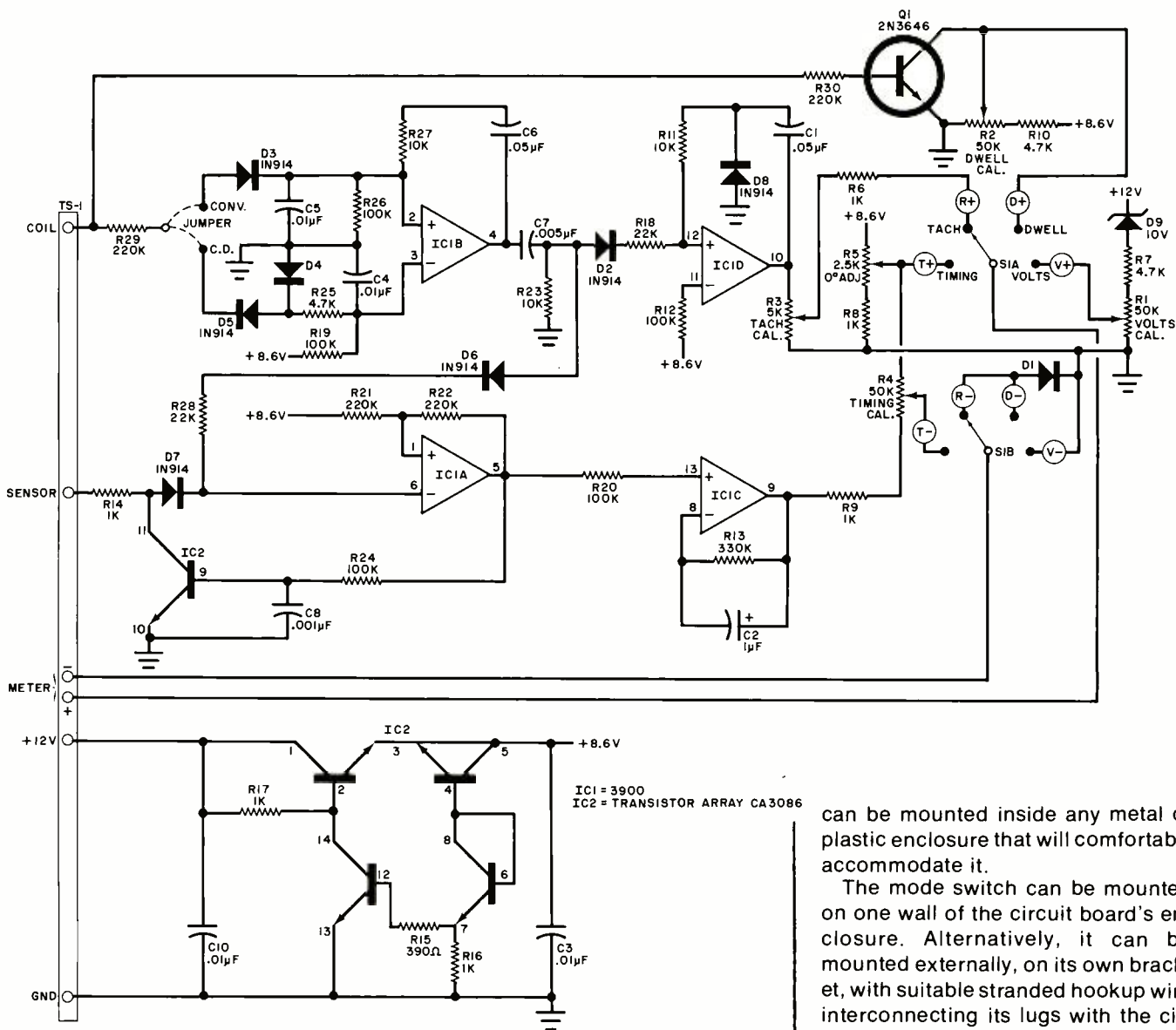

### PARTS LIST

C1, C6—0.05- $\mu$ F, 100-V disc capacitor  
 C2—1- $\mu$ F, 10-V electrolytic capacitor  
 C3, C4, C5, C10—0.01- $\mu$ F, 100-V disc capacitor  
 C7—0.005- $\mu$ F, 100-V disc capacitor  
 C8—0.001- $\mu$ F, 100-V disc capacitor  
 C9—Not used  
 D1 through D8—IN914 diode  
 D9—IN758 10-volt zener diode  
 IC1—CA3401, LM3900N, or MC3401P quad operational amplifier  
 IC2—CA3046, CA3086, LM3046, or LM3086 transistor array  
 Q1—2N3646 transistor  
 R1, R2, R4—50,000-ohm upright pc-type trimmer potentiometer  
 R3—5000-ohm upright pc-type trimmer potentiometer  
 R5—2500-ohm upright pc-type trimmer potentiometer  
 The following resistors 1/4-watt, 10% tolerance:  
 R6, R8, R9, R14, R16, R17—1000 ohms  
 R7, R10, R25—4700 ohms

R11, R27—10,000 ohms  
 R12, R19, R20, R23, R24, R26—100,000 ohms  
 R13—330,000 ohms  
 R15—390 ohms  
 R18, R28—22,000 ohms  
 R21, R22, R29, R30—220,000 ohms  
 R31—680 ohms  
 S1—Two-pole, four-position nonshorting rotary switch  
 Sensor—GE Photo-coupled H13A1 or H13A2 module  
 TS1—Six-lug screw-type terminal strip  
 Misc.—Suitable metal enclosure (see text); control knob; tachometer (see text); stranded hookup wire for interconnections; metal shim stock for flag (see text); epoxy cement; spacers; machine hardware; solder; etc.  
 Note: The following items are available from Kingston Instruments, 3805 Ashford Ave., Fort Worth, TX 76133: Etched and drilled printed circuit board for \$5.50; pc board with components and sensor for \$21.50; complete kit except for tachometer for \$26.50; sensor for \$3.00. Texas residents, please add 5% tax.

can be mounted inside any metal or plastic enclosure that will comfortably accommodate it.

The mode switch can be mounted on one wall of the circuit board's enclosure. Alternatively, it can be mounted externally, on its own bracket, with suitable stranded hookup wire interconnecting its lugs with the circuit board assembly.

Almost any electronic tachometer can be used for the display. The only requirement is that the meter movement can be driven to full-scale with 1 mA or less current. If the tachometer you buy has an electronic circuit in it, disconnect the circuit from the meter movement. Then solder a length of red stranded hookup wire to the movement's + terminal and a length of black stranded wire to the - terminal. Reassemble the tach's case, and terminate the free ends of the wires to the terminals labelled + (red) and (black) METER on TS1.

Different tachometer scales can be used in this application. For example, if you buy a tach with a 0-to-6000-rpm scale, it can indicate timing from 0° to 60° BTC, dwell from 0° to 60°, and voltage from 10 to 16 volts. A 0-to-8000-rpm tach will yield top-end figures of 80° BTC, 80°, and 18 volts, respectively.

The sensor must be mounted close  
**POPULAR ELECTRONICS**

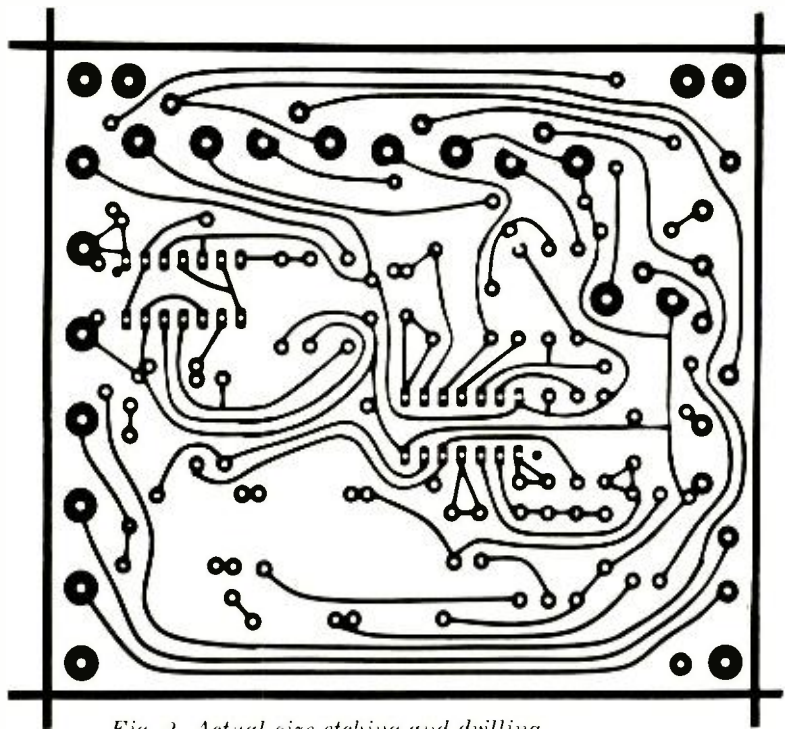
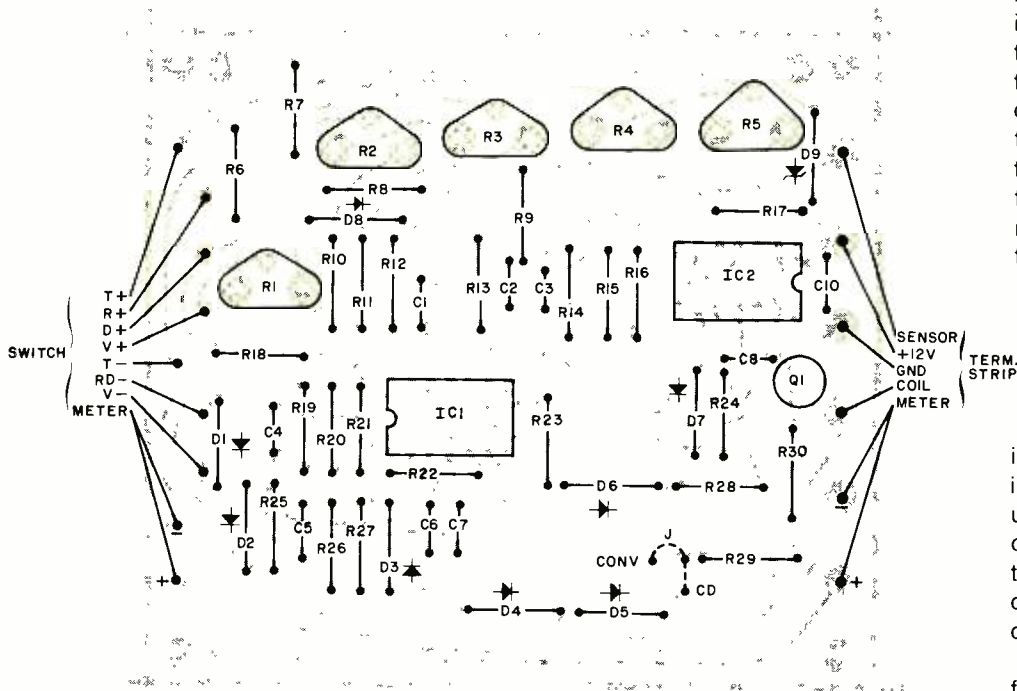

Fig. 2. Actual-size etching and drilling guide (above) and component placement guide (below) for printed circuit board.



to the front engine pulley, or harmonic balancer, as shown in Fig. 3. Fabricate a stiff metal bracket that will support the sensor with its gap facing toward and about  $\frac{1}{4}$ " (6.4 mm) away from the pulley's rim. This mounting bracket can be mounted as required on a water-pump bolt, pan bolt, or any other rigid mounting point near the pulley. Make the mounting bracket as short and stiff as possible to eliminate any vibration. Then route the three sensor leads away from any hot areas

in the engine well and pass them through the firewall at a point near where the circuit board assembly's enclosure will be mounted inside the passenger compartment.

The sensor flag can be fabricated from thin aluminum or brass shim stock trimmed to about  $\frac{5}{8}$ "  $\times$   $\frac{3}{16}$ " to  $\frac{1}{4}$ " (15.9  $\times$  4.8 to 6.4 mm). Normally, about  $\frac{1}{4}$ " of the flag's length will be glued to the rim of the pulley, leaving about  $\frac{3}{8}$ " (9.5 mm) of its length protruding beyond the rim to pass through the

sensor's gap once with each revolution of the crankshaft. Anchor the flag to the pulley with epoxy or any other strong water- and oil-resistant cement.

To properly position the flag on the pulley, refer to Fig. 4 and use a large wrench to turn the engine so that the timing mark on the pulley exactly lines up with the 0° timing point. Measure as closely as possible a 73° angle from the sensor in the direction of pulley rotation and attach the flag at this point. (Alternatively, use the wrench to pull the engine through 73° against the direction of rotation and cement the flag so that it is centered in the gap of the sensor.) The angle can be measured with a protractor. Another way to measure the angle is to measure the circumference of the pulley, divide by five, and with the engine on the 0° mark measure the calculated distance from the sensor to the flag position. The angle is not critical, but it must fall between 68° and 78°.

**Installation & Adjustments.** The installation wiring of the system is detailed in Fig. 5. In conventional ignition systems, the coil lead goes to the distributor terminal. In electronic systems, it may be necessary to try both terminals to locate the "hot" one. (In factory-installed systems, it may be necessary to consult a service manual to determine the proper hookup point

if the coil is contained in a module or in the distributor assembly.) Do NOT under any circumstances connect the coil lead to the high-tension (spark) terminal of the coil; if you do, you will destroy the monitor and introduce a dangerous shock hazard.

Route the coil lead through the firewall, spacing it a few inches away from the bundled sensor leads to avoid having noise pulses causing erratic operation. Then wire in a ground lead and a separate +12-volt supply lead. The +12-volt line should go to a source in the car's electrical system that is live when cranking the engine but off when the ignition is switched off.

Connect the meter and power leads to the electronics package. For now, leave the sensor and coil leads unconnected. Also, leave the electronics subassembly box unmounted so that

the trimmer potentiometers are easily accessible.

Five adjustments are required for accurate operation of the Ignition Monitor. You will need a voltmeter, tachometer, and timing light. (For a 4-cylinder engine, you will also need a dwell-meter.) Make the adjustments according to the following sequence:

1. Set all trimmer potentiometers to midrange. Connect the meter and the power leads to the electronics box but leave the sensor and coil wires unconnected. Do not start the engine yet.

2. Set the mode switch to VOLTS. Use the voltmeter to measure the vehicle's supply voltage and adjust VOLTS CAL pot *R1* to obtain an identical

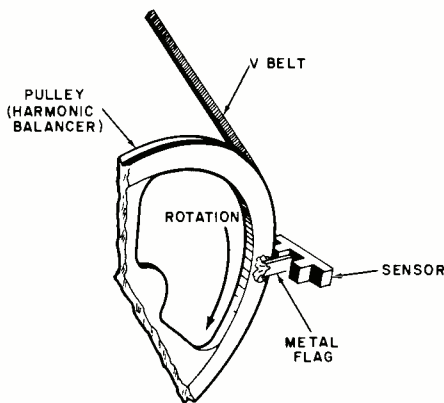

Fig. 3. Metal flag,  $\frac{3}{8}$  in. by  $\frac{1}{4}$  in. is attached to rim of harmonic balancer pulley to pass through slot in sensor interrupting light beam.

reading on the monitor's tach meter. Bear in mind that only potentials that exceed 10 volts will be indicated on the tach meter. (If the meter's pointer swings below the zero index, reverse the meter leads.)

3. Set the mode switch to DWELL. For an 8-cylinder engine, adjust DWELL CAL pot *R2* for a 45° reading; for a 6-cylinder engine, adjust for a 60° reading. For 4-cylinder engines, the adjustment must be made by comparison with a dwell-meter with the engine running. The correct reading here would be 90°, but most tachs will not have scales calibrated up to 9. Therefore, complete step 4 before making the 4-cylinder dwell adjustment.

4. Connect the reference tachometer and the coil lead to *TS1* and start the engine. For a 4-cylinder engine, connect the reference dwellmeter and adjust for an identical dwell reading. Set the mode switch to TACH and adjust TACH CAL pot *R3* for an identical

rpm reading. Check the calibration at various engine speeds. (Note: Accidental connection of the coil lead to the sensor input terminal may damage the IC's if the engine is started.)

5. Stop the engine. Connect the timing light and hook up the sensor leads to the monitor as shown in the wiring diagram. Loosen the distributor, disconnect the vacuum lines, and start the engine. Using the timing light, turn the distributor until the engine is timed at exactly 0° BTC. Then adjust 0° ADJ pot *R5* for a meter reading of exactly 0°.

6. Turn the distributor for the greatest advance that can be read on the engine timing marker with the timing light (usually about 16° to 20°). Then adjust TIMING CAL pot *R4* for the same reading on the meter. Recheck the 0° adjustment, and if it is not right on 0°, repeat steps 5 and 6.

7. This completes the adjustments. Set the timing back to the factory specification and reconnect the vacuum lines.

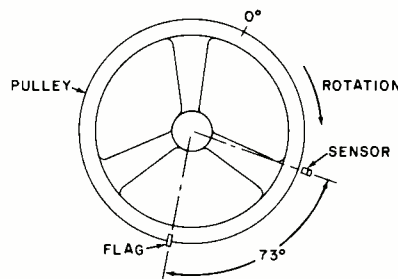

Fig. 4. Flag is positioned approximately 73 deg. from sensor when pulley is at 0-degree timing mark.

**How To Use the Monitor.** To get the most from your Ignition Monitor, we suggest that you make notes of ignition timing under different operating conditions. Do this when your car has been perfectly tuned, including a full distributor check. Make a note of timing at idle (on some engines, this depends on speed, vacuum, and engine temperature). By developing a feel for what to expect, you will quickly learn how to detect even subtle changes in engine performance.

Ignition timing specifications can be obtained from your car dealer and service manuals. Centrifugal advance and vacuum advance are normally specified separately. The engine can be run at various speeds with the vacuum lines disconnected to check centrifugal advance against the specs and then with the vacuum lines connected to determine vacuum advance. Make

sure that the dwell reading is steady. Jittery readings or sudden changes may indicate a worn distributor shaft. With most of the newer CD electronic ignition systems, the dwell reading is meaningless since current does not have to build up in the coil. In some systems, the dwell is electronically varied, depending on engine speed. In these cases, the manufacturer's specifications should always be consulted.

Some newer engines may have a negative timing angle under certain operating conditions (spark occurs after TDC). The Ignition Monitor will read down-scale from 0 under these conditions, but only until the pointer comes to the mechanical stop. Some newer cars, especially expensive foreign makes, come with voltmeters rather than the more common ammeter. In colder climates, proper voltage readings with the engine running and the battery charged should be 14 to 15 volts, while in hot weather, the reading should be 13 to 14 volts. The voltage regulator is designed to compensate for ambient temperature variations.

If you use your Ignition Monitor in more than one car, the flag must be properly placed by trial and error in each car. The 0° adjustment compensates for flag positioning on first car, so the flag on all other cars must be

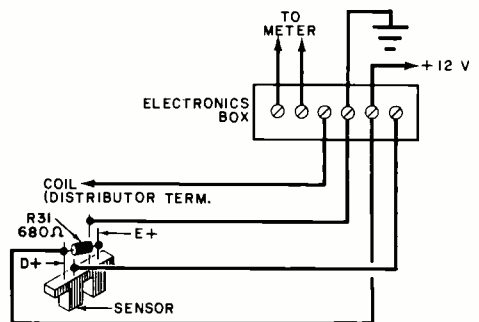
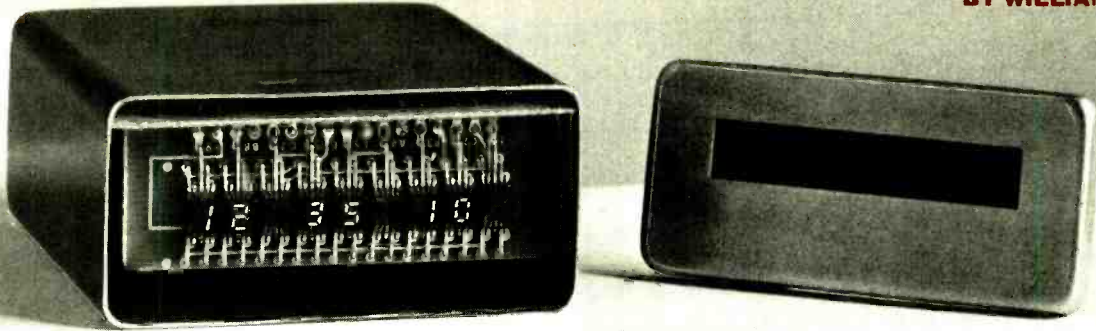

Fig. 5. External connections to the ignition monitor.

positioned in exactly the same manner. Keep in mind that small adjustments can be made by moving the sensor slightly, instead of moving the flag. We suggest that you permanently install a flag and sensor in each car with which the Ignition Monitor is to be used.

The Ignition Monitor has been designed for the serious auto enthusiast. When properly installed and used, it can help you diagnose engine problems and obtain optimum performance and economy. ♦



# A Digital Clock for Vehicles

*Six-digit, crystal-controlled LED clock keeps accurate time in hostile environment.*

**C**LOCKS with digital readouts are seemingly omnipresent today. However, you seldom see one in a car, camper, or boat. The clock project described here can change this. You can construct a low-cost 6-digit clock that is powered from a 12-volt dc source on anything from a pick-up truck to a cabin cruiser.

Obviously, such a clock is required to keep accurate time in a very hostile environment (including temperature extremes) and with a very noisy electrical supply. Also, since the clock must run continuously to maintain the correct time, it must require very little current. To avoid calling attention to itself when strangers look into an empty car or boat, the display should be darkened except when the ignition key is inserted. The mobile clock discussed in this article meets all of these requirements.

The 6-digit, 12-volt clock requires nominally 13 mA with the display off. Thus, if a 50-ampere-hour battery is used, battery life in excess of five months without recharging can be expected for the clock.

**Circuit Operation.** Timing for the clock (Fig. 1) is derived from a crystal-controlled oscillator operating at 6.5536 MHz. This is part of *IC2*. Also in *IC2* is a 16-stage binary counter that delivers an output of 100 Hz at pin 1. Trimmer capacitor *C5* is used to adjust the frequency (hence clock time keeping) for the desired accuracy. The 100-Hz output of *IC2* drives a divide-by-two flip-flop in *IC3* whose output at

pin 1 is 50 Hz, the frequency needed to drive clock chip *IC1*.

The clock chip contains the counting, dividing, display drive and multiplexing, and time-setting circuits. Some of the outputs energize the segments of the display, while others energize *Q1* through *Q6* to multiplex the display. Capacitor *C1* and resistor *R1* determine the multiplex frequency. Switch *S1* controls the slow set and *S2* controls the fast set.

Zener diodes *D2* and *D3* (with *C2* and *C3*) protect the IC's from potentially damaging voltage spikes. They also eliminate false counting due to noise from the ignition. Diode *D1* protects the circuit from wrong voltage connection.

**Construction.** Although any type of construction can be used, a printed circuit board (Fig. 2) is recommended to keep the size down. The IC's are protected against static discharge, but care must be used in handling and installing them.

Install all of the jumpers except for the one between *IC1* pin 16 and *IC3* pin 1. Then install all of the components as shown in Fig. 2. Be sure to observe the polarities on capacitors, diodes, and IC's. Sockets can be used for the IC's, if desired.

Solder a short length of bare wire into each hole in the bottom edge of the display board. The wire should protrude from the back side of the board and, after soldering, should be trimmed flush with the front side. Place the main board on a working

surface with the foil side down. Then position the display board with the readouts face up and the bare leads facing the front of the main board (toward the line of holes). Slip the leads from the display board into their mating holes on the main board and bend the display board up so that it forms a 90-degree angle to the main board. The two should be just barely touching. Keeping the display board perpendicular to the main board, carefully solder all of the interconnecting leads. Connect the insulated jumper between *IC1* pin 16 and *IC3* pin 1. Use short lengths of insulated wire to connect *S1* and *S2* to their respective pads on the board. Connect longer lengths of insulated wire to the power, ground, and display control pads.

Select a small metal case that will accommodate the assembly with the digits close to the front. The two set switches should be installed on the rear of the case, with the three leads (power, ground, and display control) coming out through a grommetted hole on the rear. If desired, the front panel can be cut so that a red plastic window magnifier (similar to those used in calculators) can be used over the numerals. The magnifier can be cemented in place on the inside of the front cover.

**Checkout and Calibration.** Connect the power and ground leads to a source of 11 to 14 volts dc observing the correct polarity. The display will come on when the control lead is connected to the positive supply. Operat-

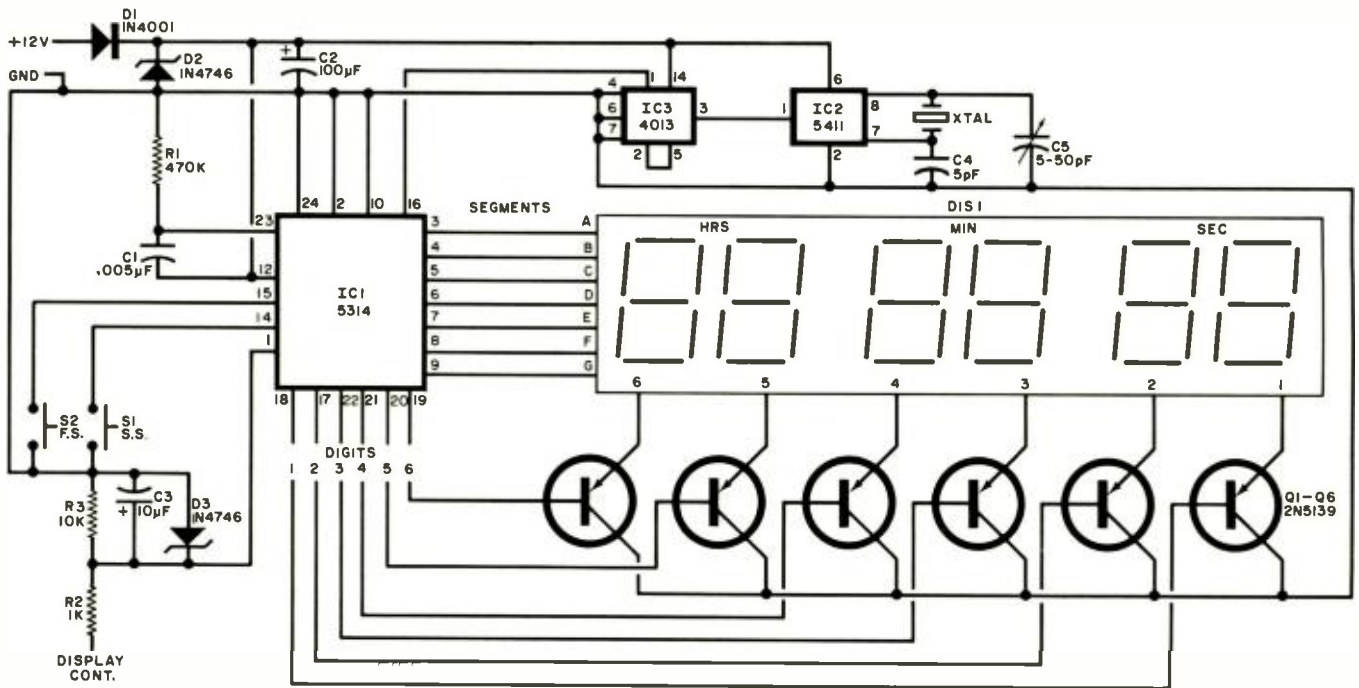

Fig. 1. Crystal oscillator is counted down by IC2 and IC3 to drive clock circuit in IC1.

- C1—0.005- $\mu$ F 16-V disc capacitor
- C2—100- $\mu$ F, 16-V electrolytic capacitor
- C3—10- $\mu$ F, 16-V electrolytic capacitor
- C4—5-pF ceramic disc capacitor
- C5—5-to-50-pF trimmer capacitor
- D1—IN4001 diode
- D2,D3—IN4746 zener diode
- DIS1—9-digit, 7-segment board (only 6 digits used) See Note.
- IC1—MM5314 clock module (National)
- IC2—SCL5411 oscillator-16-stage binary

#### PARTS LIST

- divider (Solid State Scientific)
- IC3—4013 dual D flip-flop (only one used)
- Q1 through Q6—2N5139 transistor
- R1—470,000-ohm, 1/4-W resistor
- R2—1000-ohm, 1/4-W resistor
- R3—10,000-ohm, 1/4-W resistor
- S1,S2—Spst, normally open, pushbutton switch
- XTAL—6.5536 MHz crystal
- Misc.—Suitable enclosure, red plastic

magnifier, cement, double-sided tape, mounting hardware, etc.

Note: The following are available from Alpha Electronics (Texas), Box 64726, Dallas, TX 75206: complete kit of parts less case (AC-1) at \$29.95 plus \$2.50 postage and handling; crystal at \$7.50; aluminum case with cover and magnifier (C-1) at \$4.50; etched and drilled pc board (140576) at \$5.00; assembled display board (AE-9) at \$4.95.

ing the slow set switch, S1, should cause the seconds to "run" rapidly and the minutes to operate at a faster speed than normal. The fast set switch, S2, causes the seconds to stop and the minutes and hours to run rapidly. Operation of both switches can be used to set the time.

To adjust the accuracy, and if you have a frequency counter, connect the latter between IC2 pin 7 and ground. Then adjust trimmer capacity C5 for a reading of 6,553,600 Hz. If you don't have a frequency counter, adjust C5 periodically by trial and error. Even if C5 is off slightly, the clock should still keep better time than most standard automotive clocks.

**Installation.** The clock can be installed under the dash or in any other convenient location. Connect the ground wire to any ground point on the vehicle and the +12-volt line to any point that is fused and is "live" even when the ignition key is removed. Connect the display control lead to any +12-volt line that is live when the ignition key is inserted.  $\diamond$

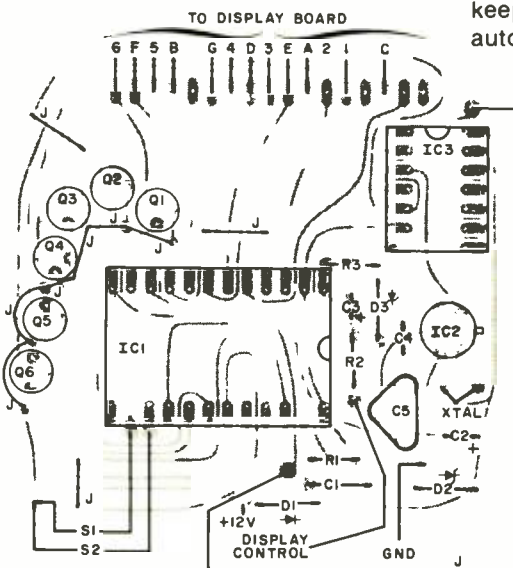
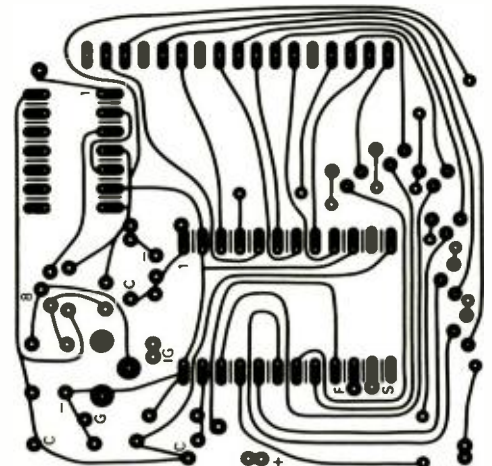

Fig. 2. Actual-size etching and drilling guide (right) and component layout (left) for digital clock. Holes at top of board align with those on the display board.





# Build the "ROADMATE" CB CONVERTER



BY DEAN TODD

*Compact converter allows you to listen to all 23 CB channels on any AM radio.*

**T**HE NEXT best thing to having a CB transceiver in your car is to be able to listen to any of the 23 CB channels through your car's AM radio. This way, you can keep up with the latest traffic information, know where the jams are and which roads are open and closed, etc. The low-cost "Roadmate" AM-to-CB converter discussed here lets you listen in for less than \$14 in parts.

The Roadmate connects directly between the existing antenna and car radio and only requires hookup to the car's electrical system to complete installation. You can leave the converter permanently connected because a switch allows selection of CB or AM listening.

**How It Works.** The schematic diagram of the converter is shown in Fig. 1. The converter, installed between the antenna and the radio's r-f input, serves as an added "front-end" for the radio. The antenna plugs into *J1*, while *P1*, located at the end of a length of coaxial cable (the same type used in car radio antenna installations), plugs directly into the antenna jack of the car radio.

When *S1* is set to CB, field-effect

transistor *Q1* is used as a mixer that accepts the incoming 27-MHz CB frequencies from antenna transformer *T1*. It mixes these signals with the 26-MHz third harmonic signal developed by the crystal-controlled *Q2* oscillator to produce an i-f of approximately 1 MHz. Since the car radio tunes from 550 to 1600 kHz, the output of the converter is roughly in the center of the AM broadcast band. This means that the car radio can be used as a "tunable i-f" so that the CB channels appear spotted along the AM band. Oscillator-to-mixer coupling is through *C4*, while r-f decoupling is provided by *L1*, *L2*, *C7*, and *C8*.

With *S1* in the CB mode, *LED1* is energized to give a visual indication of the type of operation.

Setting *S1* to RADIO switches *LED1* out of the circuit. It also completely bypasses the converter circuits and connects the antenna directly to the radio's input connector.

**Construction.** Best results will be obtained if the converter is assembled on a small printed circuit board, the actual-size etching and drilling guide and components-placement diagram for which are shown in Fig. 2.

Pushbutton switch *S1* and indicator *LED1* should be mounted so that they protrude through holes drilled in the front panel of the box in which the circuit is mounted. (The prototype project was housed in a 4¼" × 3¼" × 1¼"—10.8 × 8.3 × 3.2 cm—metal box.) Suitable mounting holes should also be drilled to allow the pc board to be mounted on spacers inside the box.

Mount antenna jack *J1* on the rear panel of the box, with the coaxial cable to which *P1* is connected exiting the box near the jack. Use red and black stranded hookup wire for the "hot" (+) and ground power leads, respectively. These wires should exit the box through a rubber-grommet-lined hole in the rear panel.

Use a pair of small L brackets or double-sided adhesive foam tape to mount the converter to the underside of the dashboard or wherever you feel it will be convenient to reach.

**Installation and Operation.** With the converter mounted as desired, connect the black power lead to any metal portion of the car's chassis and the hot (red) lead to any 12-volt line that is "live" when the ignition or car radio is turned on. Unplug the antenna

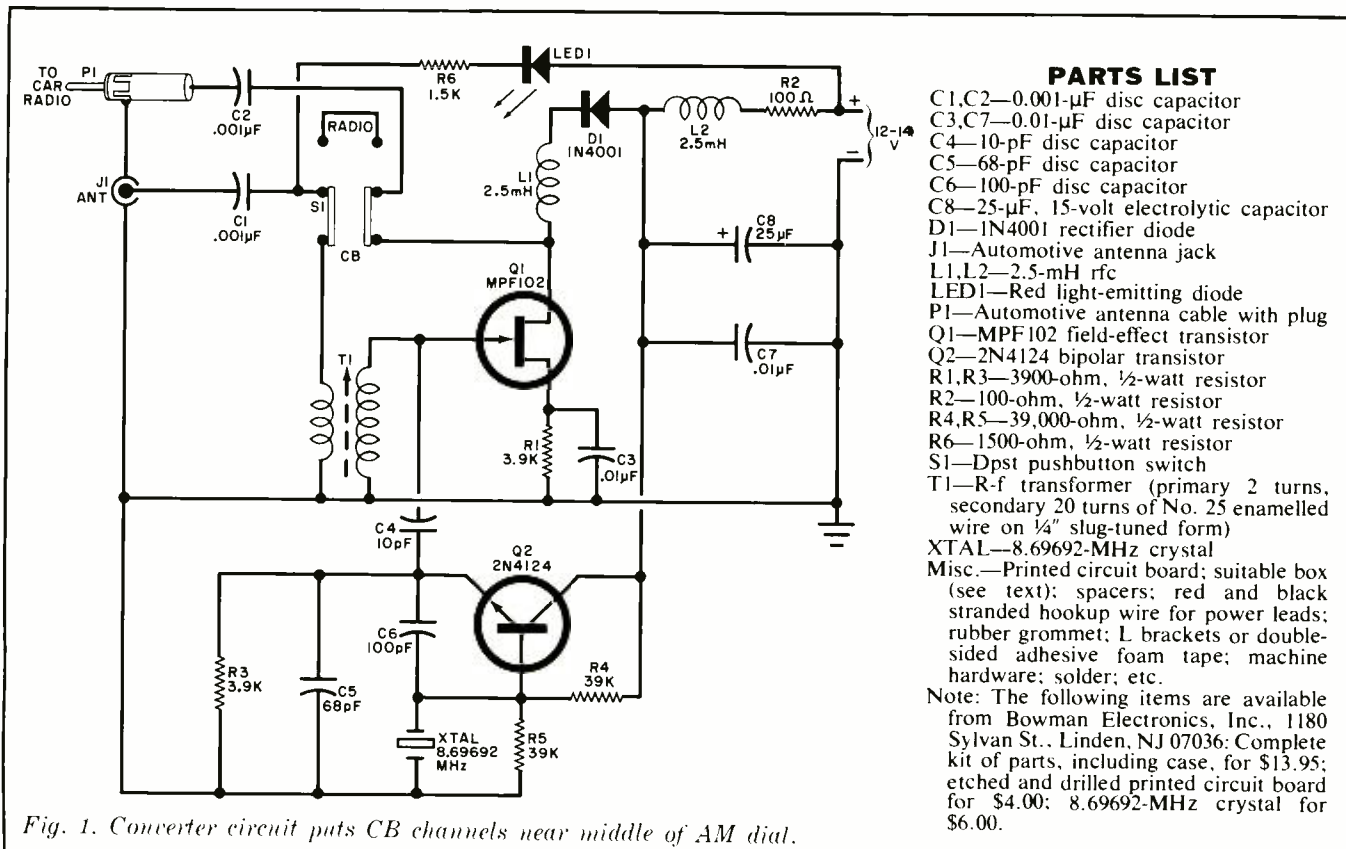

Fig. 1. Converter circuit puts CB channels near middle of AM dial.

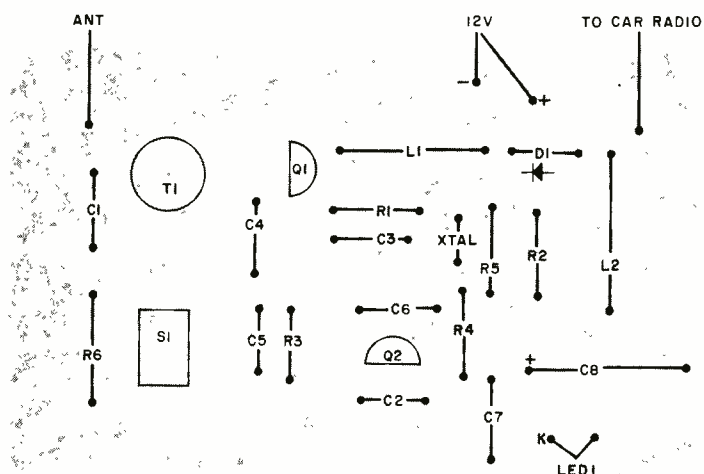
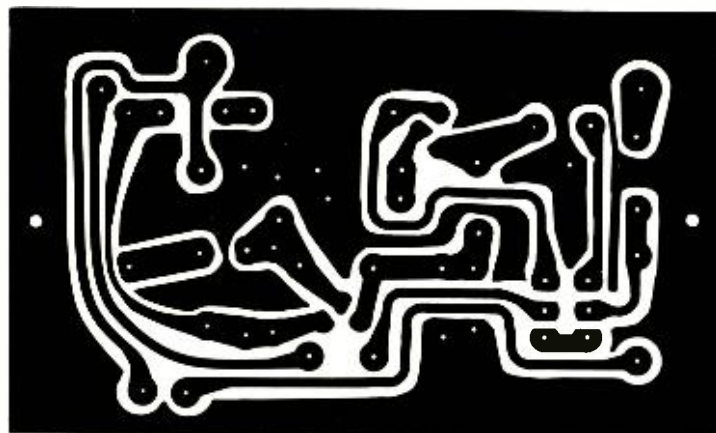

Fig. 2. Etching and drilling guide (top) and component placement for the converter.

from the car radio and plug it into *J1* on the rear of the converter. Then plug *P1* at the end of the converter's coaxial cable into the radio's antenna input jack.

Turn on the car's ignition (or radio) and depress *S1*. This sets the converter up for CB operation. The LED on the front panel should glow. Tune the car radio to about the center of the AM dial (approximately 1000 kHz) until you hear a CB transmission. As you continue tuning, you should be able to pick up all 23 CB channels. You can now "peak" *T1* and the car radio's antenna trimmer capacitor for best reception.

Set *S1* to its alternate (RADIO) position. The LED should extinguish and you should be able to tune standard AM broadcast stations as usual.

**Options.** By changing the crystal frequency, it will be possible for you to pick up other frequencies near the 27-MHz CB band, such as hams working 10 meters (28 MHz). By changing the windings of *T1* and the crystal frequency, it is possible to tune in some of the popular shortwave bands, including WWV. Of course, you will have to experiment with the windings of *T1*, and you will have to select a crystal so that one of its harmonics falls within 1 MHz of the desired frequency. ♦

# What's New In Tape Recorders?

*An overview of recent developments in tape decks and formats.*

## ... Four. Three. Two. One ...

- 0.0005:** Oscillator start-up.
- 0.008:** Commence roll program.
- 0.100:** Brakes off; pinch rollers on; motion start-up; head lock-in.
- 0.520:** Motion stabilized; commence R & P programs.
- 0.590:** Record current in line.
- 0.750:** Play circuits in operation.

**T**HAT isn't dialogue from a Cape Kennedy blockhouse of course, but an account of what happens inside a late model cassette deck in the first three quarters of a second after you go from stop to record. However, the resemblance to the programmed operations of Mission Control is both striking and intentional and is indicative of the sophistication in control and performance features found in many of today's recorders. To update you on such new developments, let's take a brief look at the cassette and open-reel scene.

**Noise Reduction Systems.** The slow tape speed and narrow track width of cassettes make some form of noise reduction necessary if hiss levels are to be kept competitive with phono discs and open-reel tapes. Six years ago, Dolby-B was about to be incorporated into a cassette recorder (the Advent 200) for the first time. Today, excepting inexpensive portables, it's hard to find a cassette that isn't equipped with this valuable system, in either discrete or IC form. To facilitate comparison with some of the newer alternatives to Dolby, a short review of

its operation is in order. The Dolby-B record characteristic, shown in Fig. 1A, affects *only* high-frequency, low-level signals, which are boosted (pre-emphasized) by carefully-controlled amounts before they reach the recording head. All other signals pass through the Dolby circuitry unchanged. The recording process will subsequently add some hiss, of course, but it is now below the level of the high frequencies which it might otherwise mask. On playback, the same frequency-sensitive network that was used for pre-emphasis now brings the highs back to their original levels (de-emphasis), as shown in Fig. 1B. Tape hiss is treated just like any other low-level, high-frequency signal, and is attenuated. An overall increase in signal-to-noise ratio (S/N) of about 10 dB is possible using this system.

The JVC "ANRS" noise-reduction system is sufficiently close in its operation to Dolby-B that tapes made on the one can successfully be decoded on the other. Recently, however, JVC has developed a second NR system called "Super ANRS" which treats the high-level, high-frequency signals

that Dolby and regular ANRS leave untouched. Within the upper portion (about -15 VU and above) of the dynamic range, the problem that cassettes face is not audible hiss, but high-frequency tape saturation. The large amount of record pre-emphasis that is an essential part of cassette recording can boost seemingly low-level program material, if high enough in frequency, to a level beyond what the tape can handle. The Super-ANRS circuitry detects these dangerously "hot" high frequencies and compresses them to a point that is acceptable to the tape before they are applied to the record head. On playback, these high frequencies are expanded back to their original level. This process, whose record and playback characteristics are shown in Figs. 2A and 2B, respectively, permits a somewhat higher overall recording level to be used than would otherwise be possible, resulting in an increase in S/N.

JVC is not the only company with an alternative to Dolby-B processing, however. dbx has recently announced that henceforth the Teac line will offer consumers a choice between incorporating Dolby or dbx noise-reduction

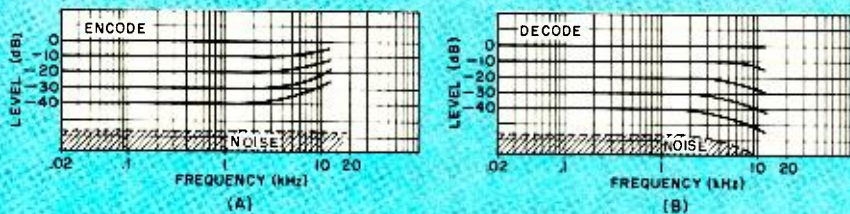

Fig. 1. Dolby-B noise reduction uses level-sensitive pre-emphasis on record (A) and complementary de-emphasis on playback (B).

circuitry. Unlike the systems previously discussed, the dbx technique, which has already generated considerable enthusiasm in the field of professional recording, does not restrict itself to portions of the frequency range and signal-level range. It's an all-out 2:1 compressor-expander (or *componder*) which in theory could turn a cassette machine with a 45-dB signal-to-noise ratio into one with a 90-dB S/N! Because a certain amount of this tremendous increase will be used to provide additional headroom, the company's claims are slightly more modest—an effective noise reduction of 30 dB, as compared to Dolby-B's 10 dB. (Dolby cannot, however, decode Dolby-B cassettes, or vice versa.) Furthermore, because it has so much dynamic range to spare, the *dbx* system has no need of level-calibration tones and matching, which can make the Dolby system difficult to use. (If you use a tape with higher or lower overall sensitivity than that which was used to calibrate a Dolby system, frequency response will be altered when the tape is decoded.) To date, *dbx* noise-reduction has been available only as an add-on accessory; but now that Teac has taken the plunge, it is probable that other manufacturers will follow suit.

All three systems we have examined require flat frequency response, because roughly speaking, any frequency response errors between the encoding and decoding process will

be multiplied by the amount of compression used. For example, assume you are using the *dbx* system. (Dolby or ANRS would be similar, but not as drastic.) Your overall record/playback is down 3 dB at 10,000 Hz and you're recording a tone at this frequency whose true level is -30 VU. The noise-reduction circuitry compresses it by 2:1, and so records the tone on the tape at -15 VU. The tape, in this example, however, loses 3 dB at this frequency, so that, when the tone comes back for decoding, it does not arrive at -15 VU, but at -18 VU, instead. The decoder doesn't know about the error, however, and applies its 2:1 expansion factor, so the tone is now reproduced at a -36 VU level, representing a 6-dB loss in level.

The attempt to achieve wide, flat frequency response from the cassette medium goes beyond the specific needs of noise-reduction systems, of course, and today's cassette recorders are responding to the challenge in two basic ways: more bias and equalization combinations to meet the requirements of improved tapes; and improved heads.

**The New Tapes.** For years, every "quality" cassette recorder has carried a two-position switch to change bias, equalization, and (usually) meter calibration for ferric oxide and chromium dioxide cassettes. Indeed, there has even been considerable success in getting hardware and

software manufacturers to use a small slot in the rear of the cassette housing for a sensing arm that would make this switching automatic. But this presupposed that there was *one* basic ferric bias and equalization machine setting (as there is for CrO<sub>2</sub>), which, up to and including development of TDK SD tape, was essentially true. With the exception of 3M's "Classic" cassettes, it remains true for American and European tapes, which are manufactured to use "DIN" or "standard" bias. (There are, of course, frequency response differences among these tapes, but no one has proposed adding switch positions to equalize these). However, to achieve a high-frequency response as good as (or slightly better than) chromium dioxide, tape formulations from Japan have been introduced (Fuji FX, Maxell UD and UD-XL, TDK Audua, Nakamichi EX and EX-II, etc.) which require more bias current and (depending somewhat on the machine) slight equalization changes as well. This would mean a three-position switch—HIGH, STANDARD, and CrO<sub>2</sub>—or at least a choice (often unstated in owner's manuals) as to which "ferric" bias was being used. Then, to add to the confusion, came the "ferri-chrome" tapes (Sony FeCr and 3M Classic), consisting of a very thin layer of chromium dioxide on top of a thicker coating of ferric oxide, which require still another equalization characteristic (or, sometimes, a bit of juggling between bias and equalization switch settings.)

To round out the picture, the most recent crop of ferric tapes (TDK SA, Nakamichi SX, and Maxell UD XL-II) are designed to work with the chromium dioxide settings, taking advantage of the additional signal-to-noise ratio that they afford. All this represents progress, of course, but it adds an element of cost and potential consumer confusion if decks are to keep response as flat as possible with more and more tape innovations.

**Heads and Transports.** As long as cassette machines weren't expected to have a frequency response beyond about 12 kHz, a combination record/playback head with a gap width of about 2 microns (78 millionths of an inch) was considered an acceptable compromise. But many of today's decks go well beyond this, which means using a head with a narrower gap, such as 1.5 microns (60 mi-

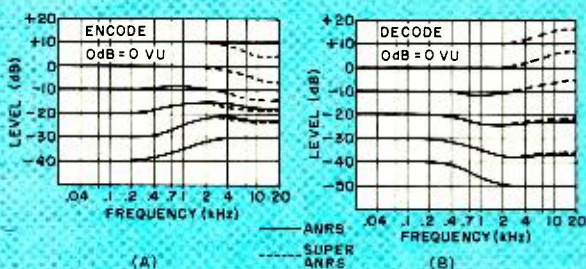
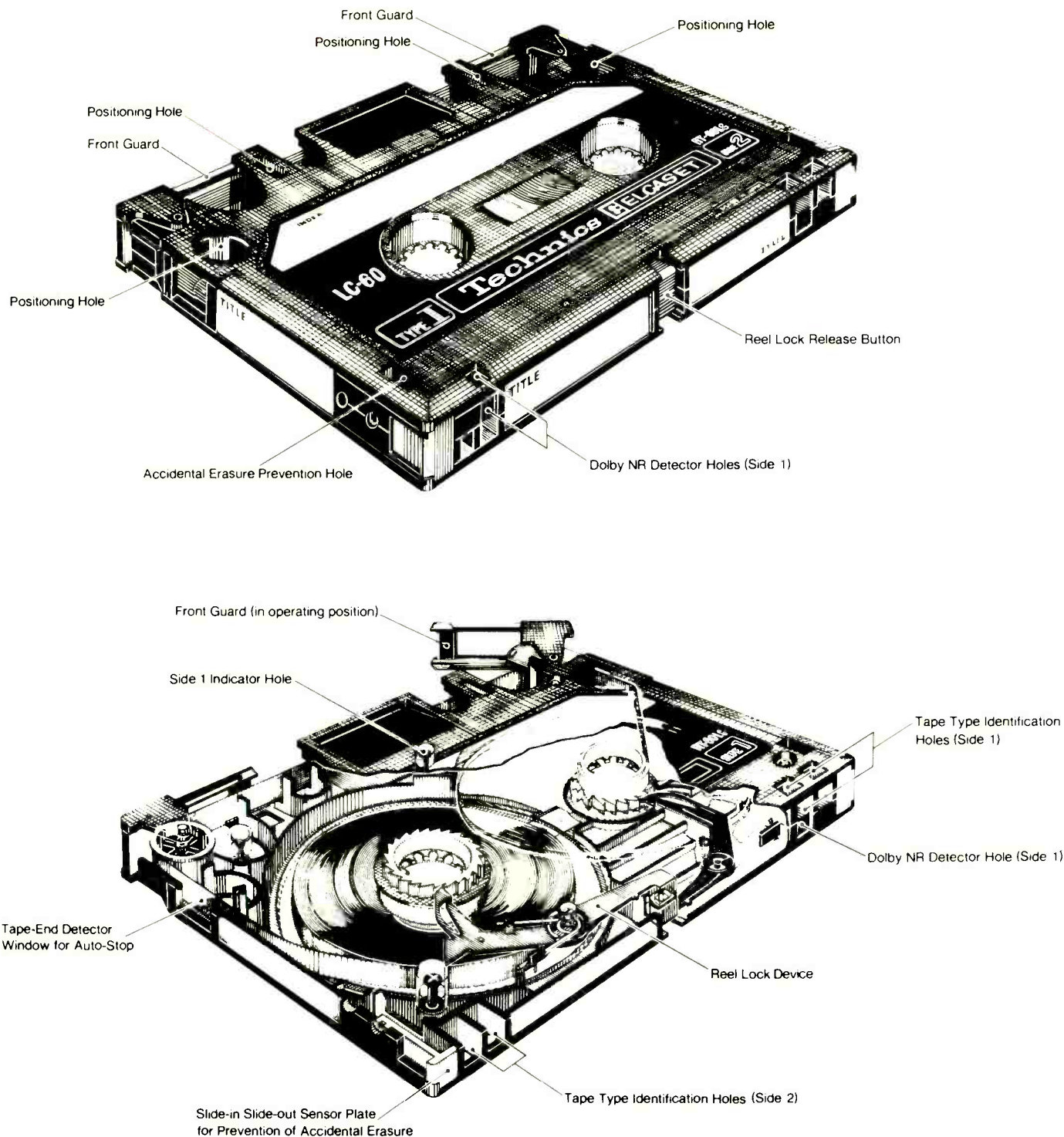

Fig. 2. Record (A) and playback (B) characteristics for JVC's new Super ANRS. It has high-level treble compression to avoid tape saturation.



*Fig. 3. Structural features of the new Elcaset. Format includes provisions for automatic switching of bias, etc.*

croinches). Unless a special head design (for example, the "focused gap" Nakamichi technique) is employed, there is no way the head is going to be able to penetrate the full depth (about 5 microns) of the oxide coating on the tape during the record cycle.

The inability to "monitor off the tape," which requires separate record and playback head gaps, represented the final point of resistance in accept-

ing the cassette as a full-fledged high-fidelity recorder. The Nakamichi 1000 (and 700), with a separate record (5-micron gap) and playback (0.7-micron gap) heads, and an alignment system to optimize adjustments for each cassette (frequency response on many premium cassettes goes beyond 20 kHz), settled anybody's lingering doubts, but at a price very few audiophiles could even consider.

In today's market there are several "three-head" cassette machines to consider (Technics, Fisher, Sony, and Hitachi), and this is clearly the direction more manufacturers will take. The Hitachi is particularly interesting in this connection, for its 1.2-micron playback head and 4-micron record head actually share the same shell, reducing the need for "fine tuning" the record azimuth (a la Nakamichi) for

each cassette. As to whether heads should be made of ferrite or permalloy, each partisan's choice is much clearer than his argument. If wear is the principle concern, the nod goes to ferrite; but for very narrow gap application or very high record currents, permalloy appears to have the edge.

The transport mechanisms of many of today's cassette decks have taken full advantage of developments in semiconductor control circuitry. Servo-control capstan drives, which are now common, have contributed to the lowering of wow and flutter figures generally. Another important step in this direction is the dual-capstan drive, which isolates the length of tape actually crossing the heads from any eccentricities in the supply and take-up spools. Two-motor transports have further simplified the drive mechanisms and provided greater reliability. Logic circuits operating solenoids have made possible such features as automatic rewind and even selectable "memory rewind," in which the cassette will return to a specified point and "play it again, Sam." If the automatic reversing feature is of interest to you, you'll find it in decks by Akai and Dual.

Cassettes began their meteoric rise to popularity simply as battery-operated dictating devices; but after acquiring "hi-fi" status, scant attention to truly portable operation was paid. Happily, among today's models, that oversight has been corrected. If you need a quality machine capable of being battery powered, you can choose models from Sony, Nakamichi, JVC, Uher, and Yamaha.

**New Cassette Sizes.** The only troublesome cloud on the horizon for today's cassettes is the fact that the once standardized cassette package is now being threatened by two new cassette sizes. On the one hand, Philips (originators of the standard cassette format) has been experimenting with another portable dictating device, which is even smaller and operates at slower speed than the "cassette." In all likelihood, this mini-cassette package will remain confined to voice recording applications, though one never knows!

Of greater immediate threat to the standard 1 $\frac{7}{8}$ -ips cassette as we know it is a recent announcement made by three tape deck manufacturers—Sony, Technics by Panasonic and Teac. The three have reached an

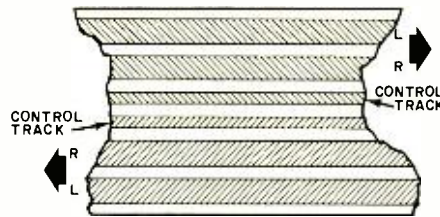

Fig. 4. Elcaset has four audio and two control tracks on quarter-inch wide tape.

agreement on the "standardization" of a tape package which they call the Elcaset. The Elcaset system realizes both the convenience of the more compact cassette (the new Elcaset package is approximately as large as an 8-track cartridge), but from all preliminary indications will be able to offer further improvements in sound quality and consistency of tape motion.

For example, the Elcaset will house quarter-inch tape, the same width used in open-reel machines. This, combined with a tape speed of 3 $\frac{3}{4}$  ips, should provide much wider dynamic range (or improved S/N) than is possible with regular cassettes. In addition, the tape itself is pulled out of the Elcaset shell for transport across the tape heads, so that precision of shell construction (or lack of it) will have little effect on the running of the tape.

A diagram of the new Elcaset's construction is shown in Fig. 3. Note that several "detection holes" for a variety of automated features are built right into the cassette shell. These extra holes can provide for automatic selection of proper bias and equalization to match at least three types of tape. A notch will also detect whether or not noise reduction circuitry is to be switched on for playback of a given Elcaset, which side is being played, etc.

Compatibility between mono and stereo tapes will be retained (just as it is in standard cassettes) and the track pattern, at least as far as audio tracks are concerned, will be the same as that of standard cassettes, as illustrated in Fig. 4. Note, however, that there are two additional narrow tracks running along the center of the tape. These are intended as control tracks—one for each direction of tape travel—which could be used to record synchronizing pulses (for film or slide presentations, etc.) and may also serve for other control purposes not yet imagined.

Sony has already produced at least two tape decks designed for use with the new Elcaset package and others

are sure to follow. The three sponsors of the new package indicate that Aiwa and the Victor Company of Japan, Ltd (JVC) have also agreed to adopt the new Elcaset format in products they will manufacture for consumer use. It is difficult to predict what impact the Elcaset will have on the presently expanding standard cassette market; but certainly with many important companies behind the new project, the Elcaset bears watching in the future. At the very least, its potential for better fidelity is sure to appeal to the really demanding audiophile, who, until now, would settle for nothing less than a high-quality, open-reel tape deck.

**Open-reel Tape Decks.** These machines have always enjoyed their greatest popularity among serious recordists, whose frustrated desire all along has been to own the genuine studio article. They accepted the quarter-track format only with reservations. After all, the pro's gain 3 dB in S/N by using half-track, and if you expect to be doing a certain amount of editing, there's not even a tape saving. How about 3 $\frac{3}{4}$  ips? Suitable for background music perhaps, but surely not for anything serious! The very inconvenience of tape threading is turned into a ritual to be performed with practiced ease to conjure up the closest approximation to the live performance. And now that cassettes have all but completely driven the low and middle priced open-reel machines from the market (there seem to be more decks for over \$1000 than for under \$500, though most are in between), the open-reel enthusiast can survey the current offerings with the satisfaction of having been right all along. The studio goodies, right down to multi-tracking, are simply pouring forth.

For starters, 10 $\frac{1}{2}$ " reels and a 15-7 $\frac{1}{2}$  ips option are in almost everyone's line, and anything less than three heads and three motors has virtually disappeared. The higher tape tensions, rotational forces encountered, and greater demands on the braking systems that go with the big reels have had the salutary effect of forcing recorder manufacturers to pay more attention to the design of their transport mechanisms. In addition to heavier motors, one result has been the widespread introduction of "logic-controlled" decks, whose solid-state circuits sense tape motion and speed,

and prevent the accidental execution of commands (e.g. to go directly from rewind into play without first coming to a full stop) that would fill the room with flying tape bits. And once logic-actuated solenoids are in place, full remote control, automatic reversing (Akai, Sony, Teac), and memory rewind (Teac and Revox) are relatively easy to provide.

Quite a number of open-reel manufacturers turned to dual-capstan, "closed-loop" drives (Akai, Revox, Sony, Teac) to insulate the tape from any shocks that might be transmitted from the supply reel. The Sony TC-880 and Revox A700 take advantage of this to provide a counter that reads directly in minutes and seconds rather than in arbitrary revolutions. The Revox goes even a step further by providing a sensing device that servo-controls the supply and take-up reel tensions even when reel sizes are intermixed. The Sony, for its part, boasts what is surely the most advanced metering system made available to the home recordist: a 55-dB range, light-actuated meter whose characteristics can be set either for VU, for peak-reading, or to hold the highest peak encountered. Again, to control tape speed both instantaneously (i.e. to ensure against

wow and flutter) and over a period of time (for variable pitch, for example), a number of machines have gone to servo-controlled capstan motors. Several, too, utilize plug-in head block assemblies, so one can select between half-track and quarter-track formats, and many provide front-panel bias adjustment (by switching, continuous control).

While 4-channel sound in general has not taken the country by storm, response to 4-channel recorders with a multi-sync capability (Akai, Crown, Dokorder, Otari, Teac) has been extremely strong, underlining the desire of many recordists to copy the studio technique of multi-tracking, or "over-dubbing." If this sounds strange to you, consider that in producing a typical pop hit, 8, 16, 24, or even 32 individual sound tracks will be recorded—often over a period of days or even weeks—all of which must ultimately be combined ("mixed down") into conventional stereo. Each track must nonetheless be recorded in perfect synchronization, or the mix-down becomes an impossibility. To achieve this, each successive performer listens (via headphones) to a playback of what has been previously recorded. But this playback must *not* come from

the normal playback head, or his own efforts would be displaced by the amount of time it takes the tape to move from the record to the playback head. Instead, a "multi-sync" switch (known by various trade names) is thrown to temporarily convert part of the record head (where a track has already been laid down) into a playback head. The fidelity of this kind of playback isn't as good as the regular playback head will later provide, but it keeps everything together.

A home 4-channel recorder doesn't have the full flexibility of the studio machine, of course, but surprising things can be done. If tracks 1, 2, and 3 are recorded individually, they can then be combined (adding still a fourth live part, if desired) onto track 4. If the mix is satisfactory, tracks 1, 2, and 3 can be erased and re-used, after the same fashion. This tends to meet the needs of most groups, allowing them to work out their arrangements so fully that if they have to go into a studio at all, they will require minimum studio time. Given what studios charge today, the savings can pay for a 4-channel machine rather quickly. But maybe even more important in the long run, is the fact that it's *fun* to be your own engineer! ♦



## Fix it Quick...

with an  
**Ungar® Cordless Quick-Charge Soldering Iron**

- Cordless portability
- Quick 4-hour charge
- Holder automatically charges high performance NI-CD battery
- Rigid coaxial tip rotates to desired working position
- Easy-touch switch, tunnel light
- Quick heat-up

### SPECIAL OFFER

#### Free Micro-Spade Element Tip

Present this coupon to your local participating Ungar electronic distributor and receive a FREE #195 Micro-Spade Element Tip worth \$1.99 with your purchase of a #200 QUICK-CHARGE CORDLESS SOLDERING STATION.

HURRY! Offer EXPIRES December 1, 1976.



Division of Eidon Ind., Inc. • Compton, CA 90220



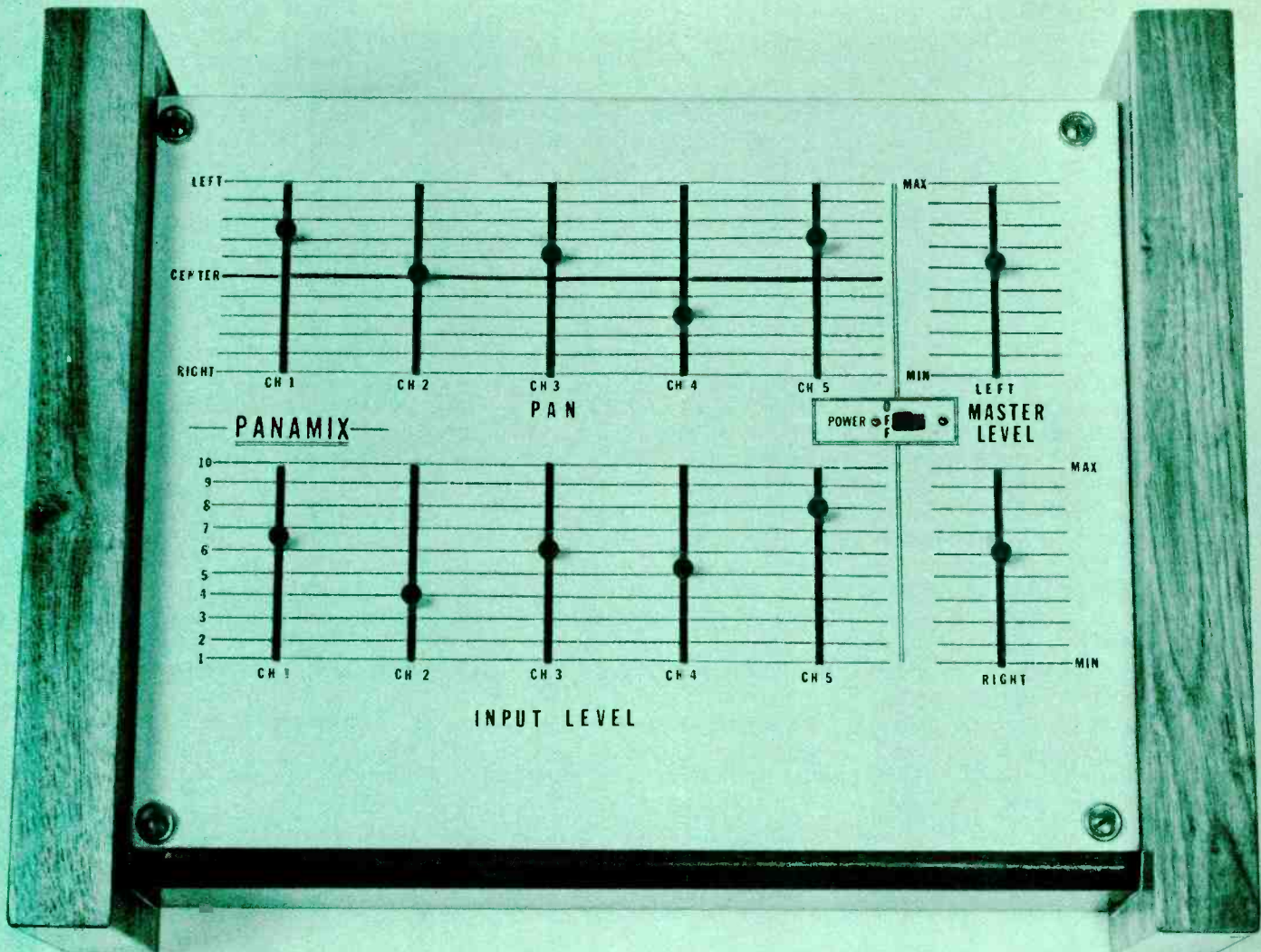

# Build PANAMIX

*A low-cost, 5-input  
stereo/mono audio mixer  
with full panning*

BY JAMES BARBARELLO

**P**ANAMIX is a stereo/mono mixer that can handle up to five inputs at once, and has full panning capability. Unlike many other mixers, it will allow you to position each program source at full left, full right, or anywhere in between.

All controls, including input and master level controls, are slide potentiometers, giving the project the look and "feel" of a studio-type mixing panel. Panamix also uses readily available components, such as 741-type op amps. Current drain is so low that 9-volt transistor batteries are a practical and economical power source. Total parts cost is only about \$30.

**About the Circuit.** Referring to the schematic diagram (Fig. 1), three distinct sections can be identified. The first is the input level control section

POPULAR ELECTRONICS



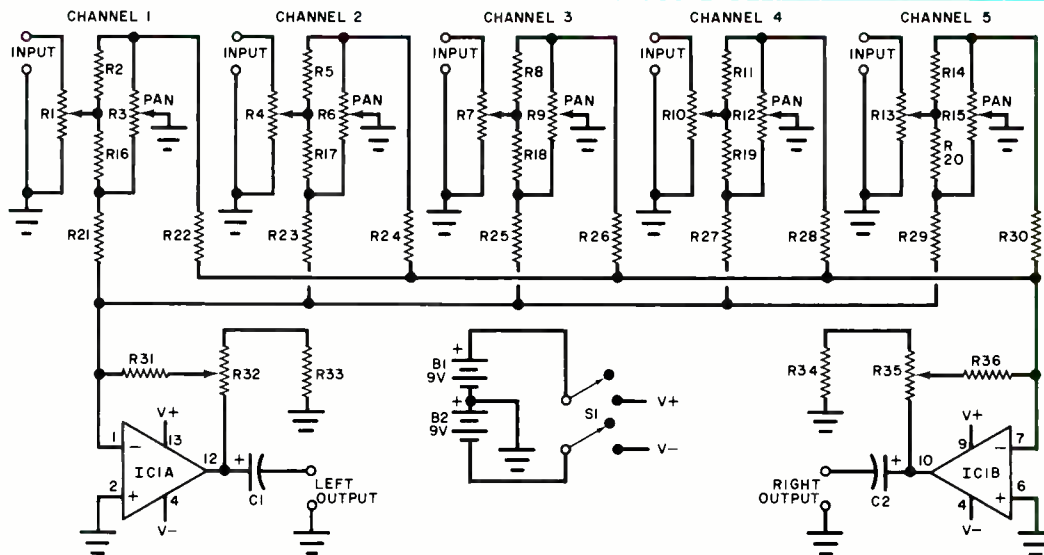

Fig. 1. Schematic diagram shows how five input channels are mixed down to a stereo output by an op amp summer.

### PARTS LIST

B1, B2—9-volt transistor battery  
 C1, C2—1- $\mu$ F, 16-volt electrolytic capacitor  
 IC1—747 dual operational amplifier  
 R1, R3, R4, R6, R7, R9, R10, R12, R13,

R15, R32, R35—10,000-ohm slide potentiometer (Radio Shack 271-223)  
 R2, R5, R8, R11, R14, R16 through 31, R36—10,000-ohm, 5%, 1/4-watt resistor  
 R33, R34—1000-ohm, 5%, 1/4-watt resistor  
 S1—DPDT toggle switch

Misc.—Battery clips; 10"  $\times$  7" printed circuit board; 7 miniature phone, RCA phone, or 1/4-inch phono jacks; hookup wire; solder; wood and sheet metal screws; etc.

(R1 for Channel 1), a 10,000-ohm potentiometer. It presents a constant resistive input impedance of 10,000 ohms and provides a variable amplitude signal to the second section, the panning circuit. For the input Channel 1, it consists of R2, R16, and potentiometer R3. As the wiper of R3 is moved upward, less and less signal appears at the right output, while more and more appears at the left output. If the wiper is then moved downward, the apparent position of the signal source moves from left to right. Although the position of the panning control does affect the total output of the panning section, the variation is not audibly noticeable.

The left and right outputs of the panning section are then processed by the third section, which performs output summing and level control functions. For the left channel output, it is composed of R21, R23, R25, R27, R29, R31, R32, R33, C1 and IC1A. These components form an op amp summer whose gain, allowing for losses in the panning section, is about 15 dB over the input signal level. The output impedance of each section of IC1, a 747 dual op amp, is about 75 ohms. Thus it will drive almost any

preamp or power amp with a medium to high input impedance. Each output is capacitively coupled to dc-isolate the output stage of the op amp from the output jacks.

**Construction.** "Panamix" is best assembled using a 10"  $\times$  7" (25.4  $\times$  17.8 cm) printed circuit board. Figure 2 shows the etching and drilling and parts placement guides. Start by inserting all fixed resistors and soldering them into place. Then insert and solder IC1, using an IC socket or Molex Soldercons, if desired.

The slide pots have three terminals (one at one end and two at the other) and two tabs near the center. Insert each potentiometer carefully, so that the two tabs are touching the circuit board and the body of the potentiometer is perpendicular to the pc board. When you have correctly positioned each potentiometer, solder it in place. Then install C1, C2, R33 and R34 on the foil side of the board. This is done so that the board can be mounted in a custom enclosure. Attach leads for the input and output jacks and for S1, also using the foil side of the board. These leads are connected to the foil side to prevent any interference with the mo-

tion of the slide pots. All input and output leads should be shielded. The choice of connectors is optional. The author used miniature phone jacks for input and output connections, but RCA phono or standard 1/4-inch phone jacks can also be used.

Because the circuit draws only  $\pm$  4mA, two nine-volt transistor batteries are used for a power source. You can power the Panamix from a line-operated supply, of course.

With all parts and connectors in place, Panamix is electrically complete. However, you will probably want to build an enclosure for the mixer. So a custom cabinet plan is included.

Layout of the front panel, which is formed from an 11"  $\times$  8 1/2"  $\times$  1/8" (27.9  $\times$  21.6  $\times$  0.32 cm) piece of Masonite is shown in the photo. Twelve 2 1/4"  $\times$  1/8" (57  $\times$  3.2 mm) cutouts should be made to accommodate the control slides. A 1/4-inch (6.4-mm) hole is for power switch S1. Assembly details for the case are shown in Fig. 3. Hardwood is suggested for all sections except the circuit-board supports, which should be pine. White glue and 1/4-inch (6.4-mm) dowels can be used for mechanical rigidity and a pleasing appearance.

When the case and front panel have

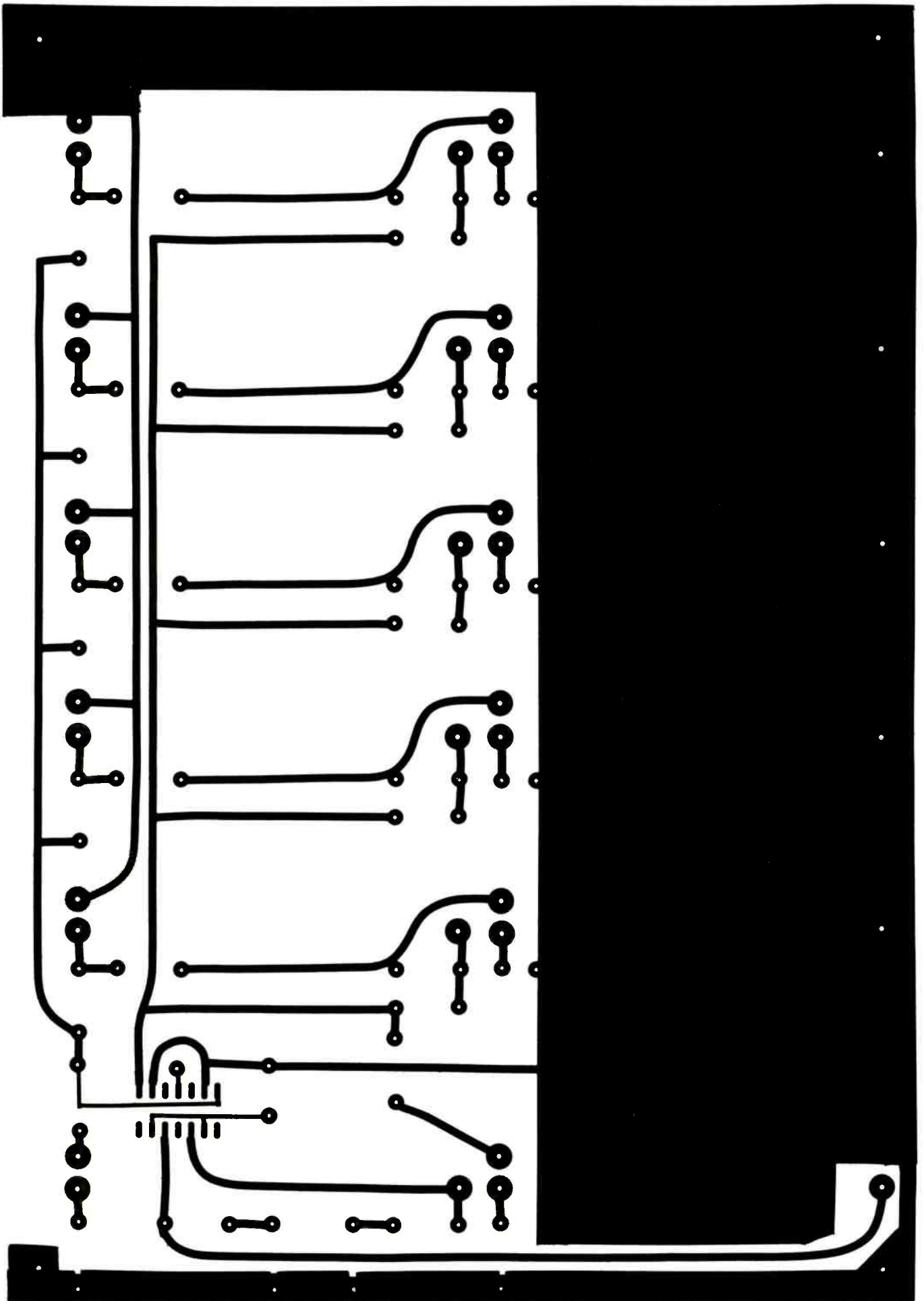

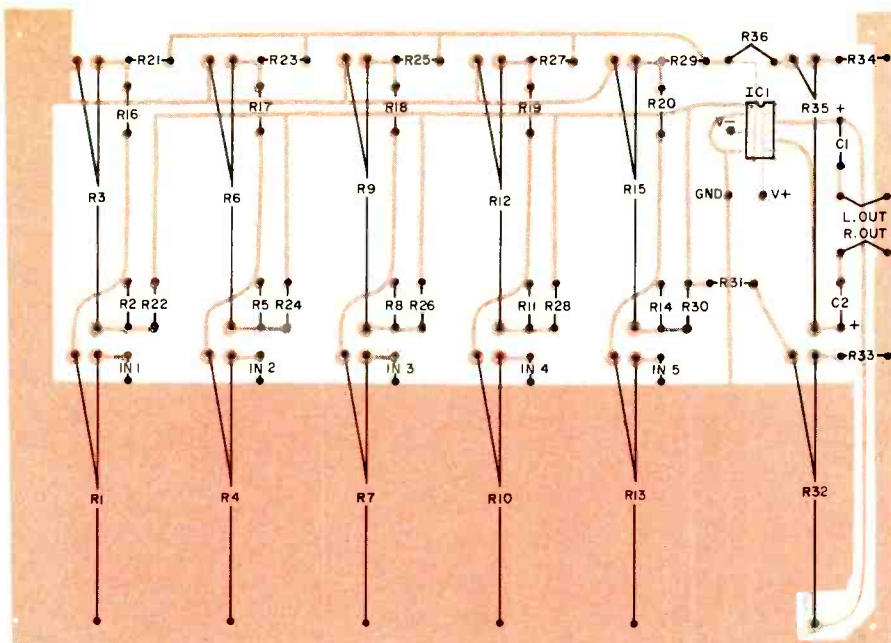

Fig. 2. The actual size etching and drilling guide for the printed circuit board is shown on the opposite page. Layout of components on the board is above.

been assembled, mount the panel and secure it to the support, with wood screws. Then turn the case upside down, and insert S1 into its mounting hole. Position the printed circuit board so that the slide controls move freely in their front panel slots. It might be necessary to bend the controls' solder lugs slightly to obtain smooth

motion, but be careful not to damage the pots, the board, or its foil. When the board has been properly aligned, it should be secured to the pine supports with self-tapping sheet metal screws. Press knobs down on each slide control.

A rear panel should be fabricated from a 12" x 1 1/2" (30.5 x 3.8 cm) piece of 16-gauge aluminum stock. Bend

the piece of aluminum at right angles 1/2" (1.27 cm) from each end to form a stubby "U" shape. Then attach the panel to the case, sinking sheet metal or wood screws through both arms of the "U". Drill mounting holes for the connectors you wish to use along the rear panel, and secure the jacks to the panel. Situate the batteries in any convenient location that will allow easy replacement. A retaining bracket for the batteries can be fashioned from a scrap of aluminum stock and should be secured to the case with a sheet metal or wood screw.

**Using the Mixer.** You can perform many different mixing functions with Panamix, such as converting a four channel "master" of a musical performance into a stereo format, mixing a multiple microphone conference setup into one or two tracks for recording or PA purposes, etc. You need only remember that panning position integrity with respect to the front panel markings is maintained *only* when both master level controls are set for equal volume. A significant difference between the levels of the output channels will shift the apparent "center" to one side. Experiment with all controls to get used to their "feel." For mono use, place all PAN controls to one side and use the appropriate output channel. ♦

Fig. 3. A custom case for the Panamix can be made using this guide.

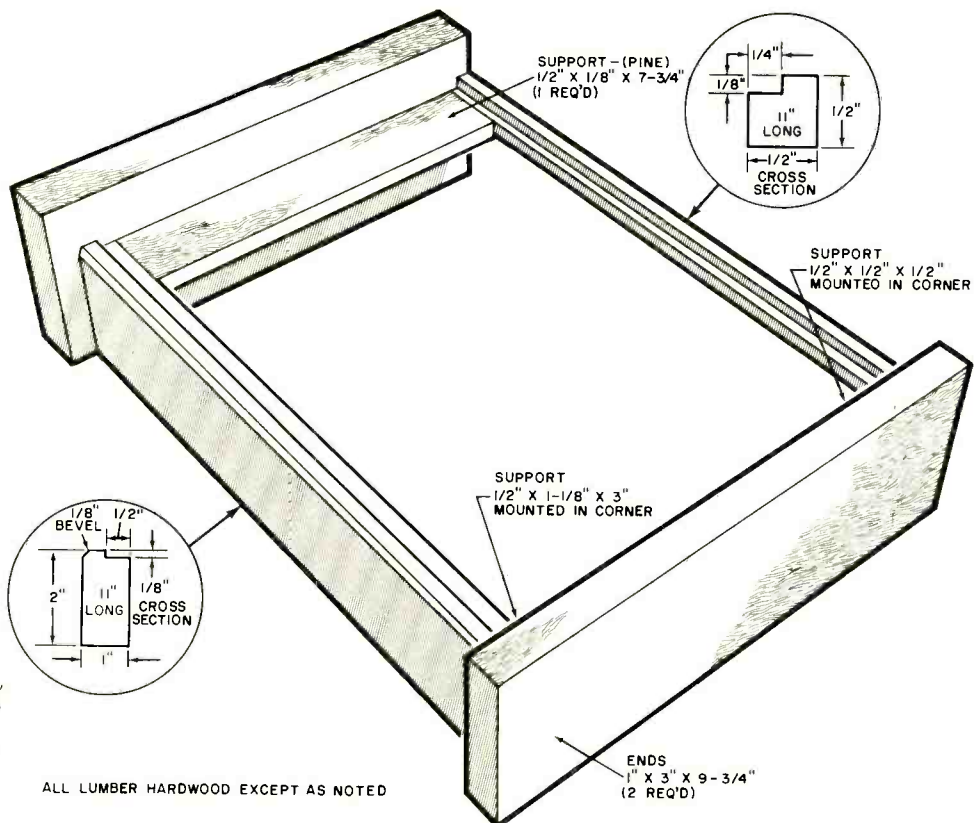

**Bill of Materials**

- 1—piece of Masonite 11" x 8 1/2" x 1/8"
- 2—pieces of hardwood 9 3/4" x 3" x 1"
- 1—piece of hardwood 11" x 2" x 1"
- 1—piece of hardwood 11" x 1/2" x 1/2"
- 1—pine support 7 3/4" x 1 1/8" x 1/2"
- 1—pine support 3" x 1 1/8" x 1/2"
- 1—pine support 1/2" x 1/2" x 1/2"

# FOR THE BEST CAR SPEAKERS AROUND THIS IS WHAT YOU SHOULD LOOK FOR.

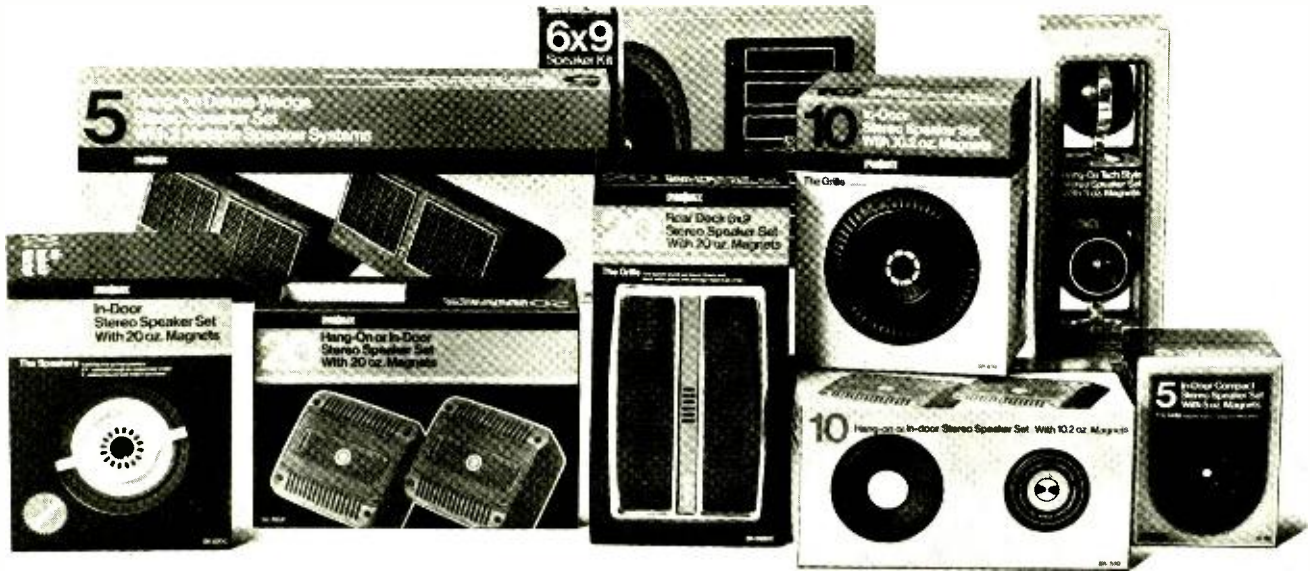

## AND THIS IS WHY.

For the past eight years we've had more speakers on the road than anyone else. So even though you may not have heard of the Sparkomatic name, you've probably been listening to the Sparkomatic sound.

Our SK-250 stereo speaker set undoubtedly helped make us number one. When we first engineered this "dual" speaker concept eight years ago, it was the only car speaker that could produce anything close to the high fidelity sound of home speakers.

Since then everyone's been trying to imitate us.

After breaking that sound barrier for the car, we soon went even further and engineered our coaxial speakers.

We mounted the woofer and the tweeter on the same axis (to deliver more natural bass and treble reproduction) and connected a capacitor crossover network to allow each speaker to operate at its peak level. Now our coaxial stereo

speaker line-up includes the SK-620C which is a trim in-door model, the SK-520C, an easy-to-



install hang-on and the SK-6920C, a rear deck mount designed to fit most existing rear deck cut-outs. All have twenty ounce magnets, well worth their weight to produce the best there is in car sound.

Our SK-355 stereo set is another example of Sparkomatic engineering know-how. We kept it small in size so it would be very much at home in compacts and mini imports. It has respectable five ounce magnets and air suspension cones so you can have big sound in small places. The SK-303 "tach" style speaker is also designed for small car application with the ease of hang-on installation.

No matter what size or price our speakers are, we put the same Sparkomatic expertise into everyone of them.

Like our SK-510 stereo speaker set. Moderately priced, yet, with

hard working ten ounce magnets and excellent range and delivery.

It's an easy hang-on installation. Or, if you're looking for the same characteristics in an in-door application, our SK-610 is the one.

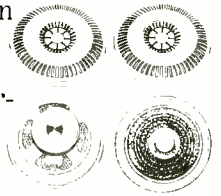

If you're still into monaural sound we have a wide range of individual high fidelity speakers. (We're perhaps the only company that does.) These rear deck speaker kits come complete with a dash mounted switch for adjusting the sound from front to rear or for a combination of both. They're available in two sizes, 6 x 9 and 5 x 7, and they fit the existing cutouts in the rear decks of most cars.

We make all of our speakers easy to install—most people do it themselves. All are quality engineered for every kind of car radio and tape deck there is. With Sparkomatic speakers you can fill your car with a world of sound that is comparable to what you hear at home. And now you know why Sparkomatic makes the best car speakers around.

# SPARK@MATIC

Sparkomatic Corporation, Milford, Pa. 18337, CB Equipment  Automotive Speakers  Car Radios  Competition Shifters  Mechanics Creepers

# TOOLS FOR ELECTRONICS EXPERIMENTERS

*Today's components and circuit designs  
require some special tools and techniques.*

BY A. A. MANGIERI

**T**ODAY'S hobbyist/experimenter must cope with many problems that never existed before the advent of printed-circuit technology, integrated circuits, and other microminiature devices. In the old days, you could get along with a set of screwdrivers, longnose pliers, diagonal cutters, and a soldering iron or gun. Now, without the aid of suitable tools, and technical aids, you will find it difficult—if not impossible—to build a complex IC project.

Printed circuit boards alone have created a number of problems. Special tools are required to cut the boards to size, drill numerous tiny

holes with bits that can't practically be chucked into a massive electric hand drill, and solder components without lifting the copper or scorching the board material.

Even solid-state devices place demands on tools that the old tool lineup can't begin to meet. Heat-sensitive, and now even static-electricity-sensitive, transistors and integrated circuits can be permanently damaged by old-fashioned tools. Obviously, then, you need special tools to work with modern electric devices and techniques. Some of these tools are highly specialized; but if you do a lot of experimenting, they'll pay for them-

selves. Other tools can be used for a broad range of jobs. The main point is that if you need a special tool for a given job, you can't make do as you could in the past.

First, let's review some of the basic tools every hobbyist/experimenter must have. Then we'll describe a few tools that aren't essential but will be great time savers when you do a lot of experimenting. Finally, we'll discuss how to judge tool quality to make your investment pay for itself in long tool life.

**Pliers and Cutters.** At the very minimum, you will need longnose

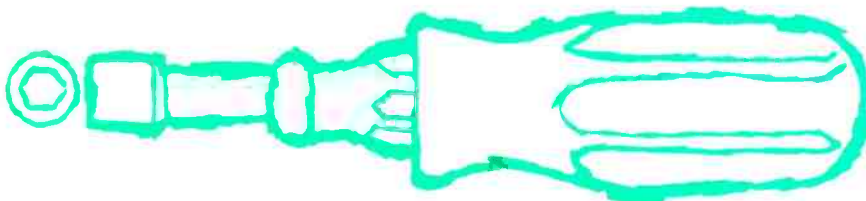

pliers, wire cutters, and slip-joint pliers. These three plier-type tools will see the most service in assembling kits and projects. Start with standard-size longnose pliers and diagonal cutters. Then, if you anticipate doing a lot of work with miniature components, you can add miniature longnose pliers and diagonal cutters. As your budget allows, you might consider adding tip-cutting, end-nipping, and round-nose and flatnose pliers. Each tool you add can be used for special types of jobs, and most are interchangeable.

One type of plier tool that most people in electronics often overlook is the plier-wrench, commonly called "vise-grips." Not only is this tool excellent for applying brute torque for turning bolts and nuts, it also can serve as a "third hand" for holding small parts, printed circuit assemblies, and small circuit assemblies. For a light grip, you close the jaws on the work by turning the adjusting screw. Used with C clamps



to serve as legs, the vise-grip plier will allow you to elevate and position the work as required.

Pliers should *never* be used on nuts and hex or square-head screws. At least that was the rule before Brookstone Co. came out with a plier specially designed for nuts. Resembling standard linesmen's pliers, this tool has two large sets of notches in its jaws that afford a slip-proof grip on nuts and screws.

The Brookstone, Jensen Tools and Alloys, etc., catalogs list several different kinds of plier tools of various



grades and functions. There are carbide-edged cutters, round- and box-nosed pliers, pliers with brass inserts in their jaws for mar-proof work,

and even pliers made from surgical steel. Needless to say, you don't need all—or even a majority—of the pliers and cutters mentioned, but if you add a few of the special items to your tool lineup, you'll find your project and kit building a great deal easier.



**Drivers and Wrenches.** A minimum list of screwdrivers should include  $\frac{1}{8}$ " (small with pocket clip),  $\frac{3}{16}$ ", and  $\frac{1}{4}$ " slot-type and No. 1 and No. 2 Phillips-type drivers. Although you won't have as frequent a call for them as for standard-size drivers, a set of jeweler's screwdrivers is generally inexpensive enough to include in your basic list. Many shaft coupler and control-knob setscrews and the hardware on variable capacitors, etc., are so tiny that only a jeweler's screwdriver is safe to use with them.

Much of the machine hardware in commercial electronic equipment and the setscrews in about half of all control knobs use hex-head hardware. For these, you'll need a hex-key set. You can buy a set consisting of individual keys, individual keys in screwdriver-type handles, and even in fold-up "jackknife" sets. Prices range from very inexpensive to relatively expensive.

Nutdrivers are used in electronics work almost as often as are screwdrivers. Nutdrivers are available in both solid- and hollow-shaft configurations, as individual drivers with separate handles, individual drivers that plug into a common handle, and separate sockets that plug into a universal handle/shaft combination. The least expensive and most convenient way of putting together a set of nutdrivers is to buy one of the plastic-cased assortments sold by such companies as Xcelite, Vaco, X-acto, etc.

Stubby nutdrivers, such as Xcelite's No. PS-120 set, are handy to have

when you must work in tight places; they even have an extra-large slip-on handle for increased turning torque. Large-size "nut" drivers for volume-control and rotary-switch hardware allow you to install the large hex nuts without the danger of marring the control panel. Supplement your nutdriver lineup with a set of miniature precision drivers. These are the nutdriver equivalent of the set of jeweler's screwdrivers.

Vaco has an interesting all-in-one self-adjusting nutdriver that fits hardware ranging from  $\frac{1}{4}$ " to  $\frac{7}{16}$ " (6.35 to 11.11 mm). You simply press the driver head against the nut to be driven, and the proper "socket" automatically fits over the screw. This tool can save lots of time that might ordinarily be wasted as you hunt through a separate assortment to find the right driver for a given nut. It also has the advantage of requiring the space of only a single driver in your tool kit.

You'll find that a 6" or 8" (15.2 or 20.3 cm) adjustable wrench will suffice for most of your nut and bolt turning operations. However, there always comes a time when your working space is so restricted that the adjustable wrench proves useless. In this case, you'll really come to appreciate an assortment of ratchet box wrenches. In general, you'll need only two ratchet wrenches  $\frac{1}{4}$ "- $\frac{5}{16}$ " and  $\frac{3}{8}$ "- $\frac{7}{16}$ " (6.35-7.94 and 9.53-9.94 mm). You can, of course, buy individual box/open-end wrenches, but there is really no call for the added expense and the space and weight they will take up in your tool kit.

**Soldering Equipment.** Although it's not the only method of mechanically and electrically assembling a circuit, soldering still ranks as the most practical for the great majority of assembly projects. Since most modern



electronic components are small and either heat-sensitive or static-electricity-sensitive or both, the most practical soldering tool is a low-wattage soldering iron or pencil with a grounded tip. (If you have, or anticipate having to do, heavy-duty solder-



ing, figure on buying a 100/140-watt dual-heat soldering gun.)

Your soldering iron or pencil should be rated at 25 to 50 watts, with a good average rating of about 35 watts. Make certain that it is UL approved for safety insurance. Modular soldering pencils, with separate power handles, heat elements, and soldering tips, offer maximum flexibility. They allow you to change heat-element cartridges and/or tips to suit the work in hand. And if any one piece goes bad, only that piece need be replaced, which adds up to good economy.

Soldering tips are available in raw copper, iron-clad copper, and nickel-plated copper. The raw-copper tip is the least expensive but is prone to rapid pitting and wear and must be replaced fairly frequently. The plated tips, although initially quite expensive, last a long time and need little maintenance to keep them in good condition. Needless to say, plated tips are more economical and less troublesome in the long run than are raw copper tips.

Soldering tips are also available in a wide variety of configurations, ranging from a blunt pyramidal shape to a wide chisel to a very fine needle-like point. The blunt tips are best for heavy-duty soldering, using a 50-watt heat element. For more general soldering jobs, a medium chisel-point tip on a 35-watt element is best. But when you're dealing with IC projects where foil traces on the printed-circuit board and the component leads are very close, a fine chisel or needle point is best to minimize the possibility of solder bridges.

A starter soldering tool should include a 30-to-35-watt heating element and medium-chisel and needle-point plated soldering tips. You can build up a heat element and tip assortment as the need for them arises.

Most soldering irons and pencils do not have the grounded tips required for safe soldering of static-electricity-sensitive MOS devices. (Ungar's "Condensed Line" does.) However, it's a simple job to ground the tip of any soldering iron. Tightly wrap around the tip—away from the working point—a strip of 20-to-24-gauge copper and fasten to it with machine hardware a length of heavy-duty stranded hookup wire. Terminate the free end of the wire at earth ground, using a cold-water pipe.

Although the great majority of soldering irons are designed to be used on line power, there are now available a number of cordless irons. These soldering irons are powered by built-in rechargeable nickel-cadmium cells, which allows them to be used anywhere, even when line power isn't available. The cordless irons have small tips that heat up rapidly (5 to 10 seconds) and provide 100 or more solder connections, depending on the sizes of the connections. Although the tips attain a high temperature, the relatively small heating unit and tip greatly reduce the chance of lifting fine copper traces and pads from pc boards. Most cordless irons are equipped with a built-in work light and offer a limited variety of tip configurations.

For electronics work, use only 60/40 (percentage of lead to tin) rosin core solder. Select 16-gauge solder for general-purpose and 18- or 20-gauge solder for fine pc work. When solder-



ing any semiconductor device or heat-sensitive component, heat sink the component leads with spring clips, longnose pliers, locking forceps or tweezers, or alligator clips. Keep handy soldering aids with pointed, slotted, chisel, and brush tips.

For removing solder from crimped connections and pc boards, you can use a rubber-bulb-type solder sucker or a plunger-type sucker. The latter is generally the more efficient tool, though it is also the more expensive. The most thorough device for removing solder is the solder "wick" made of

finely stranded untinned copper braid. When the wick is placed over a connection and heated, the capillary action, or "wicking," that occurs between the fine strands takes up virtually all solder and eliminates most of the risk of delaminating fine copper pads and lines on pc boards.

**Tools For PC Boards.** The wrong way to drill the fine holes required in pc work is with a standard hand-type power drill. You'll only succeed in breaking the fragile bits and possibly gouging the board. An excellent tool for drilling holes in pc boards is the Micro Electronics Systems Mini Drill that can be either AA-cell or line powered, the latter with an ac adapter. The tool accepts bits ranging from No. 80 to No. 54 (0.343 to 1.4 mm).

Another good tool for pc board work is the Dremel Moto Tool high-speed drill and grinder, which comes in



models ranging from the 0.5-ampere Model 260 to the heavy-duty variable 0.9-ampere Model 380. Light in weight, it is easy to manipulate and accepts drill bits ranging from No. 80 to No. 30 (0.129 to 3.26 mm), depending on which of three chuck collets are used. For maximum working convenience, you can convert the Moto Tool to a deluxe pc board drill press by mounting it in the No. 210 drill stand. Used in this manner, the Moto Tool will permit you to spot the bit on the smallest of copper pads with perfect accuracy.

An interesting new tool from Dremel is the Model 232 Moto-Flex, a high-speed drill and grinder with a 34" (0.86-m) flexible shaft and handpiece. This tool affords very precise control over hand-machining operations on the pc board. Its  $2\frac{3}{32}$ " (18.4-mm) diameter handpiece has ball bearings and accepts all Moto Tool collets and accessories.

With many accessories, these tools permit you to cut, score, or notch circuit boards using steel saws; cut off potentiometer and rotary switch shafts and screws with the cutoff

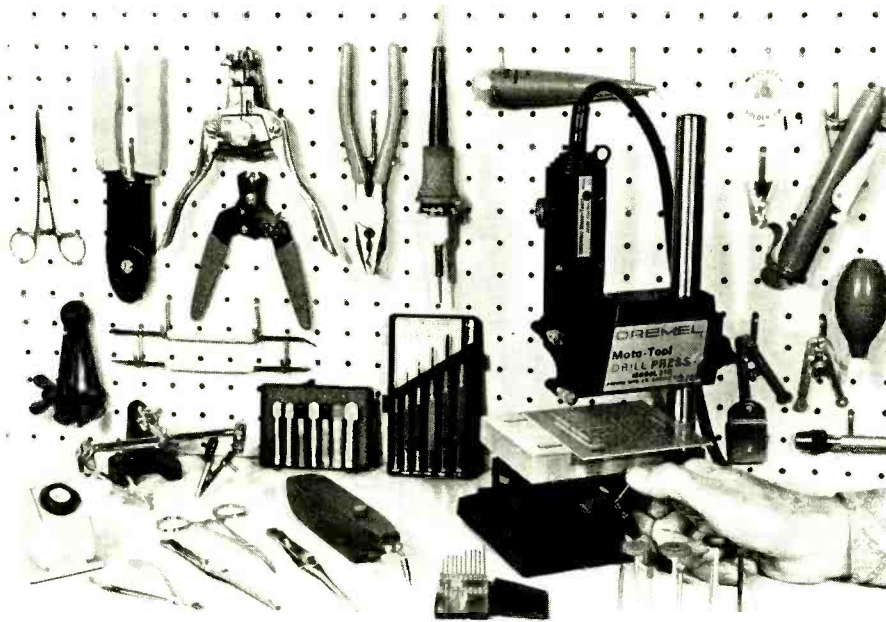

*Tools for a well-stocked electronics workbench. Both common and special tools ease project construction.*

wheel; and grind, debur, and polish other items. You can, for example, make inexpensive ground-plane boards using the No. 9909 router bit and Vector No. P138C circle pad cutter. (See "Perfboard Wiring Techniques," POPULAR ELECTRONICS, April 1976 for details.)

**Special Tools and Aids.** The fastest and lowest-cost perforated-board wiring method is with one of the wiring pencils, which eliminates wire cutting and stripping. You can interconnect any number of terminals with a single unbroken run and cut off the wire with the tip of the tool. You simply solder terminals through the insulation, which instantly vaporizes when heat is applied.

Automatic wire cutters/strippers, although rather expensive, can be a

real time saver when you have a lot of point-to-point wiring to do. These tools come with steel blades that do the cutting and stripping. If you don't mind first cutting your wires to size, one of the best strippers there is is the Alpha Model STRP-25 with plastic stripping blades. The plastic material is easily deformable to cut through insulation without nicking the wire. You can get thousands of strips from a single pair of blades. As the blades get used up on one size wire, they're still good for larger sizes. When the blades are finally used up, you simply inject new blades and start over again.

For holding and positioning pc boards and small electronic circuit modules, you can get a work-holding jig from X-acto or Brookstone. For detailed work, you'll want a work-inspection magnifier, preferably with a built-in fluorescent lamp, like the Luxo Model LFM-1.

You can easily damage the pins on DIP IC's when inserting or removing the devices from sockets. To play it safe, you can use either the GC Electronics No. 9481 Pul-N-Sertic insertion/removal tool or No. 9227 removal tool. For round transistors and IC's, use the No. 9216 Quick-Pick sleeve-type grippers from GC. (Incidentally, the Quick-Picks also serve as



**A Word About Quality.** Price and appearance are not always related to tool quality. High-grade hand tools are drop forged of various alloy tool steels, hardened and properly tempered. In the case of pliers, the tools should open smoothly and without erratic binding or looseness. Sight through and along closed jaws and cutting edges for proper alignment. Most pliers are made with the common lap-joint pivot that eventually loosens. You'll make a much wiser investment if you look for plier-type tools constructed with box-joint pivots that retain jaw alignment.

At all costs, avoid buying "bargain" pack tools or tools that are extremely low priced. Good and top-quality tools are rarely ever bargain priced; only tools that will fall apart or quickly wear out ever go on "bargain" racks. If you buy the latter, you'll only have to replace them in short order. It's better to buy the best when you can afford them than to build up a tool kit that will fail to do the job. A good rule of thumb is to stay with brand names that you know are of good quality. ♦

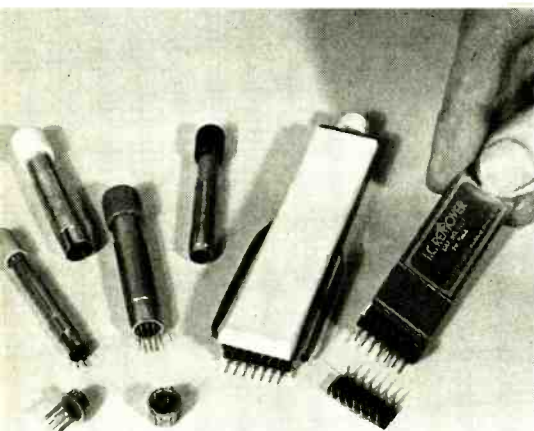

*GC Electronics Quick Pick Tools (left) and IC remover (right), with Pul-N-Sertic semiconductor inserter and remover (center)—all very handy.*



# The Big Stick.

# High, wide- ranging and handsome.

ENGINEERED FOR  
PRESENT 23 CHANNELS  
AND ADDITIONAL  
17 CHANNELS AUTHORIZED  
FOR USE AFTER 1-1-77

This half-wave, omni-directional fiberglass beauty punches out the big signal from 60 feet up to outperform all other base station antennas.

The Big Stick illuminates 12 times more capture area at 60 feet, sending the energy towards the horizon in a unique low angle radiation pattern.

Distributed dielectric loading, achieved by Shakespeare's exclusive fiberglass construction, enables the Big Stick to outrange taller, heavier metal antennas under all conditions.

Move up to the Big Stick. Pretuned. No ground radials. Works anywhere with any length cable. Also available in a lower cost model, Big Stick II. Shakespeare Industrial Fiberglass Division, P. O. Drawer 246, Columbia, South Carolina 29202.

Style 176

In Canada/Len Finkler, Ltd.,  
25 Toro Road, Downsview, Ontario

CIRC. # NO. 65 ON FREE INFORMATION CARD



*Shakespeare*

THE ROYAL LINE OF FIBERGLASS ANTENNAS

# Herb Laney's a tough-minded optimist. How about you?

Herb takes his future seriously. Without worrying about it. He knows his CIE training is giving him valuable skills in electronics. Skills a lot of people will be glad to pay for. And that's good reason for all the optimism in the world. How about you?

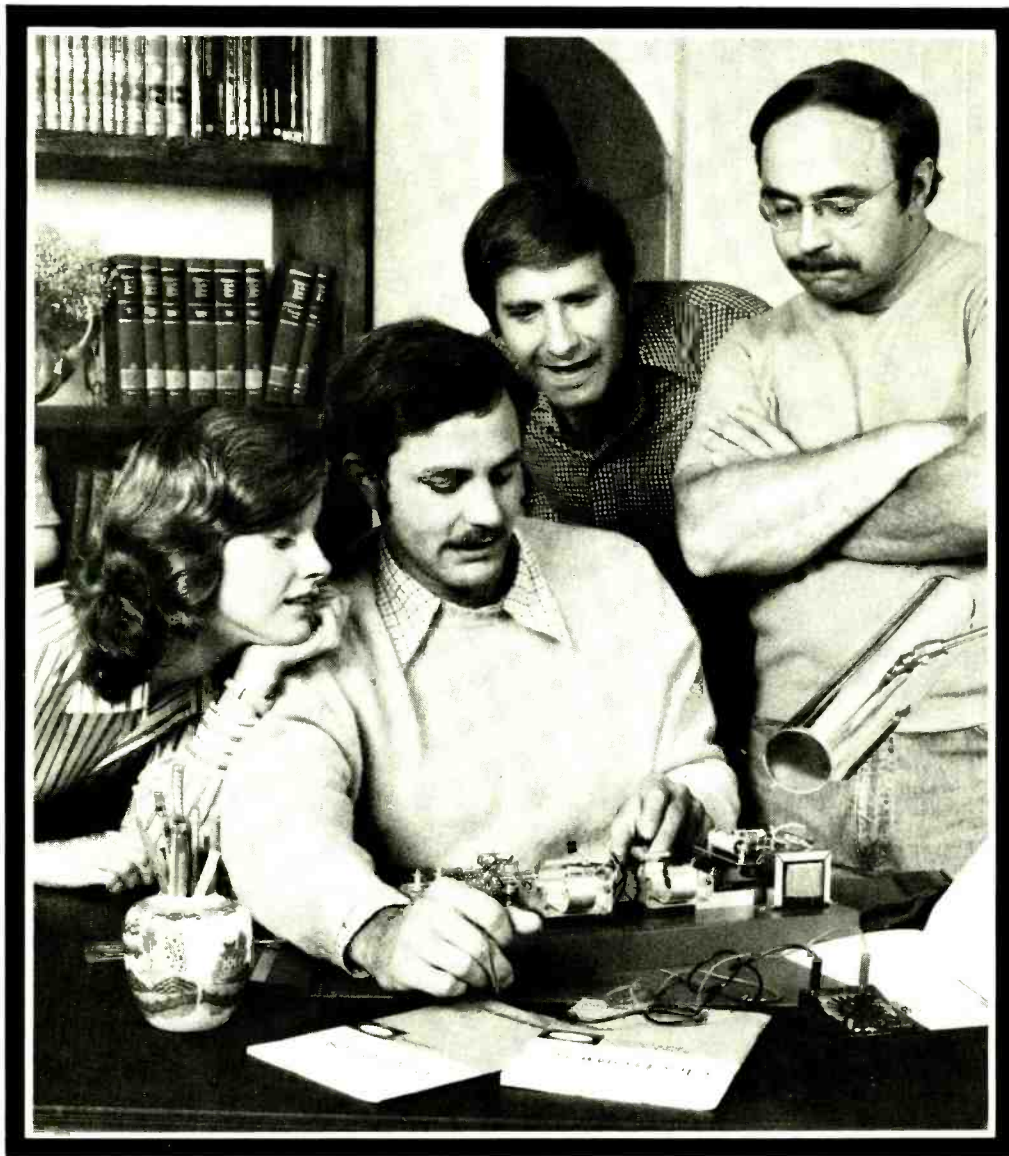

Learning new skills isn't something you just breeze through. Especially in electronics. You've got to really *want* success if you're going to build your skills properly.

Herb knew that right from the start. But he also knew what rewards he could earn if he took some time and did it right. He knew that, in today's world, people who really *know* electronics find a lot of other people... even whole industries... looking for their help.

How about you? How much do you want that thrilling feeling of success... of being in demand? Enough to work for it?

### Why it pays to build skills and know-how.

One of the things that got Herb interested in electronics is that electronics seems to be something just about *everybody* needs. Almost everywhere you look these days — in a business office... a manufacturing plant... a department store... a doctor's office... a college... even your own home you'll find all kinds of electronic devices.

That spelled "opportunity" to Herb. Plus he liked the idea of having a set of skills that might lead to jobs in places as different as a TV station... a hospital... an airport... a petroleum refinery.

But what Herb liked *most* about electronics is that it's just plain *interesting*. Even though it takes time and effort to learn, the subject is so fascinating it *almost* doesn't seem like "studying" at all!

### How CIE keeps you interested.

CIE's unique study methods do a lot to *keep* you interested. Since electronics starts with ideas... with principles... CIE's Auto-programmed Lessons help you get

the idea — at your own most comfortable pace. They break the subject into bite-size chunks so you explore each principle, step by step, until you understand it thoroughly and completely. *Then* you start to use it.

### How CIE helps you turn ideas into reality.

Depending on the program you choose, CIE helps you apply the principles you learn in a number of different ways.

If you're a beginner, you'll likely start with CIE's Experimental Electronics Laboratory. With this fascinating workbench lab, you actually perform over 200 experiments to help you grasp the basics! Plus you use a 3-in-1 precision Multimeter to learn testing, checking, and analyzing.

In some programs, you build your own 5MHz triggered-sweep, solid-state oscilloscope — and learn how to "read" waveform patterns... how to "lock them in" for closer study... how to understand and interpret what they tell you.

To help you develop practical, skill-building knowledge you then receive a Zenith 19" diagonal



solid-state color TV featuring nine removable modules. You learn how to trace signal flow... how to detect and locate malfunctions... how to restore perfect operating standards.

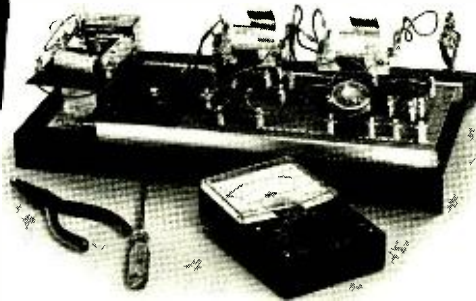

### What to do first.

Get all the facts. Send for CIE's FREE school catalog and career information package TODAY. Check *all* the CIE programs — and see which one's right for you. Do it now.

### Why it's important to get your FCC License.

More than half of CIE's courses prepare you for the FCC License exam. In fact, based on continuing surveys, better than 4 out of 5 CIE graduates who take the exam get their License!

That's important. For some jobs in electronics, you *must* have your FCC License. For others, employers often consider it a mark in your favor. It's *government-certified proof* of specific knowledge and skills!

### Free catalog!

Mail the card. If it's gone, cut out and mail the coupon. If you prefer to write, mention the name of this magazine. We'll send you a copy of CIE's FREE school catalog — plus a complete package of independent home study information! For your convenience, we'll try to have a representative call to help you with course selection. Mail the card or coupon... or write: CIE, 1776 East 17th Street, Cleveland, Ohio 44114.



OCTOBER 1976

## CIE Cleveland Institute of Electronics, Inc.

1776 East 17th Street, Cleveland, Ohio 44114

Accredited Member National Home Study Council

**YES**... I want to succeed in electronics. Send me my FREE CIE school catalog — including details about all electronics courses — plus my FREE package of home study information! PE-16

NAME \_\_\_\_\_  
 ADDRESS \_\_\_\_\_ (please print) APT. \_\_\_\_\_  
 CITY \_\_\_\_\_  
 STATE \_\_\_\_\_ ZIP \_\_\_\_\_  
 AGE \_\_\_\_\_ PHONE (area code) \_\_\_\_\_

Check box for G.I. Bill information:  Veteran  Active Duty

## Mail today!

# BUILD THIS LOW-COST CAPACITANCE METER

*Five linear ranges to 10,000  $\mu F$*



BY THOMAS MCGAHEE

**W**HEN a capacitor is connected to a constant-voltage source through a resistor, the charge on the capacitor increases *exponentially*. If the source supplies a constant current, however, the charge on the capacitor increases *linearly*. This linear charging principle is used here in the design of a capacitance meter which will measure values outside the range of most such meters. By using a constant-current source, the meter determines the time it takes to match the charge on the unknown capacitor to a known reference voltage. The meter has five full-scale ranges of 1,

10, 100, 1000, and 10,000  $\mu F$ . On the 1- $\mu F$  scale, values as small as 0.01  $\mu F$  can be read easily.

**How It Works.** As shown in Fig. 1, *D1, D2, R6, Q1* and one of the resistors (*R1* through *R5*) selected by *S1A* provide five decades of constant current. With *S2* in the position shown in Fig. 1, this current is shunted to ground via *S2A*. When *S2* is placed in its alternate position, the constant current will be pumped into the unknown capacitor connected across *BP1* and *BP2*, forcing it to charge in a linear fashion.

Op amp *IC1* is connected as a com-

parator, with its noninverting (+) input connected to *R8*, which determines the reference voltage. When the voltage developed across the unknown capacitor, connected to the inverting input (-) of *IC1*, becomes a few millivolts higher than the preset reference voltage, the comparator output will switch from +12 volts to -12 volts.

The output of the comparator drives a constant-current source consisting of *D3, D4, D5, R10, R11*, and *Q2*. When *S2A* was switched to ground, so was *S2B*. This action shorts across storage capacitor *C1*, therefore the voltage across this capacitor is zero.

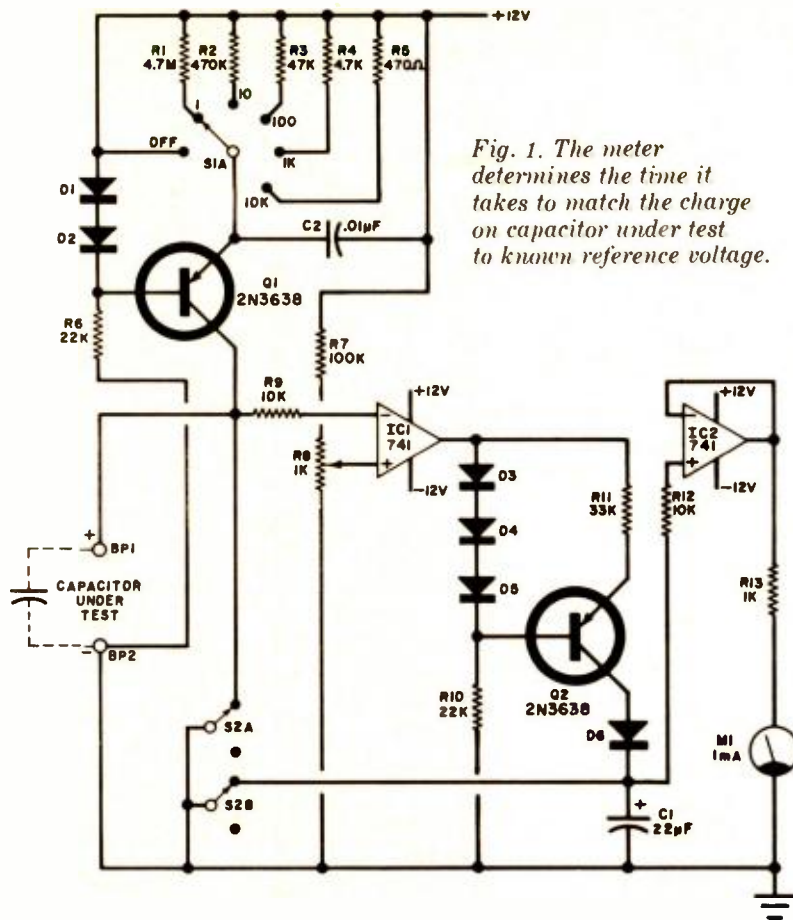

Fig. 1. The meter determines the time it takes to match the charge on capacitor under test to known reference voltage.

## PARTS LIST

- BP1, BP2—Five-way binding posts (one red, one black)  
 C1, C4—22- $\mu$ F, 35-volt electrolytic capacitor  
 C2—0.01- $\mu$ F ceramic disc capacitor  
 C3—220- $\mu$ F, 35-volt electrolytic capacitor  
 D1 to D6—1N914 diode  
 D7, D8—50-volt, 500-mA silicon rectifier  
 D9, D10—12-volt zener diode  
 IC1, IC2—741 mini-DIP case  
 M1—0-1-mA meter (Radio Shack 22-052 or equiv.)  
 Q1, Q2—2N3638 transistor  
 R1—4.7-megohm,  $\frac{1}{2}$ -w 5% resistor  
 R2—470,000-ohm,  $\frac{1}{2}$ -w 5% resistor  
 R3—47,000-ohm,  $\frac{1}{2}$ -w 5% resistor  
 R4—4700-ohm,  $\frac{1}{2}$ -w 5% resistor  
 R5—470-ohm,  $\frac{1}{2}$ -w 5% resistor  
 R6, R10—22,000-ohm,  $\frac{1}{2}$ -w resistor  
 R7—100,000-ohm  $\frac{1}{2}$ -w resistor  
 R8—1000-ohm, pc-type trimmer potentiometer  
 R9, R12—10,000-ohm,  $\frac{1}{2}$ -w resistor  
 R11—33,000-ohm,  $\frac{1}{2}$ -w resistor  
 R13—1000-ohm,  $\frac{1}{2}$ -w resistor  
 R14—560-ohm,  $\frac{1}{2}$ -w resistor  
 R15—470-ohm,  $\frac{1}{2}$ -w resistor  
 S1—Dp 6-pos. rotary switch (Radio Shack 275-1386 or equiv.)  
 S2—Dpst or dpdt pushbutton or rocker switch  
 T1—Transformer, secondary 12-V, 300 mA (Radio Shack 273-1385 or equiv.)  
 Misc.—Suitable enclosure (Radio Shack 270-627 or equiv.), line cord, insulated wire, spacers, rubber feet (4).

When S2 is opened, the constant current flowing into C1 causes the voltage across it to rise linearly. When the voltage across the capacitor under test causes the comparator to switch, diode D6 becomes reverse biased, preventing C1 from charging any more. Since C1 only charges until the comparator switches, the voltage generated across it is directly proportional to the capacitance value of the unknown capacitor.

To prevent C1 from discharging while measuring its voltage, a high-impedance buffer, formed by IC2, is used. While this buffer draws very little current, it does draw some, and this results in a very slow downward drift

of the meter—but this drift is actually too slow to cause any problems. Resistor R13 and meter M1 make up a simple voltmeter readout of approximately 1 volt full scale. If desired, an external voltmeter can be used as long as it has a full-scale range of less than 8 volts. (If you use such an external meter, set R8 on the 1- $\mu$ F range, so that a known 1- $\mu$ F capacitor indicates 1 volt.) Capacitor C2 is used to prevent oscillation of the Q1 constant-current source, while R9 and R12 protect the op amps in case the power is turned off while the test capacitor and C1 are charged, otherwise they might discharge via the op amps, causing damage.

The power supply whose circuit is shown in Fig. 2, can supply sufficient current to power the meter.

**Construction.** The circuit can be built on the pc board whose foil pattern is shown in Fig. 3, along with the component installation on the nonfoil side of the board. Be sure to observe the polarity of the two electrolytic capacitors and the various diodes. The IC's are identified by a notch code.

The prototype was assembled in a 6 $\frac{1}{4}$ " by 3 $\frac{3}{4}$ " by 2" plastic box having a metal cover. The cover was drilled to accept M1, range switch S1, switch S2, and the two binding posts (BP1, BP2). Note that a red binding post was used for BP1 as this side is to be connected to the positive lead of the capacitor under test. The line cord exits through a small hole in the side of the plastic box.

Meter M1 is linearly calibrated to 1 mA full scale. Carefully open up the meter and using press-on type, or other printing medium, mark the scale "MFD" or " $\mu$ F."

The accuracy of the capacitance meter depends on two factors; the

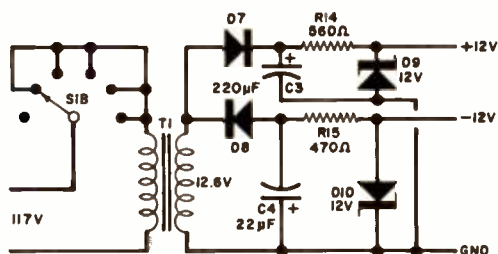

Fig. 2. Power supply delivers sufficient current for meter.

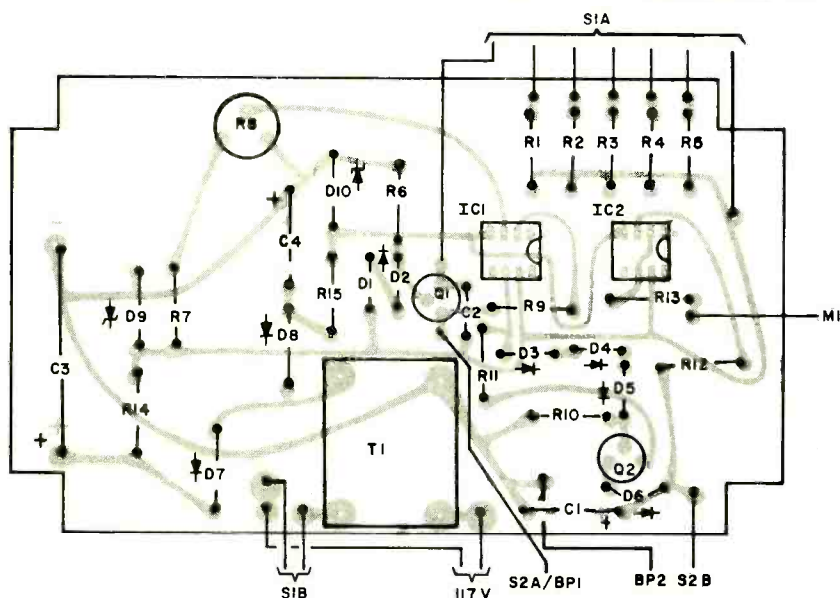
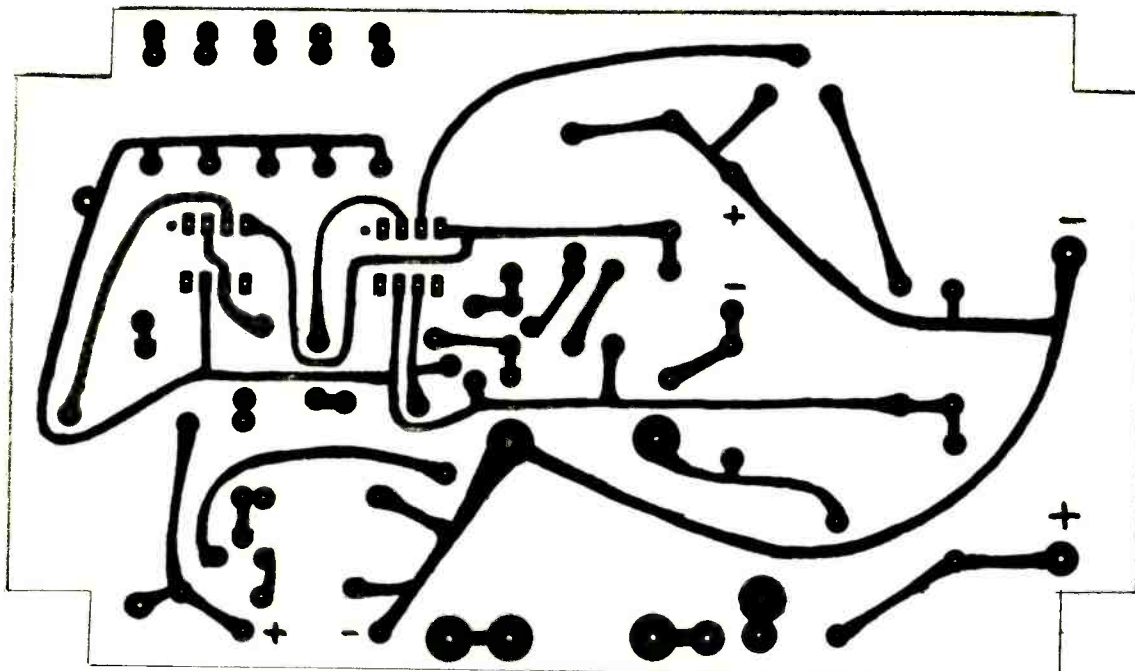

Fig. 3. Actual-size etching and drilling guide is above, component layout at left.

basic accuracy of the meter movement used and the accuracy of resistors  $R1$  through  $R5$ . In most cases, the meter accuracy will be 3%, and experience has shown that, with 5% tolerance resistors, the overall accuracy is about 3%. Although this may sound strange, it is due to the fact that most 5% resistors made by the same company tend to be off tolerance by the same percentage, thus reducing the effective percent error between the resistors. Using 10% resistors yields about 6% accuracy.

**Calibration.** Before applying power to the capacitance meter, use a small screwdriver to set the meter pointer exactly to the zero mark.

Select a capacitor between 0.5 and 1.0  $\mu\text{F}$  at 5% or better. This will be the "calibration standard." Connect this capacitor between  $BP1$  and  $BP2$  (positive side to  $BP1$ ). Set range switch  $S1$  to the "1" position (meter indicates 1- $\mu\text{F}$  full scale). Operate  $S2$  to remove the ground lead from the two circuits ( $Q1$  collector and  $C1$ ). The meter should start upscale and stop at some value. Reversing  $S2$  should cause the meter to drop to zero volts. Flip  $S2$  again and note the upscale value of the meter. Alternately flip  $S2$  and adjust  $R8$  until the meter indicates the exact value of the 5% calibration capacitor. The one calibration will suffice for all the other ranges.  $\diamond$

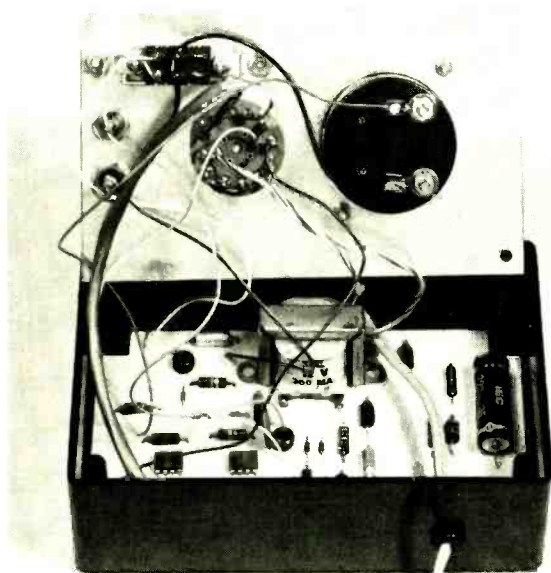

Photo shows how author's prototype was assembled in box.

# ATTENTION, DEALERS...

WE'RE SITTING ON THE LARGEST SELECTION OF

- ★ CBRADIOS
- ★ CB ANTENNAS
- ★ CB ACCESSORIES IN THE COUNTRY!



238 PAGES! THAT'S ONE OF THE BIGGEST CATALOGS IN AMERICA!

LITERALLY!

SEND \$5.00 FOR YOUR COPY OF OUR NEW

**238 PAGE CATALOG**

DEDUCTIBLE FROM YOUR FIRST ORDER!

...AND BENNIE'S ONE OF THE BIGGEST DISTRIBUTORS!



**Bennies Warehouse Distribution Center**

R. D. 1 — BERWICK, PA. 18603

PE-96

PHONE: 717 - 759-2201

OCTOBER 1976

CIRCLE NO. 12 ON FREE INFORMATION CARD

67

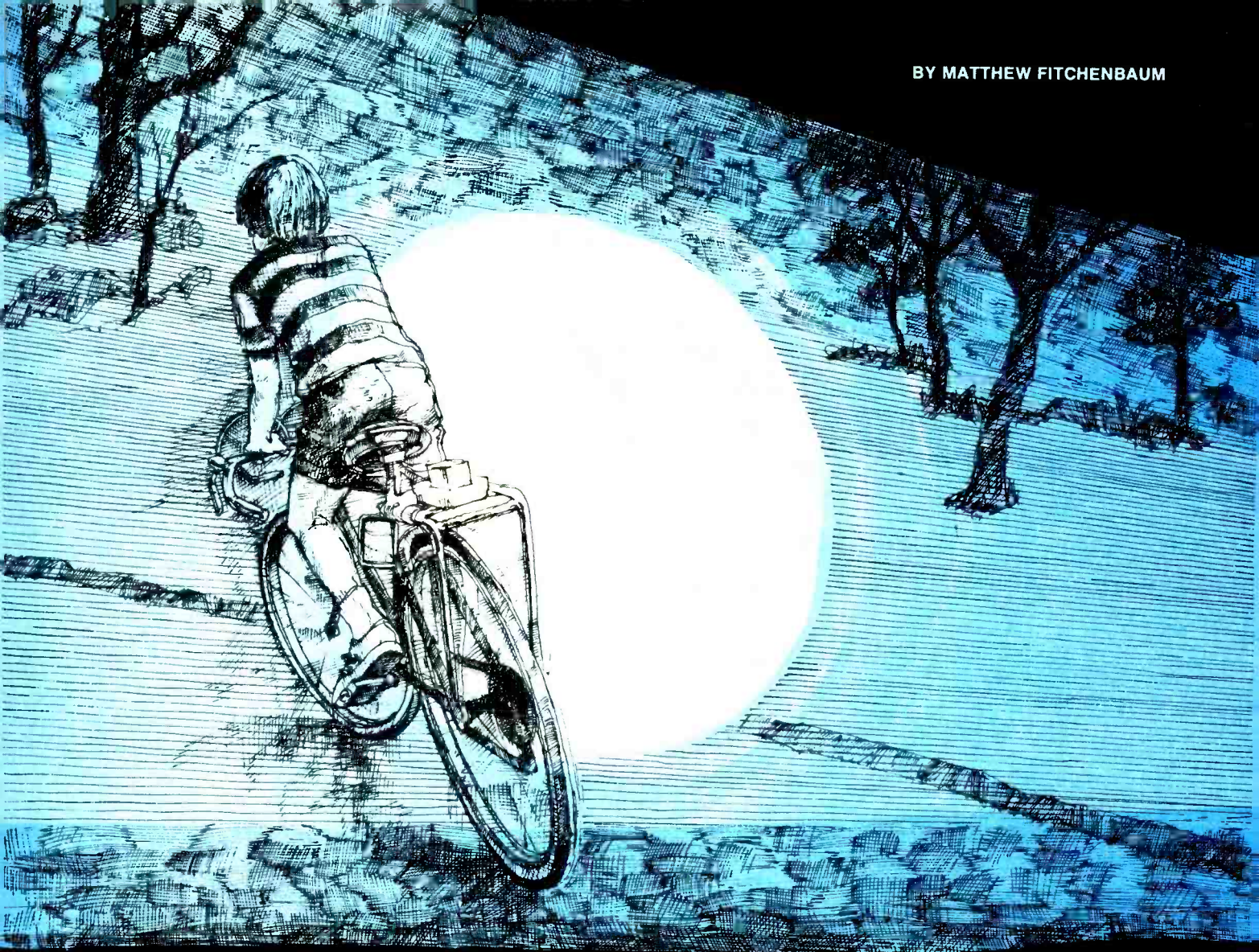

# A Strobe Flasher for Night Cycling

*Uses a high-voltage xenon flash tube and dc/dc converter.*

**A**LL BICYCLISTS and car drivers are aware of the need for visibility when riding a two-wheeler at night or in fog. However, providing a clear indication of a cyclist's presence can be a real problem. Blinking incandescent lights can be used, but they put out only small amounts of light. The light described in this article uses a xenon tube to generate a bright flash that can be seen from a great distance—but is not intense enough to destroy a driver's night vision. Simple circuitry allows the project to be built at low cost, in a lightweight, compact package that can be secured to the bicycle or the rider's belt.

**Principles of Operation.** The light-producing element is a sealed glass tube containing two electrodes and filled with the inert gas, xenon. When a high voltage is applied to the tube, the gas ionizes. That is, some of the electrons are stripped from the xenon atoms. When the electrons and xenon ions recombine, the energy that caused them to separate is given up as light. If many atoms are ionized, the light output is intense.

Xenon flash lamps are usually operated in a pulsed mode. The intensity of their flashes gives good visibility, and their short duration keeps the average power applied to the tube low. How-

ever, the flash tubes require high voltages. In this circuit, a dc-to-dc converter supplies this high voltage, drawing power from two AA batteries. A capacitor stores charge which is needed for the large instantaneous flash current. To initiate ionization in the tube, a potential difference of about 4000 volts is required. This is developed by a trigger coil, or pulse transformer, which steps up the converter output.

**About the Circuit.** Transistor *Q1*, transformer *T1*, and their associated components comprise an oscillator which is the heart of the dc-to-dc con-



verter. When power is first applied, collector current builds up until the ferrite core of *T1* saturates. At this point, base drive is removed from *Q1*, the transistor cuts off, and flux in the core decays. Then the cycle repeats itself again.

On the other side of *T1*, high voltage pulses developed across the secondary are rectified by *D1*, and charge *C2* to +250 volts. The voltage divider composed of *R2*, *R3*, and *R4* charges *C3* to 90 volts and *C4* to 200 volts. The time constants associated with these capacitors are small, so the voltages across *C3* and *C4* can be assumed to be proportional to that across *C2*.

When the potential across *C3* reaches approximately 90 volts, neon lamp *I1* fires and discharges *C3* through the gate of *SCR1*. This causes *SCR1* to turn on, and the charge stored in *C4* is dumped into the primary of *T2*, the trigger coil. Because of *T2*'s high step-up ratio, this surge of current induces a potential difference of several thousand volts across the secondary. In turn, the flashtube fires, creating a bright flash of light as the charge stored in *C2* flows through the tube. When *C2*'s charge is depleted, the tube stops conducting and goes dark. Then the rectified pulses from *D1* start to charge up the capacitors, and the cycle begins again.

The flasher requires only two or three volts to function. Two penlight (AA) cells make a lightweight power source, but since current drain is 250 to 300 mA, carbon zinc cells should be used only if the flasher is intended as a back-up safety device in extreme circumstances. However, two alkaline AA cells should provide about six hours of intermittent operation. If the flasher is to be used frequently, rechargeable nickel-cadmium batteries should be installed. They will give about two hours' use to a charge. (Of course, rechargeable or nonrechargeable C or D cells can be used if more extensive use is contemplated.)

Most of the components can be obtained from any electronic parts store, including flash tube *FT1* and trigger coil *T2*. However, the converter transformer *T1* must be wound on a Ferroxcube 2616-F1D bobbin and uses two Ferroxcube 2616-PL00-3C8 pot core halves. These parts are available from some industrial distributors, and a mail-order source is included in the parts list.

**Construction.** The flasher can be

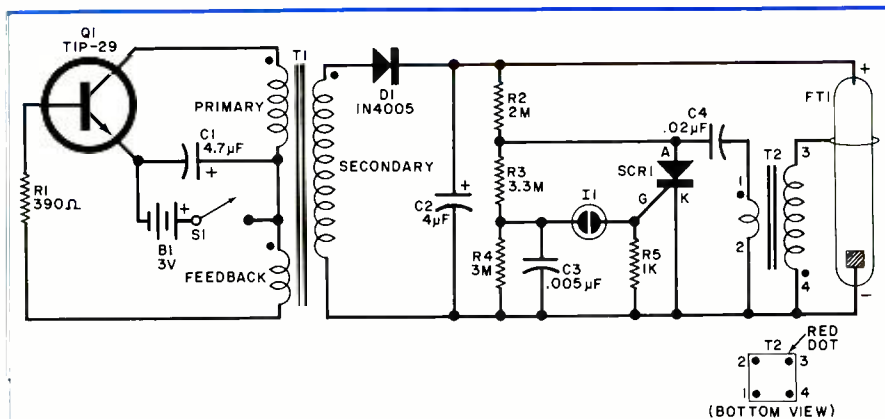

*Two 1.5-V batteries power the converter which drives the flashtube and SCR trigger circuit.*

#### PARTS LIST

B1—Two 1.5-volt cells in series (see text)  
 C1—4.7- $\mu$ F, 10-V electrolytic capacitor  
 C2—4- $\mu$ F, 450-V electrolytic capacitor  
 C3—0.005- $\mu$ F, 500-V disc ceramic capacitor  
 C4—0.02- $\mu$ F, 500-V disc ceramic capacitor  
 D1—1N4005 diode  
 FT1—Xenon flash tube (Radio Shack 272-1145 or equivalent)  
 I1—NE-2 neon bulb  
 Q1—TIP-29, HEP S5000 npn plastic power transistor or equivalent  
 The following are 1/4-watt, 10% tolerance resistors:  
 R1—390 ohms  
 R2—2 megohms  
 R3—3.3 megohms  
 R4—3 megohms  
 R5—1000 ohms  
 S1—SPST switch  
 SCR1—400-volt silicon controlled rectifier (Radio Shack 276-1000 or equivalent)  
 T1—see text  
 T2—4000-volt trigger coil (Radio Shack 272-1146 or equivalent)  
 Misc.—Printed circuit or perforated board, solder, hookup wire, No. 34 enamelled wire, No. 28 enamelled wire, machine hardware, circuit board spacers, suitable enclosure, battery holder, standoff insulator, silicone cement, solder, etc.

Note—The Ferroxcube 2616-F1D bobbin and two 2616-PL00-3C8 ferrite pot core halves are available for \$3.00 (first class postage paid) from Elna Ferrite Laboratories, Inc., Box 395, Woodstock, NY 12498.

built on a printed circuit or perforated board, and housed in any enclosure of sufficient size. The prototype was built in a small plastic box with a transparent top which protects the flash tube without obscuring its light output.

No matter which arrangement is chosen, the first step in constructing the flasher is to assemble *T1*. It is wound on a nylon bobbin that will be inserted into a two-piece ferrite pot core. Begin with the secondary. Allow a few inches of No. 34 enamelled wire to extend from a slot in the bobbin, and attach a "flag" of masking tape to the end of the wire. Mark the tape with an "S." This will allow you to keep track of the start of the secondary winding, which is essential to proper phasing. Secure the wire to the bobbin with a piece of electrical tape, and then wind 350 turns, keeping each layer even. When you have finished, cover the winding with electrical tape, and leave a few inches of wire free to serve as a connecting lead for the "finish" end of the secondary.

The primary will be wound next, using No. 28 enamelled wire. Use a masking tape flag marked "P" to identify the start of the winding, and wind 16 turns in the same direction as you

did for the secondary. When the primary is completely wound, cover it with a layer of electrical tape. As before, leave a few inches of wire free at both ends of the primary. Finally, wind the five-turn feedback winding in the same direction as the other two. Use No. 28 enamelled wire, identify the start of the winding with a tape flag marked "F," and cover the completed bobbin with a layer of electrical tape. Again, leave a few inches of lead length on each side of the winding.

Insert the bobbin between the two pot core halves, and mount the transformer on the project board using #6-32 machine hardware. The ferrite core is very brittle, so the mounting hardware should be no more than finger tight. Use a dab of silicone cement to secure the nut to the board.

The flashtube should be mounted so that it can be seen and is somewhat protected from shock. The author mounted his flashtube on the circuit board using its leads and a standoff insulator. Note that the electrode composed of wire mesh is the cathode. Trigger transformer *T2* should be positioned near the flashtube. The rest of the components can be mounted in any convenient

**NEWS RELEASE 1976** **OFFICIAL TESTING LAB RATES ALLISON #1... the BEST of ALL Ignition Systems!** **NEW ALLISON 'OPTO XR-700'** with the Exclusive... "Built-In" SOLID-STATE VOLTAGE REGULATOR

The ALLISON "Opto" was Officially Rated #1 by a Foreign Government Testing Laboratory as the BEST "Fuel Saving" Ignition of ALL the Ignition Systems Tested, including Systems with C.D. "add-ons"

Allison replaced the mechanical Breaker-Points and Condenser with a "Highly Accurate" Optical Control. A Beam of Light, passing through a specially designed "ROTOR" precisely triggers a Heavy-Duty "POWER MODULE" that BOTH "Charges and Fires" the Ignition Coil, with the "FASTEST" High Voltage RISE TIME, producing the MAXIMUM "HIGHEST ENERGY" SPARK available

Since there is NO Mechanical Friction, there are NO Parts to ever WEAR or need replacing, and ONCE properly Timed, it should NEVER need any Maintenance! DWELL never needs adjustment, it is PRE-SET to supply the OPTIMUM Performance at BOTH High and Low Speeds. The RPM Capability of the "XR-700" is Factory Tested to 15,000 RPM

The "High-Energy" SPARK INTENSITY and DURATION... permits the Positive FIRING of Spark-Plugs, even under the MOST ADVERSE conditions... results in more COMPLETE COMBUSTION and Eliminates "Engine Misfire", hence fewer exhaust Emissions, IMPROVED Fuel Mileage, a HIGHER Performance Level... and helps keep Plugs FROM FOULING, which greatly extends the Spark-Plug LIFE!

Only the Highest Grade (U.S. Made) Solid-State Components are used... UNAFFECTED by Moisture or Vibration! The Allison "XR-700" was engineered to OUTLAST the LIFE OF YOUR CAR!

"EASY-TO-FOLLOW" INSTALLATION. (Not Necessary to Dismantle your Distributor.)

"CB" USERS: The XR-700 completely ELIMINATES the Major Cause of Primary (Ignition Noise) Interference.

U.S. & Foreign Patents Pending

The "XR-700" is a NEW, redesigned, EASIER TO INSTALL version of the Allison "Opto-Electric", with the New addition of the Voltage Regulator, making it the MOST RELIABLE and Fool-Proof Ignition System ever invented.

"XR-700"... Designed for those who want the BEST in Performance, Gas Mileage, Quicker Starting, Eliminate frequent Tune-Ups and Maintenance Costs.

**FACTORY-BACKED 10-YEAR WARRANTY.** FREE Unit, Repair or Replacement on ANY Defects

**ORDER WITH CONFIDENCE...** Remember, even if you PAY Three Times as much, you cannot get a better Ignition System than the "XR-700"!

**SAVE! ORDER FACTORY DIRECT.** Send Check or M.O., Car Make, Year, No. Cyl. (4, 6, or 8-Cyl.)

You may use your MASTER CHARGE or BANKAMERICARD. Send us (1) Your Number, (2) Interbank No., (3) Exp. Date

MC or BA Card Holders, ORDER BY TOLL FREE PHONE: (800) 423-6525, Ext. 2. (When in Continental U.S.A.)

Before Buying ANY other Type Ignition System... **Send Postcard for FREE BROCHURE.**

If you have already installed a "Capacitive-Discharge" Ignition **Convert Your "C.D." Unit to BREAKERLESS! INCREASE ITS EFFICIENCY with "XR-CD"....Only \$34.95**

America's Oldest and Largest Manufacturer of Opto-Electronic Ignition Systems. ©

**ALLISON** Our BEST Salesmen...are the USERS of our ALLISON Systems!  
AUTOMOTIVE CO. 1267 -E8, East EDNA Pl., COVINA, CAL. 91722

CIRCLE NO. 6 ON FREE INFORMATION CARD

manner. It is wise to leave the transformer leads long, as a mistake in the direction of a winding, or improperly identifying the start of a winding, will require a phasing change involving the reversal of one or more windings.

### Checkout and Troubleshooting.

When you have completed building the project, double check all wiring, and then turn the unit on. The flashtube should flash about once each second, and an audible whistle should be heard near T1 as the dc-to-dc converter oscillates.

If no whistle is heard, measure the battery voltage and current with a high-impedance multimeter. If no current is being drawn from the battery, check the wiring to T1, Q1, R1, the battery, and switch S1. If current is being drawn, try reversing either the primary or feedback winding of T1, but not both!

The converter might oscillate but the flashtube won't flash. In that case, measure the voltage across C2. Although current is limited, the capacitor's voltage can give you an unpleasant shock, so be careful! A reading of 250 to 300 volts is normal. But if the voltage is below this level, disconnect R2 and the anode of FT1 from the positive plate of C2. If the voltage is now correct, the problem is located in the trigger circuit for the flashtube. If the voltage is low but not zero, try reversing the secondary winding of T1. Zero voltage points to incorrect wiring or a defective D1 or C2 component.

When the voltage across C2 is correct but there is no flash, the trigger circuit must be examined. Measure the voltage between the anode and cathode of SCR1. You should obtain a reading of 200 volts or so. If you do, short these two points with a jumper. The tube should flash as you do this. If it doesn't, either it or the trigger coil is defective. Other possibilities are a faulty SCR or trigger component (I1, etc.) or incorrect wiring of that part of the circuit that generates the trigger.

**Final Thoughts.** If desired, small leather straps can be secured to the flasher enclosure to serve as belt loops. The unit is small enough to be mounted either on the bicycle or on the cyclist's arm or leg. It can also be taken along for hikes on dark country roads. You will probably find many other applications for this handy little bicycle flasher. ♦

POPULAR ELECTRONICS

## FREE McIntosh CATALOG and FM DIRECTORY

Get all the newest and latest information on the new McIntosh Solid State equipment in the McIntosh catalog. In addition you will receive an FM station directory that covers all of North America.



### MX 113

FM/FM STEREO - AM TUNER AND PREAMPLIFIER

**SEND TODAY!**

McIntosh Laboratory, Inc.  
East Side Station P.O. Box 96  
Binghamton, N.Y. 13904  
Dept. PE

NAME \_\_\_\_\_  
ADDRESS \_\_\_\_\_  
CITY \_\_\_\_\_ STATE \_\_\_\_\_ ZIP \_\_\_\_\_

If you are in a hurry for your catalog please send the coupon to McIntosh.  
For non rush service send the Reader Service Card to the magazine.

CIRCLE NO. 42 ON FREE INFORMATION CARD

# FIND THE HIDDEN ELECTRONICS WORDS

**T**HERE are at least 59 electronics words, acronyms, or prefixes, hidden in the diagram at the right. You can locate them by reading forward, backward, up, down, or diagonally. They will always be found in a straight line, and no letters are skipped. The term "nano" has been circled to give you an idea of how to proceed. See how many of the known words or acronyms you can locate before you resort to the solution which is on page 105. If you find some that we didn't, good for you !

S X Z B A S E I X P A P E R C N R B A N  
M E G G Y D H W C A M P L I F I E D Z E  
X I R J O I A X O R Z I A X Q H I I D U  
W A C I X A M Q I A M P E R E R V P O T  
A C D A E L Z J D L Q L A X G N Z O H R  
V O L T V S Q V A L C A X D Q X A L J A  
C O L L E C T O R E I T O R O I D E O L  
H L L X W N M Q P L O E O C H W Z H A I  
R E C T I F I E R B O N A N C E Y Z M E P T  
E W E C V A Z Y S H A Q A F B Q A C M A  
S C R H D R E S O N A N C E Y Z M E P T  
I Q A B I A S F X J U H F W E G P A E I  
S H M X V D I A L Q H E R I G J C V D O  
T J I X K W Y L U M Z N E Q A N W E A N  
A O C A T H O D E D P R O Q T L R M N S  
N G C R Y S T A L T I Y U U L X V I C W  
C J C O A X V H W C Z O E U O Y A T E X  
E W L H I W A T T V X Q N B V C C T D E  
Z I Q M A L M I X E R G C H A N N E L F  
K E Y E D X P O W E R J Y H C A H R I J

BY THOMAS R. SEAR

## Faster and easier costs less when you build your own ACE.

**SPECIAL OFFER!**  
**\$5 OFF ON ACE 201-K!**  
**NOW ONLY \$19.95**

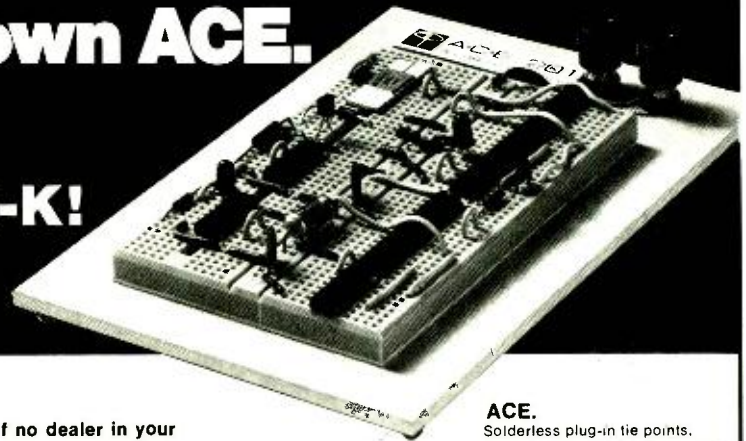

You know the advantages of ACE, the better solderless breadboards from AP Products. You know that there's no faster or easier way of building, testing, fudging and trying circuits and circuit ideas. But maybe you didn't know that two of our ACEs are available as kits. For people who don't mind taking a few minutes to make faster and easier less expensive as well. And when you order from this ad before November 15th, you can save an extra five dollars on our big 201-K.

If no dealer in your area, order direct.

**ACE.**  
 Solderless plug-in tie points, ground plane and binding posts.

Part No.	ACE Model No.	Tie Points	DIP Capacity	No. Buses	No. Posts	Board Size (inches)	Price Each	Qty.	Total
923333	200-K (kit)	728	8 (16g)	2	2	4-9/16 x 5-9/16	\$18.95		
923334	201-K (kit)	1032	12(14s)	2	2	4-9/16 x 7	<del>\$24.95</del> Special \$19.95		

\_\_\_\_\_ Credit Card Number

4 Numbers Above Name (MC) Good Thru \_\_\_\_\_

\_\_\_\_\_ Signature

\_\_\_\_\_ Print Name

\_\_\_\_\_ Address

\_\_\_\_\_ City \_\_\_\_\_ State \_\_\_\_\_ Zip \_\_\_\_\_

- Check or M O enclosed
- Charge BAC
- Charge MC
- Send catalog

Total for merchandise \_\_\_\_\_  
 Sales Tax (OH and CA) \_\_\_\_\_  
 Shipping (see table) \_\_\_\_\_  
**TOTAL ENCLOSED** \_\_\_\_\_

**Shipping/Handling**  
 Up to \$10.00 **\$1.00**  
 10.01 to 25.00 **1.50**  
 25.01 to 50.00 **2.00**  
 50.01 to 100.00 **2.50**  
 100.01 to 200.00 **3.00**

Orders subject to acceptance at factory.

Company PO's FOB Painesville  
 No COD orders

**DEALER INQUIRIES INVITED.**

**AP PRODUCTS INCORPORATED**  
 Box 110-H Painesville, OH 44077 (216) 354-2101 TWX: 810-425-2250





# Product Test Reports

## ABOUT THIS MONTH'S HI-FI REPORTS

*The ADC Accutrac 4000 is something completely different in record players—it's computerized! It combines a deluxe direct-drive record player with a microprocessor in a system that does some remarkable things in a totally "hands-off" manner. It even has full remote-control facilities. This player must be seen and operated to be believed.*

*Phono cartridges from Micro-Acoustics are unlike any other cartridges we know of in that they use electrets as transducing elements. The electret combines the advantages of magnetic and piezoelectric cartridges, with few of the disadvantages of either. The new Model 2002e cartridge is an updated version of the Model QDC-13 introduced a couple of years ago. Our tests proved it to be an outstanding cartridge in almost every respect.*

*The latest entry into the Phase Linear line of power amplifiers is the Model 200. This new "baby" amplifier is rated at a mere 105 watts/channel. It has the same styling, construction, and quality of performance of other Phase Linear products.*

—Julian D. Hirsch

## ADC ACCUTRAC 4000 RECORD PLAYER

*Microprocessor provides unique automatic control.*



The ADC Accutrac 4000 is the most unusual record player we have seen in years. In essence, it is a combination of the digital computer technology that made possible the electronic calculator and a deluxe direct-drive, two-speed record playing system. It comes with a high-quality tonearm that is fitted with a modified top-of-

the-line ADC Model XLM MkII phono cartridge.

On the front panel of the player's base is a row of 23 buttons similar to the keys on a calculator and four small rotary controls. The controls are for turning on and off the power, vernier adjustments of the 33 $\frac{1}{3}$ - and 45-rpm speeds, and setting the sensitivity of the player's unique sensor system. The buttons control all speed, record indexing, and track selection opera-

tions. In addition, the system comes with a remote-control facility that duplicates most of the controls on the player itself.

The Accutrac 4000 comes ready to play, mounted on a walnut base and with the cartridge installed. It measures 18 $\frac{1}{2}$ "W  $\times$  17 $\frac{3}{8}$ "D  $\times$  6"H (47  $\times$  44.1  $\times$  15.2 cm) and weighs 20 $\frac{1}{4}$  lb (9.2 kg). It sells for \$499.95.

**General Description.** The record player has 14 TRACKS buttons labelled from 1 to 13 and ALL. To play a disc from the beginning, the ALL button is pressed to start the platter revolving. (Normally, the player comes on at 33 $\frac{1}{3}$  rpm and is indexed for a 12" disc when power is applied. The buttons need not be touched unless 45-rpm discs are to be played or you desire to play tracks out of sequence.)

The control buttons have the light, positive tactile "feel" of the keys on a good pocket calculator. When the PLAY button is pressed, the tonearm moves to the lead-in groove of the disc, pauses, and slowly descends to the surface of the disc. After playing through to the end of the disc, the arm lifts and returns to its rest position, shutting off the motor.

Where the Accutrac 4000 differs from other record-playing systems is in its ability to allow you to play the various bands on a disc in any desired sequence and to repeat bands on command. When the PLAY button is pressed, the tonearm moves inward until it comes to the beginning of the first band selected, pauses for a few seconds, and lowers to the disc's surface. After playing the band, the arm lifts and returns to rest and again scans inward until it locates the beginning of the second band selected. The process repeats until all selected bands have been played. Then the player automatically shuts off.

The memory of the control system can store up to 24 program commands. Hence, bands can be repeated as desired up to a total of 24 times. Even the ALL button can be pressed 24 times, if that is what you want.

The REJECT button allows you to bypass any selection to go on to the following selection. The REPEAT button allows any selection being heard to be played again. If you wish to hear a band again from its beginning before it is ended, you press REPEAT and REJECT. The CUE button alternately raises and lowers the tonearm. (The audio outputs are muted whenever the

pickup is off the surface of the disc.) To stop play at any time, you press CLEAR, which wipes the memory clean and returns the tonearm to its rest position as before.

The manner in which the player locates the programmed bands is as intriguing as its control system. Built into the special Model LMA-1 cartridge are a LED and a photocell. The LED focuses an infrared beam on the record's surface, while the photocell intercepts the reflected light. The light is scattered by the grooves so that little of it reaches the photocell. However, the dead band between selections on the disc reflects sufficient light to the photocell to signal the computer circuits that the pickup has passed from one band to another.

The number of times the signal is received is compared with the information stored in the memory system. When the pickup reaches the beginning of the next programmed band, it stops and holds its position for a few seconds to average out any record eccentricities. The tonearm then descends to the record's surface. Since the dead bands can vary considerably in width from one disc to another, it may be necessary to adjust the sensitivity of the positioning system with the SENSOR control.

The system can also be played manually. When the tonearm is raised, it can be moved laterally, against some friction from the drive clutch, to any desired position. Pressing CUE then starts the turntable and lowers the tonearm. CUE can also be pressed while the arm is in its rest position, which then frees the arm to be moved and cued without resistance. ADC stresses that the tonearm is completely free while it is playing a disc because the servo-motor drive is disengaged by a clutch when the pickup is lowered.

Transparent and translucent discs cannot be played automatically because they do not reflect enough light to the photocell to trigger the automatic circuits. These discs must be played either manually or from the beginning in the ALL mode. Discs that have a raised and tapered rim can cause the pickup to overlook the first band and set down one track farther in than desired. If this occurs, it is necessary to make allowance for the fixed error when programming the mechanism.

The remote-control system is a unique feature of the Accutrac 4000

player. A small spherical optical sensor can be placed anywhere within 12' (3.7 m) of the turntable, into which it plugs. The small hand-held transmitter has buttons on it that duplicate all the TRACK and CONTROL buttons on the player itself. When the transmitter is pointed at the sensor and any button is pressed, a coded ultrasonic signal is sent to the receiver. The program is entered into the memory system, and a red light on the sensor winks to indicate that the command has been received by the system.

**Laboratory Measurements.** The turntable had the low rumble and flutter one would expect from a good direct-drive system. Rumble was 42 to 44 dB down unweighted and 62 dB down with ARLI weighting. Wow and flutter were each 0.04% unweighted rms. The speeds were exact when the built-in strobe pattern was stationary. They could be varied over a range of +2.6% to -2%. The speeds did not change when the line voltage was varied between 95 and 135 volts.

When set to the recommended 1-gram mark, the tonearm's tracking force measured 1.05 grams. The lateral tracking error was less than 0.5°/in. for radii between 3" and 6" (7.62 and 15.24 cm). It rose somewhat at smaller radii but remained within acceptable limits throughout the record area.

The antiskating dial had to be set considerably higher than the tracking force (typically 3 grams for a 1-to-1.5-gram tracking force) to provide equal playback distortion in both channels. The descent of the tonearm, under control of the cueing system, required 2 to 3 seconds. There was no lateral drift. The time required for the pickup to begin playing any selection after the PLAY button was pressed was about 7 seconds, almost half of it in the descent phase.

The cartridge was able to play most music records at a 1-gram tracking force without difficulty. The tracking at velocities exceeding 18 cm/s was poor at 1 gram. It was greatly improved by using the maximum recommended 1.5-gram force. At this low force, the IM distortion of the cartridge, at less than 2%, was about as low as any we have measured, even at the 27.1-cm/s maximum velocity of the Shure TTR-102 test record. The 10.8-kHz tone burst test of the Shure TTR-103 record indicated low distortion up to 20 cm/s and acceptable levels even at 30 cm/s.

Our other tracking test records (Fairchild 101, Cook 60, and German High Fidelity Institute) confirmed the importance of using a 1.5-gram tracking force. (On the German record, only the 60-micron band could be played at 1 gram, while the 80-micron band could be played at 1.5 grams.) The output of the cartridge was 4.1 mV on one channel and 3.55 mV on the other channel, measured at a 3.54-cm/s velocity. The vertical stylus angle of 28° was somewhat greater than we have measured on other cartridges. The bass resonance of the tonearm and cartridge was at 9 Hz at an amplitude of 9 to 10 dB. Since the cartridge is fairly massive, this indicates that the arm is commendably low in mass.

The frequency response of the cartridge was flat within ±1 dB up to 10,000 Hz. It rose at higher frequencies to about +5 to +6 dB at 20,000 Hz. Channel separation was an excellent 30 dB in the midrange and 12 to 15 dB at 20,000 Hz. When we played the Shure "Audio Obstacle Course—Era III" record, it was necessary again to use a 1.5-gram tracking force to enable the cartridge to track all sections except the highest level of the sibilance test.

**User Comment.** Our measurements

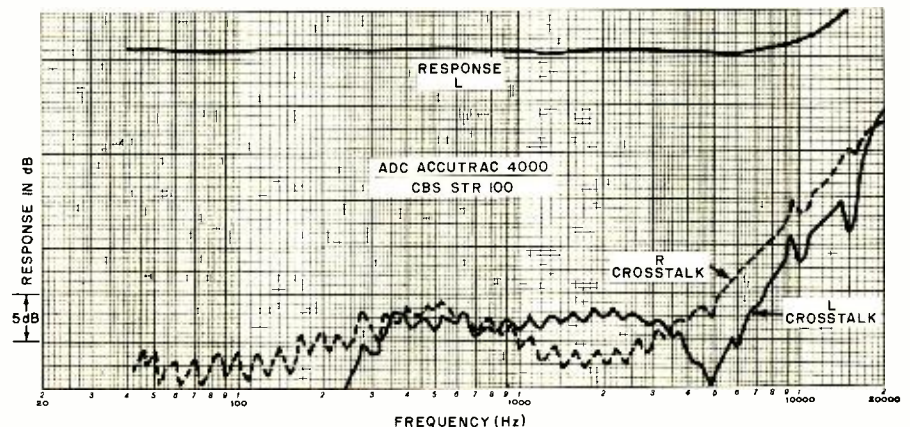

*Response of left channel and crosstalk in both channels.*

and listening tests confirmed the excellence of the Accutrac 4000 as a record player. The rising high-end response of the cartridge is not likely to be heard as a brightening of the sound. Most speaker systems are not strong performers in the uppermost octave, and many amplifiers lose 1 or 2 dB of top-end response in phono operation due to interaction with cartridge inductance. To our ears, the ADC cartridge sounded clean.

The computer control system worked exactly as claimed, exhibiting all the strengths and weaknesses pointed out in the instruction manual. We expect that with at least 95% of the

records we have seen, the optical track locating system will work perfectly. With most of the rest, only a simple readjustment of the SENSOR control will be required.

Since the tonearm need never be touched, especially when it is in a position to contact the record, it would seem well nigh impossible to damage a record with this player. Furthermore, the servo-controlled tonearm sets down more accurately and gently than would be possible by hand. The remote-control system also worked perfectly. The spherical remote receiver survived a 3' (1-m) drop to a concrete floor without suffering either

functional or physical damage.

If used properly, this record player can greatly enhance both the safety and convenience of playing records, with none of the compromises inherent in record changers or some other semiautomatic turntables. Considering what this player does, even the price is reasonable. A good semi-automatic, direct-drive player would cost at least \$300, and the ADC cartridge costs \$100. This means that with the Accutrac 4000, you get the computerized memory and remote-control systems for a mere \$100. All things considered, we feel this player gives good dollar value.

CIRCLE NO. 80 ON FREE INFORMATION CARD

## MICRO-ACOUSTICS MODEL 2002e PHONO CARTRIDGE

*Improved electret transducer features low cartridge mass.*

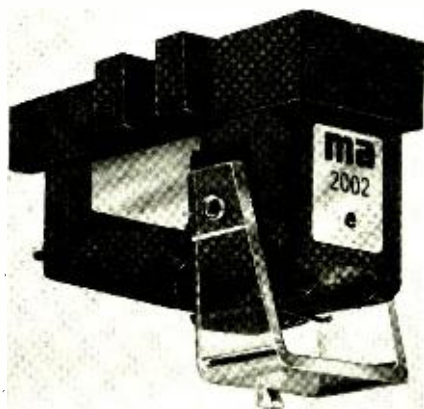

Cartridges from Micro-Acoustics are noted for their use of electrets as transduc-

ing elements. (The electret is a permanently polarized plastic capacitor whose capacitance is varied by mechanical flexing to produce a change in voltage across its terminals.) As used in the Model 2002e cartridge, the stylus cantilever is coupled to a pair of electrets as a "resolver" (yoke) so that stylus deflection by either stereo channel acts on only the corresponding electret.

The cartridge uses a beryllium stylus cantilever, which results in a very-low-mass, rigid moving system. Mounted on the free end of the cantilever is a  $0.2 \times 0.7$ -mil diamond stylus. Among the specifications for this cartridge are: frequency response within  $\pm 1.5$  dB from 5 to 20,000 Hz; 30-dB nominal channel separation at middle frequencies; and 3.5-mV/

channel output at 5 cm/s recorded velocity. The rated tracking force is 0.7 to 1.7 grams. Any load resistance from 10,000 to 100,000 ohms and capacitance from 100 to 1500 picofarads is satisfactory.

The retail price of the cartridge is listed as \$115.

**General Description.** As with ceramic elements, the electrets used in the cartridge are amplitude-responding devices and have very high electrical impedance. Loading with a relatively low resistance—on the order of a few thousand ohms—reduces the cartridge's output voltage to that of a typical magnetic cartridge and converts its amplitude response to a velocity response. This makes the cartridge fully compatible with the input requirements of any magnetic phono preamplifier.

One of the advantages the electret has over the magnetic system is its inherently low mass. Since there is no heavy magnetic structure, the stylus is not required to move a piece of magnetic material. Because the cartridge has no internal coils, magnets, or pole pieces, it weighs much less than the typical magnetic cartridge. In fact, extra plastic had to be added to the cartridge's housing so that it could be balanced by existing tonearms. Nevertheless, the cartridge's 4-gram weight is considerably less than that of the magnetic cartridge, which usually weighs about 7 grams.

Several other advantages result from the use of the electret. With no coils, the cartridge is not susceptible

to magnetic hum pickup. Although the very high impedance of the electret might appear to make it subject to electrostatic hum induction, it is internally loaded with a 4000-ohm resistor so that hum can be induced only when the finger lift is being touched on tonearms that have unshielded heads for the cartridge.

The frequency response of the cartridge is virtually unaffected by external loading, including long signal cables. Unlike most magnetic cartridges, which rely on coil inductance and load capacitance to compensate for the high-frequency resonance of the generating system and to flatten the frequency response, the Model 2002e achieves its flat response by reducing moving mass. This places the resonance far above the audible range. Mechanical damping is built into the cartridge to control the resonant rise.

Finally, it is claimed that the constant load presented to the amplifier input reduces high-frequency noise in the phono system. (The impedance of a magnetic cartridge rises with frequency and can cause an emphasis in high-frequency noise.) Also, the purely resistive output impedance of the cartridge cannot interact with preamplifier equalization to modify its

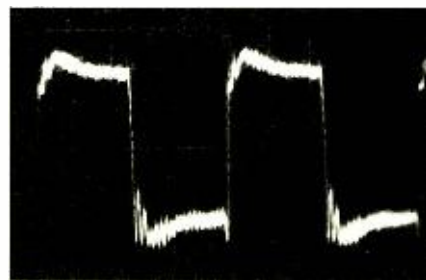

*Output from square-wave test.*

high-frequency response, as occurs with most magnetic cartridges and amplifiers.

**Laboratory Measurements.** Using the CBS STR100 test record, we plotted a frequency response of within  $\pm 1$  dB over the 40-to-20,000-Hz range of the record for the new cartridge. The channel separation measured 20 to 25 dB at the middle frequencies, 15 to 20 dB at 10,000 Hz, and 5 to 8 dB at 20,000 Hz. The output of the cartridge at 3.54 cm/s was 3.25 mV on one channel and 2.8 mV on the other channel. The vertical angle of the stylus was  $20^\circ$ , which is the industry standard.

We played a number of high-velocity test records to determine the optimum tracking force for the cartridge. Under most conditions, 1 gram was sufficient; at this force, the 70-micron level of the German Hi-Fi Institute record could be tracked. However, at 1 gram tracking force, the IM distortion measured with the Shure TTR-102 test record was slightly high, between 1.5% and 3% up to about 19 cm/s. It rose abruptly at higher velocities, where the cartridge mistracked. An increase to a 1.2-gram force allowed the cartridge to track all levels of this record, with distortion typically about 1% up to 25 cm/s and only 2% at the record's maximum of 27.1 cm/s. The 80-micron level of the German record was playable at 1.2 grams tracking force.

The 10,800-Hz tone-burst tracking test of the Shure TTR-103 record revealed low distortion even at 1 gram (only 1.7% at 30 cm/s), but an increase to 1.2 grams dropped this to a very low 1% figure. These tests were confirmed subjectively with the Shure "Audio Obstacle Course—Era III" record. At 1 gram, there was slight mistracking of the highest levels of the sibilance and

bass-drum sections, but at 1.2 grams, the cartridge tracked the entire record without difficulty.

Tests with the CBS STR112 test record produced a good square-wave output, with low-level ringing visible over most of the top of the waveform. The ringing occurred at about 35,000 Hz, which is the mechanical resonance of the moving system. This is about an octave higher than that of most other fine phono cartridges. With the cartridge installed in the relatively massive tonearm of a Philips record player, the low-frequency resonance was in the safe 7-to-8-Hz region. (Many cartridges resonate as low as 6 Hz in this tonearm.) In a widely used Dual record player, the resonance was at 9.5 Hz, an almost ideal frequency. These measurements clearly illustrate the advantage of low cartridge mass, since tracking of warped records can be severely impaired by a tonearm resonance below 7 Hz or so.

**User Comment.** The Model 2002e is an improved version of Micro-Acoustics' Model QDC-1e cartridge, which it replaces. The principal changes inherent in the new cartridge are an increase in stylus compliance and reduction of its moving mass (beryllium is used instead of aluminum for the cantilever) and reduction of the total mass of the cartridge.

Having used a Model QDC-1e for some time, we were in a good position to appreciate the improvement in the Model 2002e cartridge. The new cartridge tracks at a slightly lower force than its predecessor's 1.5 grams. The Model 2002e can actually be used with excellent results at 1 gram, where it is the equivalent of the Model QDC-1e operating at 1.5 grams. However, we feel that an increase to 1.2 grams is

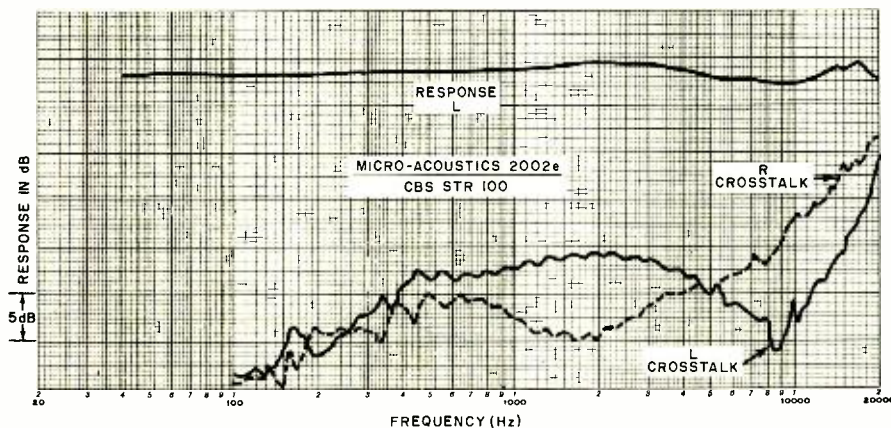

Left-channel response and left and right crosstalk.

The Best Way To Show You What You'll Get Out Of An Empire Phono Cartridge Is To Show You What Goes Into One.

At Empire we make a complete line of phono cartridges. Each one has slightly different performance characteristics which allow you to choose the cartridge most compatible to your turntable.

There are, however, certain advantages, provided by Empire's unique design, that apply to all our cartridges.

One is less wear on your records. Unlike other magnetic cartridges, Empire's moving iron design allows the diamond stylus to float free of its magnets and coils, imposing much less weight on your record's surface and insuring longer record life.

Another advantage is the better channel separation you get with Empire cartridges. We use a small, hollow iron armature which allows for a tighter fit in its positioning among the poles. So, even the most minute movement is accurately reproduced to give you the space and depth of the original recording.

Finally, Empire uses 4 coils, 4 poles, and 3 magnets (more than any other cartridge) for better balance and hum rejection.

The end result is great listening. Audition one for yourself or write for our free brochure, "How To Get The Most Out Of Your Records". After you compare our performance specifications we think you'll agree that, for the money, you can't do better than Empire.

Empire Scientific Corp.  
Garden City, New York 11530

**EMPIRE**

Already your system sounds better.

worthwhile, since it makes the Model 2002e one of the best tracking cartridges on the market.

The flat response and low distortion of the new cartridge are outstanding. The channel separation is more than adequate, although it does drop off considerably at the very high frequencies. We listened carefully to the audible amplifier hiss with this cartridge and several fine magnetic cartridges with inconclusive results. When the

gain was set for equal volume from both cartridges, the hiss was sometimes less with the Model 2002e, sometimes, the same, but never was it greater than that of the magnetic cartridges that we tested.

We were struck by the total absence of hum pickup. Hum is not always audible as such, but with magnetic cartridges, it is usually present to the extent that its removal can be detected.

All in all, the sound of the Model

2002e cartridge was smooth and unstrained. The cartridge can track just about anything on today's records at 1.2 grams and will play warped records that might prove too much for some cartridges in a given tonearm. Finally, the cartridge is *quiet*. Even at the highest listening levels, lifting the tonearm from the record results in total silence from the speaker systems driven by most good amplifiers.

CIRCLE NO. 81 ON FREE INFORMATION CARD

## PHASE LINEAR MODEL 200 BASIC POWER AMPLIFIER

*High-quality, moderately high power at "popular" price.*

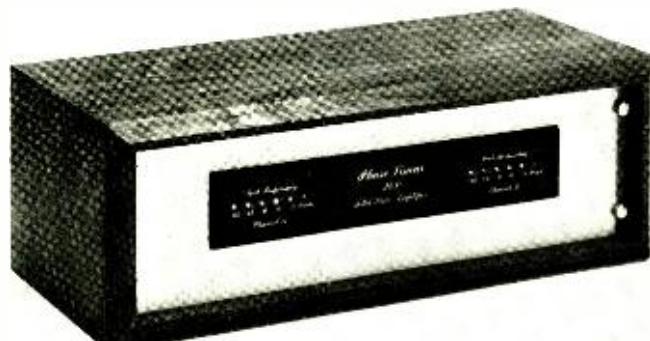

Phase Linear's high-power audio amplifier technology, as used in the Mod-

els 400 and 700 amplifiers, has been applied to a more popular price and power range in the new Model 200. The new amplifier is rated to deliver 105 watts/channel with both channels driven into 8-ohm loads from 20 to 20,000 Hz at less than 0.25% total harmonic distortion (THD). A signal level of 1.5 volts across the 18,000-ohm input drives the amplifier to its rated output power. The output transistors are protected by current-limiting circuits, and a fast-acting relay disconnects the speaker systems during start-up and turn-off and in the event of an internal failure that could damage the speakers.

The amplifier matches the styling of other Phase Linear amplifiers. It has a light colored brushed-gold front panel that measures 19"W x 5½"H (48.3 x 14 cm). Overall depth is 8¾" (22.2 cm), much of which is taken up by the large heat-sink fins. The power transformer is at the right rear, but the lightweight 16-lb (7.3-kg) amplifier prevents the off-center weight distribution from causing handling problems.

The retail price of the Model 200 amplifier is \$389.00.

**General Description.** On the left side of the rear apron are insulated spring-clip connectors for hooking up the speaker systems, two phono-jack inputs, and two slide switches. One switch is for increasing the sensitivity of the LED power display on the front panel by 10 dB. The other switch is identified as a VELOCITY FEEDBACK switch with NORMAL and IN positions. According to the instruction manual that comes with the amplifier, the IN position reduces the current feedback in the amplifier by some 5 dB and raises the overall gain by the same amount. (Phase Linear's only explanation for this feature is that "some listeners may prefer" to hear sound with less feedback.)

Across the center of the front panel is a plastic-covered cutout about the size of the dial window of a tuner. Its only apparent purpose is to provide a means for placing the identification "Phase Linear 200 Solid State Amplifier" on the unit. On each side of the window is a graduated peak-responding power indicator system made up of six LED's for each channel. The LED's are labelled PEAK, -3, -6, -9, -12, and -20 dB. PEAK corresponds to the maximum rated power of 105 watts or to 10.5 watts if the SENSITIVITY switch on the rear apron is set to its -10 dB position. The manual

gives the power equivalents (across an 8-ohm load) for each channel for the other LED's in the display. The table contains some inconsistencies—the sensitivity increase is given as 10 dB for the two highest levels and 6 dB for the others—but the LED's are adequate for monitoring the approximate power output of the amplifier.

**Laboratory Measurements.** When we operated the amplifier at one-third its rated power for an hour, it became quite hot to the touch. However, this did not affect its operation. Fully heated, the amplifier delivered 162 watts/channel at the clipping point into 8-ohm loads with both channels driven simultaneously at 1000 Hz. The 16-ohm output power was 100 watts, and the 4-ohm output power, due to the current-limiting circuits, was measured to be 115.6 watts.

The 1000-Hz THD was about 0.01% or less at most power levels between 0.1 watt and 75 watts. It reached 0.02% at the rated output and 0.25% at 140 watts output. The IM distortion was between 0.01% and 0.05% from a few milliwatts to the rated output power. It was 0.24% at 130 watts.

At the rated 105-watt output, the distortion was well below 0.1% from 20 to 20,000 Hz. It measured about 0.02% at most frequencies. At reduced-power outputs, 3 and 10 dB down, it was even less, measuring typically about 0.01%. An input of 0.52 volt drove the amplifier to a reference 10-watt output, where the hum was a very low -93 dB, referred to 10 watts. When velocity feedback was switched in, the gain increased so that about 0.38 volt at the input produced a 10-watt output, but the noise level rose slightly to -82 dB. The distortion was only slightly affected by the feedback change. The gain of the left channel, on which these measurements were based, was 1.4 dB greater than in the right chan-

POPULAR ELECTRONICS



# THERE IS NO QUESTION

## Our computer is a bore—

There is simply no point in trying to hide it, everyone is going to find out sooner or later anyway. The Southwest Technical Products 6800 computer is a big bore. Discussions with customers and dealers have confirmed our worse suspicions.

At first people thought that perhaps owners of our system were just a bit shy because they were outnumbered at local computer club meetings. But then as the number of owners rose it became clear that this was not the problem. And it wasn't that they were unsociable or anything like that; they were simply just bored because they had nothing to talk about.

Here they were, just sitting there while all the other members with other brands of computers exchanged data on circuit board errors, secret schemes of adding extra bypass capacitors to make the thing reliable, tricks to keep the clock phases from overlapping, corrections to manual errors and other fun subjects. Can you imagine the frustration this caused? All our customers could do was to sit and be bored. They had nothing to talk about.

Our 6800 has an internal monitor ROM that automatically puts the bootstrap loader in memory and refers control to the terminal, when you power up. This feature deprives you of the chance to tell sad stories of how many

times you had to go back and flip the console switches before you got the loader program in right. Since you can do machine language programs directly from your video terminal or teletype in hexadecimal form, you will not have a chance to exchange horror stories with your friends about how you forgot the last zero when you entered 10100110 from the console on your 374th Byte and messed up the program that had just taken you two hours to put into memory. It just isn't fair.

Since we use full buffering on all data, address and control lines on all boards in our system and since we use low power 2102 static memories in our system, there are no noise sensitivity problems that can lead to hours of fun trying to figure out why a program "bombed". Dynamic memories that some others use can drop bits, fail to refresh random cells, cause programs to do crazy things by going into a refresh cycle at the wrong moment and all kinds of interesting things. Our poor customers will never have a chance to have these interesting experiences.

Even our documentation and software is no help. Not only do we have the most complete and thorough set of instructions available for any system, we are supplying software either free, or at crazy low prices. Our big documentation notebook for instance

is just full of information on the system. There are complete sections on software with sample programs and information on programming. We have no assembly instructions in that big yellow notebook. They are packed with the kits themselves. The notebook is completely devoted to instruction on using your computer system. You are therefore not going to be spending day after jolly day trying to find out how to put a program into your machine; researching all available outside literature in an attempt to discover just how you write software for the beast. Sorry about that folks, we didn't mean to spoil all your fun.

So please, have a heart, when you see those poor lonely souls that have purchased our systems say "hello". All they have to keep them interested in computers is writing and running programs. Our editor, assembler, 4K and 8K BASIC programs work so well that even this is quick and easy. So be kind to those poor bored SwTPC-6800 owners, it's not their fault that they have nothing to talk about.

**SWTP 6800**  
Computer System

with serial interface and 2,048 words  
of memory. . . . . \$395.00



- I don't like puzzles anyway and have no free time to be bored so send information on your 6800 computer system and peripherals.
- Thanks for warning me. Send names of manufacturers of "interesting" computers.

NAME \_\_\_\_\_

ADDRESS \_\_\_\_\_

CITY \_\_\_\_\_ STATE \_\_\_\_\_ ZIP \_\_\_\_\_

Southwest Technical Products Corp., Box 32040, San Antonio, Texas 78284

# EXCITING NEW PRODUCTS IN

## NEW!

### REMOTE TOUCH-SWITCH WITH ON-OFF-DIM CONTROL

Adds low-cost lighting versatility anywhere in your home. Provides on-off-switch control for incandescent lamps to 150 watts, from anywhere you choose! Eliminates the bother and expense of wall boxes, extra outlets and rewiring. Consists of a control unit you plug into an AC outlet (plug lamp into control unit) and a touch-plate you mount anywhere by means of a fine wire. Then simply touch for instant half-bright, hold for full-on, and touch again for off. Kit GD-1187, only \$12.95

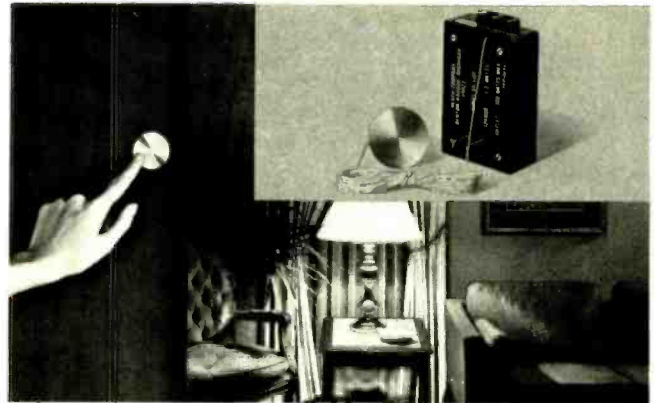

## NEW!



### PORTABLE ELECTRONIC MEGAPHONE/YELPER

Make yourself heard above the crowd! This power megaphone provides a full 20 watts voice power and a useful yelp alarm that really gets attention. Battery operated for use anywhere. Kit GD-1818, only \$79.95



## NEW!

### DELUXE AC VOLTMETER

The one you NEED for audio servicing and it's the only one we know of that gives you LINEAR voltage and dB scales. Measure phono cartridge, amplifier and tuner outputs, power supply ripple and noise, audio generator outputs, gain, line voltage, much more. Easy to use and accurate.

Kit IM-5238, only \$89.95



## NEW!

### TOTAL HARMONIC DISTORTION ANALYZER

Offers professional-quality at a super low price! Accurately measures harmonic distortion to as low as 0.03%, so you can check state-of-the-art amplifier specs, maintain peak performance from amplifiers and receivers. Features an automatic null circuit, usually found only on analyzers costing \$1000 and more, and a built-in AC voltmeter. Kit IM-5258, only \$219.95



Prices and specifications subject to change without notice.

# THE FREE HEATHKIT CATALOG

**NEW!**



**"SHIRT POCKET SIZE" COLOR ALIGNMENT GENERATOR**

The TV "service shop" you take with you anywhere! Provides 16 different display patterns — horizontal and vertical lines, crosshatch, dots, rainbow and gated rainbow, even a raster — for complete, thorough color TV convergence and alignment. Has crystal-controlled chroma and RF carriers and master timer, special battery-saver circuit for extra efficiency. Kit IG-5240, only \$64.95



**NEW!**

**DIGITAL CLOCK-INDOOR/OUTDOOR THERMOMETER WITH ALARM**

Two of our most popular and practical kits combined in a single, handsome unit. Full-feature electronic clock with alarm and snooze button; an accurate indoor/outdoor temperature indicator with a special alarm that sounds if the temperature goes above or below a preset temperature. Includes cables for custom mounting the temperature sensors just about anywhere. Kit ID-1490, only \$124.95



**FREE!**

Read about these and the nearly 400 other kits you can build yourself for fun, savings and satisfaction in the new Heathkit Catalog.

**SEND COUPON TODAY!**

Heath Co., Dept. 10-22, Benton Harbor, MI 49022

**NEW!**



**INTERMODULATION DISTORTION ANALYZER**

Measures IMD as low as 0.01% (plus residual) so you can use it to test and service the most modern audio equipment. Offers specifications and performance comparable to units costing far more. Use with the IM-5258 and 5238 for a complete, professional audio service center. Kit IM-5248, only \$169.95

HEATH	
<b>Schlumberger</b>	
Heath Company, Dept. 10-22 Benton Harbor, Michigan 49022	
Please send me my FREE Heathkit Catalog. I am not on your mailing list.	
Name _____	
Address _____	
City _____	State _____
GX-326	Zip _____

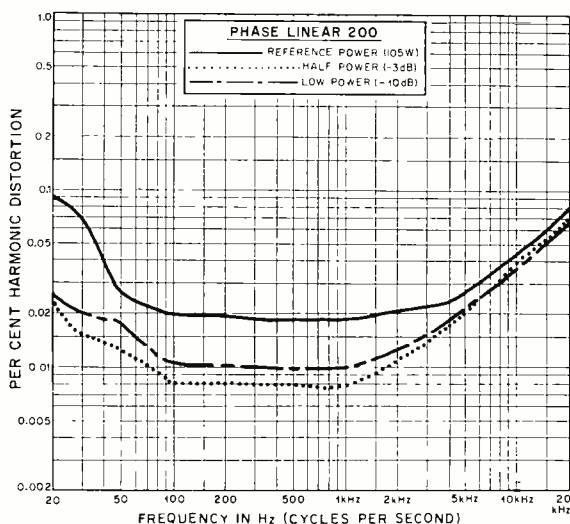

Harmonic distortion vs frequency.

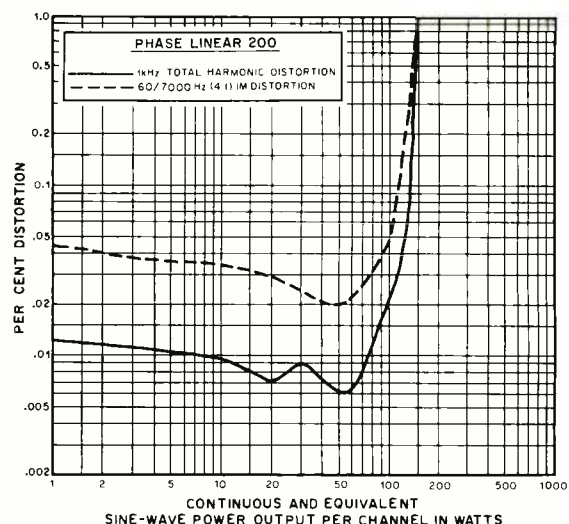

Distortion vs power output.

nel. There are no gain adjustments. The low-level frequency response was flat from our measurement limit of 5 Hz to beyond 10,000 Hz, dropping to -0.9 dB at 100,000 Hz and to -3 dB at slightly beyond 200,000 Hz. The square-wave risetime was 1.5  $\mu$ s (rated at less than 1.7  $\mu$ s). Paralleling a 2- $\mu$ F capacitor across the 8-ohm load produced a single cycle of ringing on the square wave, at a frequency of about 50,000 Hz.

The peak power indicators came on rather gradually so that it was difficult to decide when a LED was on or off. In spite of this uncertainty, we found the LED's to be fairly accurate, with the PEAK indicator coming on at 109 watts and the others within 2 dB of their calibrated levels. The -10-dB switch actually increased the sensitivity of the display by about 5 dB.

The protective relay provided a time delay of several seconds when the amplifier was turned on before it connected the speaker systems to the outputs of the amplifier. It worked well on ordinary overloads, such as shorted speaker outputs, but when we attempted full-power operation at frequencies beyond 20,000 Hz, the line fuse blew before the relay acted. When we shut off the amplifier, the relay dis-

connected the speaker systems instantly, preventing any transient thumps from reaching them.

**User Comment.** In spite of its light weight and compact dimensions, this amplifier proved to be very powerful and conservatively rated. Its 140 and 160 watts of actual, as opposed to rated, output power over most of the audible range should be enough for most people, even when fairly inefficient speaker systems are connected to the amplifier.

The protective relay encouraged us to use the amplifier to drive some small bookshelf speaker systems that were rated at much less peak power than the amplifier can deliver. In use, the speaker systems were never subjected to excessive levels during any normal switching operation. (Phase Linear recommends, and we concur with, fusing the speaker system lines if the speakers are not rated to handle the full output power of the amplifier.)

The power-indicator LED's rarely glowed; even peak powers are not likely to exceed a few watts with such speaker systems at normal listening levels. However, their presence served as a constant reminder to prevent us from turning up the volume too far. We

always expected to see the center panel between the display indicators light up when we turned on the power; but in normal operation, there is no pilot light or other indication that the amplifier is "live." Obviously, we would like to see a power lamp installed behind the cutout window to provide some indication when power is turned on.

So far as we could tell, this amplifier was as free from any characteristic sound quality as the Phase Linear Model 400 amplifier, which we have used for some time. In fact, we doubt that one could distinguish between the two at any power level within the capability of the Model 200.

We experimented with the VELOCITY FEEDBACK switch. Except for a small change in gain, we could hear no difference when it was switched in and out of the system.

This amplifier permits the audiophile of modest means to enjoy the benefits of Phase Linear's justly deserved reputation for clean, undistorted, and powerful sound. With its matching companion Model 2000 preamplifier from Phase Linear, it makes an attractively styled high-quality amplifying sound system.

CIRCLE NO. 82 ON FREE INFORMATION CARD

## PACE MODEL 145 AM CB TRANSCEIVER

Mobile rig features two extra channels for weather.



**T**HE Pace Model 145 crystal-synthesized 23-channel CB transceiver offers two additional receiving channels for monitoring U.S. Weather Bureau broadcasts on 162.400 and 162.550 MHz. This mobile rig has all the usual features: Delta tuning, r-f and audio gain controls, squelch, S/r-f meter, automatic noise limiter (anl),

# IMSAI announces a unique 4K RAM board for just \$139.

Nobody has a 4K RAM board that gives you so much for your money. It's fully compatible with the Altair 8800.

Through the front panel or under software control, you can write protect or unprotect any 1K group of RAM's. Also under software control you can check the status of any 4K RAM board in 1K blocks to determine whether it's protected or not. The board has LED's that clearly show you the memory protect status of each 1K block and which block is active. And there's a circuit provided that will let you prevent the loss of data in the memory if there's a power failure. This low power board has a guaranteed 450 ns cycle time—no wait cycle required. There's nothing like the IMSAI 4K RAM board around.

Dealer inquiries invited.

## IMS

IMS Associates, Inc.

IMS Associates, Inc.  
14860 Wicks Boulevard  
San Leandro, CA 94577  
(415) 483-2093

PE-10

Order Your IMSAI 4K RAM Board For Only \$139. Use BankAmericard. Master Charge, personal check or money order.

- Send \_\_\_\_\_ 4K RAM boards today.
- Charge to my credit card
- BAC No \_\_\_\_\_
- MC No \_\_\_\_\_

Signature \_\_\_\_\_

Name \_\_\_\_\_

Address \_\_\_\_\_

City/State/Zip \_\_\_\_\_

noise blanker (NB), PA operational mode, external-speaker jacks, and receive and transmit indicators. It is designed to operate from a nominal 12-volt dc, negative- or positive-ground, power source. Built into the dc power input circuit are reverse-polarity protection and a line filter.

The transceiver measures 10"D × 7½"W × 2¼"H (25.4 × 19.1 × 5.7 cm). It retails for \$239.95.

**General Description.** A double-conversion design is employed in the receiver section. One of six crystals in the 16.965-to-17.215-MHz range, depending on the CB channel to which the transceiver is tuned, is used to provide a first i-f of between 10.000 and 10.040 MHz. The second conversion is to a 455-kHz i-f, using one of four crystals in the 9.545-to-9.585-MHz range.

The diode-protected r-f stage is followed by two mixer stages. Then, i-f selectivity is obtained with a 455-kHz ceramic filter, which is followed by two i-f stages, the first of which is bandpass coupled. A voltage-doubling detector is followed by the audio anl circuit. The agc circuit is a voltage-doubling affair that also activates the squelch. The audio section ends up with the usual class-B power-output stage that doubles as the modulator for the transmitter.

The noise blanker picks up the impulse-noise pulses from the output of the first mixer and uses the pulses to gate the input of the i-f section by means of a diode switch.

The appropriate r-f and mixer circuits are provided for reception of the Weather Bureau broadcasts. The weather channels are labelled wx1 and wx2 and come equipped with 50.6166- and 50.5666-MHz crystals. These crystal frequencies are tripled for heterodyning to provide a first i-f of 10.7 MHz, which is then mixed with a 10.245-MHz crystal-controlled signal to produce a 455-kHz second i-f.

The signal is then set up for best clarity by operating the Delta-tune control to place the second i-f signal at the side of the ceramic filter curve that permits "slope" detection of the FM signal. The standard CB antenna is used for reception of the Weather Bureau broadcasts.

On transmit, the required 17-MHz synthesizer crystal signal is mixed with one of four crystal signals in the 10.000-to-10.040-MHz range to provide the on-channel carrier. Spurious

responses are minimized by bandpass circuits following the transmitter mixer. Buffer, driver, and power-output amplifier stages make up the rest of the transmitter section. The output circuit consists of a triple-section filter for matching to 50-ohm loads. Included in the filter section is a TVI trap.

Transmit/receive antenna change-over is performed electronically with a diode switch. Automatic modulation control (amc) takes over the gain of the audio section.

**Test Results.** Our measurements indicated a receive sensitivity of 0.5 μV (as rated) for 10 dB (S + N)/N when using a 1000-Hz test tone with 30% modulation. The maximum sine-wave audio output at the start of clipping was 3 watts at 10% THD, using the 1000-Hz tone and an 8-ohm load.

Unwanted spurious-signal rejection was a minimum of 50 dB, except in the area of 24 MHz, where it measured 30 dB. Image rejection was greater than 60 dB. Adjacent-channel rejection and desensitization were nominally 40 dB on the low and 60 dB on the high sides, which indicates the possibility of an assymmetrical shape of the ceramic filter's response or the response of the bandpass circuits. The overall 6-dB audio response was 350 to 3500 Hz.

The agc held the audio output to within 10-dB with a 20-dB r-f input change at 1 to 10 μV and to 14 dB with an 80-dB r-f variation at 1 to 10,000 μV. The S meter registered S9 with a nominal 100-μV r-f input signal. The range of the squelch control was from 0.35 to 400 μV.

We did not measure the sensitivity on the weather channels, but the manufacturer rates it at 2 μV for 20 dB (S + N)/N. This translates to less than 1 μV for a 10-dB ratio. During our listening tests, we obtained fine reception over a wide signal radius.

Operating the transceiver from a nominal 13.8-volt dc source, we measured a carrier output of 4 watts. Sine-wave modulation was available up to 100% with 7.5% THD. The amc had little control over preventing overmodulation, resulting in heavy squaring of both positive and negative peaks. Using a 1000-Hz test tone and raising the speech level by 10 dB above that required for 50% modulation slightly overmodulated the transmitter, with adjacent-channel splatter down 50 dB. Similarly, a 15-dB increase deteriorated the splatter figure to 40 dB down. Splatter with nor-

mal voice operation was 45 to 50 dB down. The overall frequency response at the 6-dB points was 550 to 5000 Hz, and the r-f tolerance on any channel was within 0.002%.

**User Comment.** This transceiver is nicely styled in its black case accented by a brushed-aluminum front panel and chromed control knobs. Miniature toggle switches are used for switching between the PA and CB operational modes and for engaging and

disabling the noise blanker. (According to the schematic diagram, the anl is also simultaneously switched in when the noise blanker is engaged.) The effectiveness of the noise-suppressing circuits was slightly below what we have come to expect.

A separate control knob is used for selecting any of the 23 CB or two weather channels. Indicators identify which mode is in use. The frequencies for the wx1 and wx2 weather channels are listed at the rear of the manual that

accompanies the transceiver. In most cases, only one of these channels can be received in a given region.

The S/r-f meter, which is illuminated edgewise, has blue scales on a black background. This can make it a bit difficult to interpret under most conditions. Although the 2½" (6.4-cm) oval speaker is bottom-facing, it puts out a hefty audio signal with an excellent response that makes for easy intelligibility and readability.

CIRCLE NO. 83 ON FREE INFORMATION CARD

## PROCESSOR TECHNOLOGY MODEL VDM-1 VIDEO DISPLAY MODULE

*Plugs into busline to provide 16 lines, 64 characters wide.*

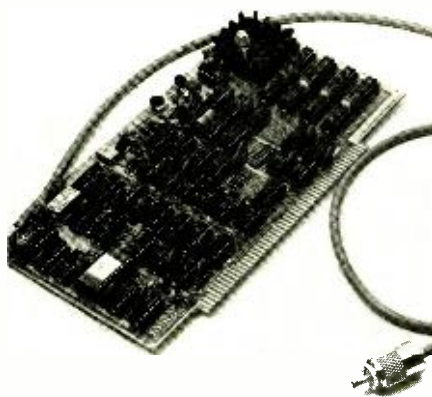

**T**HE TYPE of computer busline used in the Altair 8800 and Imsai 8080 has become one of the most popular elements in the area of hobby type minicomputers. A number of devices have been designed to plug directly into this bus, a very useful one being the Processor Technology Model VDM-1 video display module, which occupies a single slot in the computer.

The video display module generates a page of text consisting of 16 lines by 64 characters wide. It provides the full 128 upper- and lower-case and control ASCII character set in a 7 × 9 dot matrix format and has an on-board memory system consisting of 1024 8-bit bytes of RAM. The two-port memory permits random read/write access to the screen from the CPU.

The VDM offers a choice of white-on-black or black-on-white switch-selectable for the entire screen or separately program controlled for each individual character; switch-selectable horizontal and vertical display position; switch-selectable text blanking for the CR control character to the end of the line or from the VT

character to the end of the screen; program control for scrolling in increments of one to 16 lines without rewriting memory; and "window-shade" blanking of the text above the desired starting location under program control.

The Model VDM-1 is available only in kit form through most computer stores for \$199.

**General Information.** The output of the video display module is a standard video signal. It couples directly to a video monitor or converted TV receiver via a coaxial cable that comes with the kit. (The assembly manual provides an extract from the Howard W. Sams book *TVT Cookbook* by Don Lancaster to illustrate some methods of converting TV receivers into video monitors.)

The assembled VDM can be installed and tested in an operating and running Altair-8800 or Imsai-8080 minicomputer without a language. All you need to get the system running is the computer and a video monitor. The manual illustrates some simple programs that can be fed into the

computer with front-panel switches to completely test the video display module and provide some familiarity with using it.

Processor Technology provides two types of software. The first is a machine language VDM driver that requires 512 bytes located anywhere but at the beginning of the computer's memory. (The company recommends the use of the last 512 bytes of the memory block.) All documentation is provided for this program. If you have BASIC, you use the BASIC-VDM driver tape. In this case, you also use the last 512 bytes of memory and run the tape. In essence, the BASIC program peeks and pokes around the language, determining the status and I/O values and patch points and loading the software into memory.

Once the driver software is loaded into the computer, everything thereafter is automatic. Following a brief pause, the system is coupled to the VDM. You then have a choice of output to either the VDM or the original input port for hard copy. To make your choice, you simply set switch A8 on the computer up or down.

One very interesting command that the VDM provides is "speed control." Simply by pressing any numeral key on the keyboard, you can control the speed of the program. Hitting the 1 key introduces no delay, and the characters on the screen whiz by at a rate of 2000 64-character lines/minute. As you proceed upward in numbers, the speed slows down until at 8, the characters move by at a rate of about 1.5/second. To stop the display at any time, you press the space bar. The space bar also lets you single-step through the program.

**User Comment.** The VDM is entirely assembled on a single, very large printed circuit board that has conductors on both sides and plated-through

holes. The top of the board is silk-screened to show component locations. Mounted on the board are 49 IC's, including the voltage regulator, plus a number of resistors and capacitors, two miniature potentiometers, a crystal, a couple of transistors and diodes, and a miniature DIP switch. The finished board, needless to say, is rather crowded.

Assembly itself is quite straightforward if you use a low-wattage soldering pencil or iron and fine wire solder. The manual is so well written and well illustrated that the VDM can be assembled and put into service in a single evening. The kit is complete, right down to the solder. The only things you need to put it together are a soldering iron, longnose pliers, and wire cutters.

The basic kit comes without IC sockets. However, Processor Technology offers an optional IC socket package that we decided to use with our VDM and highly recommend to anyone else who plans to build the video display module.

The board is wired according to a set sequence, as described in the manual. Initially, all parts except the IC's are mounted and soldered into place. Then, the IC's are installed in groups in a specific order. After the first group is installed, a test is performed. If the results of the test are correct as described in the manual, you go on to install the next set of IC's and perform the test for them, and so on until all IC's have been installed and tested. In this manner, if any problems develop, you can quickly pinpoint where they exist. If all IC's were installed before any tests were made and a problem cropped up, troubleshooting the VDM would be a frustrating, time-consuming procedure.

We have been using the Model VDM-1 for a couple of months and have had flawless operation from it during the whole time. Having used 32-character-wide terminals in the past, we always had to rewrite programs originally written for TTY to get them to run in our computer. Now that we have a 64-character-wide VDM, we do not have to go through the painstaking rewriting of programs.

If you have a compatible operating computer system or are planning to buy one, we highly recommend a Model VDM-1 to use with it. For the performance it provides, the VDM-1 is very inexpensively priced.

CIRCLE NO. 84 ON FREE INFORMATION CARD

OCTOBER 1976

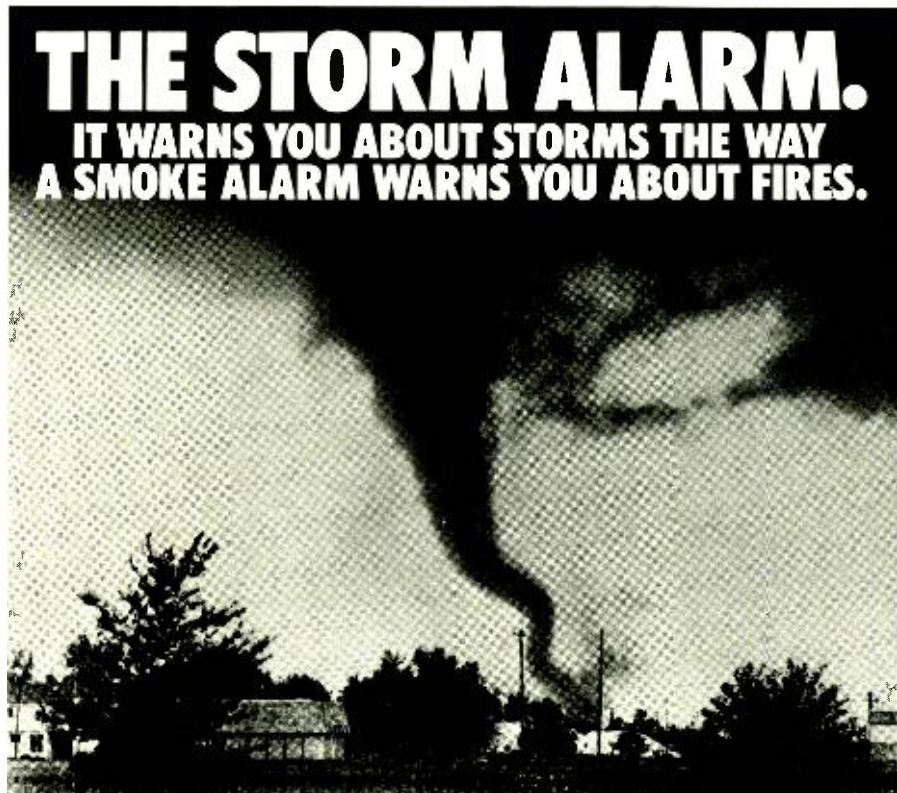

# THE STORM ALARM.

IT WARNS YOU ABOUT STORMS THE WAY  
A SMOKE ALARM WARNS YOU ABOUT FIRES.

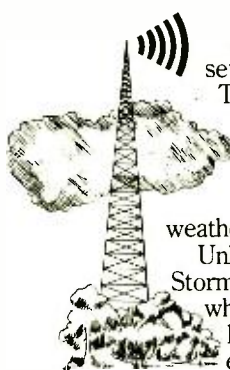

It sounds an alarm.

A built-in alarm that's set off any time—night or day—when severe weather threatens.

The alarm is triggered by a signal from your local National Weather Service transmitter.

After it sounds, a complete report on the danger and survival instructions come on.

When conditions are normal, the Storm Alarm picks up the weather station's continuous, up-to-the-minute forecasts.

Unlike ordinary weather radios, which the user must monitor, the Storm Alarm continually monitors itself. The alarm sounds full blast whether or not you have the volume turned up and are listening. You're warned even when sleeping.

The unit was developed in support of the National Weather Service's new reporting system. Now, more than ever, tornadoes, hurricanes, severe thunderstorms and marine emergencies present a constant threat to life and property.

Crystal-controlled and switch-selectable. Superior reception from as far out as 40-50 miles.

Works on AC. Built-in back-up battery feature. 25" telescoping antenna. 2 1/4" speaker. Unit only 3" x 5" x 1 1/4".

No wonder a leading electronics magazine called it a "sensitive weather receiver, and for a relatively low price (under \$40) an excellent disaster alarm."

For a free "Tornado Tips" booklet and the name of your nearest dealer, write us at 637 S. Dearborn, Chicago, Ill. 60605.

Get the Storm Alarm. It's a foul and fair weather friend.



## STORM ALARM

FROM WEATHERALERT

© 1976 by Weatheralert™, Chicago, Ill. 60605

CIRCLE NO. 78 ON FREE INFORMATION CARD

www.americanradiohistory.com



# CB Scene

By Ray Newhall, KW1G010

## THE LONG AND THE SHORT OF ANTENNAS

**A**N INEFFICIENT CB antenna system can easily waste more than half of the total power your transmitter pumps into it. Such losses could reduce your range by 50% and eliminate much of the punch you should get from your CB rig. To help you understand why, here are the most important antenna concepts described in plain language that doesn't require an engineering degree to understand. You should be able to use this information to improve your own antenna systems.

The maximum legal output power at a CB transceiver's antenna jack is four watts. Most modern transmitters actually produce an acceptable 3.5 to 3.9 watts when properly installed. It should be evident that all possible steps must be taken to minimize transmission line and antenna losses so that most of that power is transformed into the electro-magnetic radiation we call radio.

The antenna must be "tuned" to resonate at the proper frequency and the transmission line must be "matched" to the input impedance of the antenna. Otherwise, some of the power will be reflected back along the transmission line towards the transmitter and be dissipated as heat. In fact, if enough of the power is reflected, the transmitter may actually be damaged.

**Standing Wave Ratio.** The most common measure of antenna efficiency is expressed as a ratio of the power supplied to the antenna divided by the power reflected back to the transmitter. This measurement is called the Standing Wave Ratio (SWR). The Standing Wave Ratio of the perfect antenna system would be 1:1, but no antenna is perfect and any SWR of 2:1 or less is excellent. A ratio of 3:1 or less is acceptable. If the ratio is 10:1 or more, there is probably a short or an open circuit somewhere in the system, the antenna needs tuning or you are

not using the proper type of transmission line. Radio-frequency power is difficult to measure accurately and those meters that can separate the forward and reflected power and then measure them accurately are prohibitively expensive. But we get a fairly accurate *relative* indication of SWR by measuring either the voltage or the current at a particular point in the transmission line, and displaying the peak value on a low-cost dc microammeter. A reflectometer or SWR bridge is a low-cost meter which allows you to make such measurements readily. It should always be used when the antenna is installed, and again at intervals of six months or so. This will insure that your antenna continues to operate at top efficiency. The SWR bridge should be accepted for what it is, but many people place absolute faith in its readings. Most of these devices measure only the relative voltage peaks at the point in the line where they are inserted. When an r-f transmission line is mismatched and an SWR exists, the voltage and current in the line vary with line length. Accordingly, the SWR bridge can give different readings at different points along the line.

So when your CB buddy tells you that you can improve your SWR by installing a 12-foot transmission line, he is actually telling you how to improve your meter reading. But the actual SWR cannot be affected by changing the length of the coax. However, due to an entirely different effect, a transceiver will work better with some line lengths than with others if there is a high SWR on the line! In any event, both these conditions are symptoms of a mismatch.

To use the SWR bridge, its terminal marked "transmitter" should be connected to the transmitter's antenna terminal through a short piece of coax with the proper coax connectors on both ends. The "antenna" terminal on the bridge is connected to the trans-

mission line. With the "forward-reverse" switch in the FORWARD position, key the transmitter and adjust the SENSITIVITY control so the meter needle is at the full-scale position. Now switch the bridge to the REVERSE position and key the transmitter again. Most SWR bridges are calibrated to read SWR directly, but no matter—you should tune your antenna for the lowest possible REVERSE reading. The reading you get is only relative and probably does not represent an accurate SWR.

However, if the reading is much above 2:1, turn off the transmitter immediately before it is damaged. Disconnect the transmission line at both ends and use an ohmmeter to check it for continuity and for no shorts between the braid and inner conductor. If the line is OK, the problem is most likely in antenna tuning. Check the antenna and be certain it is properly installed. (Unless you really know what you are doing, you should always buy a commercial antenna.)

Take SWR readings at several different frequencies across the band. Determine, if possible, at which frequency it appears the lowest. If the SWR is at its lowest at one of the low channels (1 or 2), the antenna is too long and should be shortened. (Most mobile antennas have provision for adjusting the length somewhat.) If the lowest SWR appears at the highest channel number, the antenna is too short. The antenna should be tuned until the lowest SWR appears close to channel 13, the center of the Class D band.

If you have checked all connections and tuned the antenna carefully yet still cannot get the SWR less than 3:1, it is probable that you have failed to establish an effective ground plane for the antenna. Ground planes are discussed later on in this column.

**Coax.** Another problem sometimes encountered is in the transmission line you are using. The standard transmission line for CB radio is RG-58/U or RG-8/U (50 ohms impedance). Be careful not to use 75-ohm TV coaxial cable (RG-59/U) because it will not match accurately to the antenna. (There are exceptions to this rule; but in such a case, the manufacturer will provide the proper cable cut to the exact length required). If the transmission line can be less than 30 feet in length, then the smaller RG-58/U cable is probably adequate. But if the cable



must be longer than 30 feet, the larger RG-8/U (or equivalent) should be used to prevent excessive power losses.

The transmission line should be as free as possible from splices, and care should be taken to avoid bruises and protect it from moisture. All splices and connectors should utilize uhf coaxial fittings of the PL-259/SO-239 type. The Amphenol Division of Bunker Ramo has recently announced a new solderless model of the PL-259 for RG-58/U, which they have named 83-58FCP. It gives a physically strong, electrically superior connection, in a fraction of the time required to assemble a soldered connector. It is about the same retail price as the commonly-used PL-259 (see photo). Only a pocket knife and a pair of pliers are required.

**Ground Plane.** By the time you have installed the proper type of CB antenna and tuned it as described above, you should have achieved an SWR of 2:1, or less. If not, the chances are that it doesn't have an adequate ground plane.

To understand the concept of the ground plane antenna, we'll have to discuss a little more antenna theory. The basic dimension for an antenna is one half of a wavelength, and wavelength is tied directly to the operating frequency. For the Class D Citizen's Band, the wave length is about 11 meters (36 feet). A half-wave vertical antenna extends 18 feet into the air, and is normally fed at the center point to form a "half-wave dipole."

But for most applications, an 18-foot antenna is unwieldy, especially for mobile applications. Fortunately, when mounted on a "ground plane," the antenna need only be half as long, with the missing quarter wavelength appearing as the *reflected electrical image* in the ground plane. At 27 MHz, a quarter-wave ground plane antenna has an electrical length of about 108 inches, but it may be shortened physically by incorporating a "loading coil" into its length. A ground plane antenna will also resonate at five-eighths of a wavelength and provide some power gain. Although 22 feet is usually too long to be practical for a mobile, it is used for some base stations.

The most effective ground plane is a flat conductive surface perpendicular to the axis of the antenna at its base, but isolated from it by a high impedance to r-f current. When the antenna

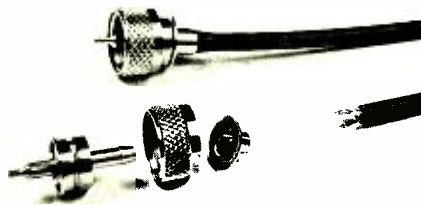

*Amphenol FCP connector with RG-58U coax cable.*

is fed by coaxial cable, the center conductor is connected to the antenna and the braid is connected to the ground plane. The ground plane should extend for at least a quarter wave-length in all directions from the antenna. In practice, a ground plane may be formed by three or four radial elements extending from the base of the antenna, or by the metal body of a vehicle. The radials used on base station antennas are often allowed to droop somewhat to provide a better impedance match to 50-ohm cable.

When the body of an automobile forms the ground plane, it is generally not large enough to extend nine feet in all directions, so the ground plane is not symmetrical. Under these circumstances, the radiation pattern of the antenna may be warped somewhat. The strongest signal will be radiated in the direction of the largest portion of the ground plane, and the signal will be diminished in the direction of the smallest portion. However, the total radiated power will remain constant except in extreme cases where the antenna is detuned and will not load properly. In short, the size and shape of the ground plane will have a major effect upon the symmetry of the horizontal radiation pattern.

The ground plane antenna is by far the most popular for use on CB because its dimensions make it useful for both base and mobile applications. However, on wood or fiberglass boats and campers it may not be possible to use a ground plane. For these applications, there are vertical half-wave dipole antennas available. These too may be physically shortened by use of loading coils. Such antennas are referred to as "marine" or "coaxial" antennas, and they cannot be used interchangeably with ground plane antennas.

All antennas discussed thus far have been of the "omni-directional" type. They can be used on CB without height restriction, except that they may not extend more than 60 feet

above the ground, natural formation, or man-made structure. Beam antennas can also be used on CB, but the height restrictions are more stringent. Any antenna which features distinct directional qualities may not be mounted more than 20 feet above ground, etc. Beam antennas are complex and may assume many forms including Yagis, Quads and phased arrays. The principles discussed above apply to all antennas. If you follow them carefully, you should be able to install an efficient antenna system, and keep it working efficiently. ♦



Hot soldering irons can be murder on delicate electronic components such as IC's. That's why the DIGI-DESIGNER will become your bugs' best friend. It's a solderless breadboarding instrument that can save you time and burned out parts.

DIGI-DESIGNER comes complete with clock, dual pulsers, logic monitors, voltage switches, built-in 5 volt supply, binding posts for external power, input/output BNC's, and more. Everything you'll need for fast, efficient circuit design.

Use the coupon below to order your kit today. U.S. price - \$70.00



### CIRCUIT DESIGN, INC.

Division of E & L Instruments, P.O. Box 24,  
Shelton, Conn 06484

Please send your model DD-1K DIGI-DESIGNER in kit form (price \$70.00).

Name \_\_\_\_\_

Address \_\_\_\_\_

City \_\_\_\_\_ State \_\_\_\_\_

Zip \_\_\_\_\_ Telephone \_\_\_\_\_

Enclose check, money order or numbers from BankAmericard or Master Charge. We will ship post paid anywhere in continental U.S.



# Computer Bits

By Hal Chamberlain

## COMPUTER MUSIC—PART II

**L**AST MONTH we discussed computer music techniques in general and simple timed-loop techniques specifically. Some short, illustrative programs for an 8080-based microcomputer were given. Also a circuit for a simple 8-bit digital-to-analog converter was shown. Now, we will delve a little deeper into computer music techniques that have the potential for producing complex, serious musical results.

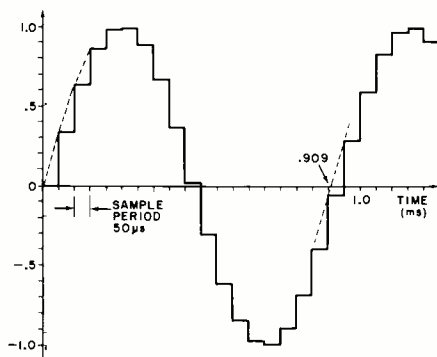

Fig. 1. Sampled sine wave.

**The Sampling Theorem.** Any waveform, no matter how simple or complex, can be represented as a series of discrete voltage values such as might come from a digital-to-analog converter (DAC). Figure 1 shows a sine wave as it might appear at the DAC output. This is termed a "sampled representation" because the sine-wave voltage is sampled at discrete points in time and held until the following sample point. Obviously this is a very poor sine wave, a fact that is easily demonstrated with a distortion analyzer.

Before giving up, let us look at the

frequency spectrum of this staircase-like wave on a spectrum analyzer. To be specific, the sine-wave frequency is approximately 1.1 kHz, corresponding to 0.909 milliseconds per cycle. The sampling frequency, often called sampling rate, is 20 kHz or one sample every 50 microseconds. The spectral plot shows a strong frequency component at 1.1 kHz, which is the desired sine wave we are trying to synthesize. Also shown are the distortion product frequencies caused by the sampling process. Since all of the distortion components are much higher in frequency than the desired signal, they may be attenuated or removed with a sharp low-pass filter. After filtering, the distortion analyzer will confirm that a smooth, pure, sine wave is all that remains.

What will happen if the sine-wave frequency is increased but the sampling frequency remains the same? With fewer samples on each sine-wave cycle, the waveform from the DAC will appear to be even more distorted. Close examination of the first pair of distortion components in Fig. 2 will reveal that they are very much like sidebands of a 20-kHz suppressed carrier "modulated" by a 1.1-kHz "signal." The lower sideband frequency is the carrier (20 kHz) minus the signal (1.1 kHz) or 18.9 kHz. The upper sideband frequency is the sum, or 21.1 kHz. There are also sideband pairs at harmonics of the sampling frequency. If the sine-wave frequency is increased, the lowest distortion component will move downward toward it, leaving less room for the low-pass filter to do its work. The limit oc-

curs when the desired frequency and the lowest distortion frequency actually meet each other at 10 kHz and can no longer be separated with the filter. The rule is that the highest frequency that can be reproduced with a sampled waveform is one-half of the sampling frequency. Actually achieving this requires an infinitely sharp filter; a more practical figure is  $\frac{1}{4}$  or  $\frac{1}{3}$ .

Of course a real digital-to-analog converter cannot generate voltages that are exact samples of the sine wave. An 8-bit converter, for example, has only 256 possible output voltage values. When a particular voltage is needed, the nearest available value will have to be used. This "round-off" error gives rise to another type of distortion in sampled waveforms called *quantization noise* which is spread throughout the frequency spectrum. The theoretical signal-to-quantization noise ratio is easily computed as  $6N + 4$  dB, where  $N$  is the number of bits in the DAC. Actually this assumes an ideal DAC; a realistic figure is about 5 dB less. Still, an 8-bit DAC yields nearly 50 dB, as good as many tape recorders. With a 12-bit DAC, the quantization noise is negligible.

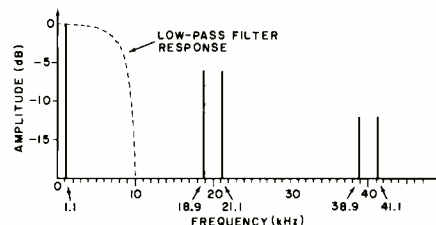

Fig. 2. Spectrum of Fig. 1.

**Waveforms From Tables.** With this background, it is apparent that a sampled representation of a waveform may be stored in the memory of a computer. A simple way to do this is to store one cycle of the waveform in a small block of memory as a "table." Now the waveform can be reproduced by having a program scan through the table in memory and send the samples to a DAC. The frequency of the waveform is a function of the sample rate (time between sending out successive samples) and the number of points tabu-

FIG. 3

```
*
* TOUCH-TONE TRANSMIT SUBROUTINE
* ENTER WITH DIGIT TO SEND IN A, 4 BIT BINARY CODED DECIMAL
* EXITS WITH ALL REGISTERS DESTROYED
* ASSUMES 2 MHZ CLOCK AND NO MEMORY WAITS
* SENDS TONES FOR 200 MILLISECONDS, SILENCE FOR 100 MS
```

```
000:200
000:200 346 017
```

```
ORG 200Q
TTXMIT ANI 017Q MASK OFF EXCESS BITS IN A
```

(Subroutine continued on page 91)

# Stop Throwing Your Money Away!!

## Don't Discard...Recharge With These

### NICKEL CADMIUM

### BATTERIES AND CHARGER

### 500 to 1000 Times!!

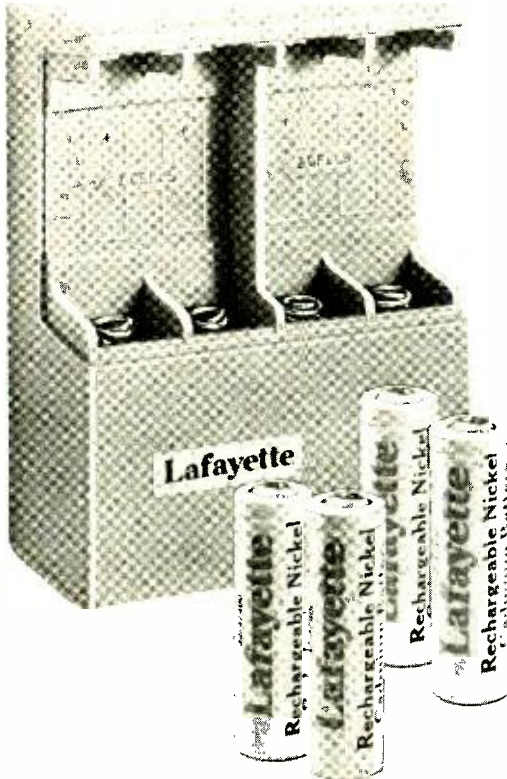

These dependable, long-life, AA 1.25 volt penlite batteries really standup to the toughest use with a 500 milliamp hour capacity—they last for years. When they do run down, automatically recharge them in the easy to use, safe, Lafayette Battery Charger, instead of throwing them away. Hermetically sealed, these nickel cadmium cells are long-lasting, high energy batteries that won't deteriorate when not in use the way ordinary cells do.

They're ideal for radios, walkie-talkies, citizens band, flashlights, calculators, cassette recorders, photo flash units, hobby models, shavers, toys, power tools, portables—everywhere you use AA penlite size cells. \$500,000,000 is thrown away each year on ordinary batteries, wasting money and resources. Rechargeable batteries give value-conscious users what you're looking for—more for your money. These batteries offer the greatest economy, lower operating cost-per-hour than throwaways, including "long-life" or alkaline batteries, and there's no "fading power", just continuous output and constant voltage. The more you use them, the faster they pay for themselves. Get the Lafayette Battery Charger for \$8.95 and four AA penlite battery cells for \$7.80, plus shipping and sales tax. Extra sets of four batteries also available at \$7.80 each plus shipping.

The batteries and charger are backed by Lafayette's 56 years of electronic leadership and a 30-day money back policy of your satisfaction. Order yours today and stop throwing your money away.

# Lafayette

Radio Electronics & Shopping Centers

**LAFAYETTE RADIO ELECTRONICS CORP.**  
 DEPT. 600  
 111 JERICHO TURNPIKE, SYOSSET, L.I., N.Y. 11791

NAME \_\_\_\_\_

STREET \_\_\_\_\_

CITY \_\_\_\_\_

STATE \_\_\_\_\_ ZIP CODE \_\_\_\_\_

Charge my  MASTERCHARGE or  BANK AMERICARD (check)

MASTERCHARGE Interbank #     (to left of expiration date)

Expiration date \_\_\_\_\_

Please send me the items checked below and a FREE 164 page electronics catalog. Enclosed please find payment, including sales tax, where applicable. If not delighted, I may return the batteries and charger undamaged within 30 days for a full refund.

Item	Indicate Qty.	Stock #	Cost	Total	
Charger and 4AA Penlite Batteries		32-Z-99062M	\$16.75 + 1.00 shipping (\$17.75)		
Sets of 4 additional AA penlite batteries		32-Z-99054M	\$7.80 + 30¢ shipping (\$8.10)		
FREE 1977 Lafayette Catalog	1	10-Z-98003	Free	—	—
			Add sales tax where applicable.		
			Total \$ Enclosed		

Use Bank Americard or Master Charge on mail or phone orders if you wish. Call (516) 921-7500 9:00 AM to 5:00 PM

# FREE EICO CATALOG

## 358 Ways To Save On Instruments, Citizens Band, Burglar Alarms, Automotive & Hobby Electronics!

The more you know about electronics, the more you'll appreciate EICO. We have a wide range of products for you to choose from, each designed to provide you with the most pleasure and quality performance for your money. The fact that more than 3 million EICO products are in use attests to their quality and performance.

**"Build-it-Yourself" and save up to 50% with our famous electronic kits.**

For latest EICO Catalog and name of nearest EICO Distributor, check reader service card or send 50¢ for fast first class mail service.

**EICO—283 Malta Street,  
Brooklyn, N.Y. 11207**

*Leadership in creative electronics  
since 1945.*



lated for one cycle. If the sample rate is varied, care must be taken to prevent it from becoming too low.

A better way is to alter the apparent table length by scanning every second, third, etc. entry during the output process. This restricts us to a few specific frequencies. Any frequency may be generated by allowing "fractional" scan increments. When fetching a table entry, the nearest one would be used but the fractional part would be retained when computing the location of the next table entry. A prime advantage of waveform tables is that the tone color can be changed simply by using a different table.

**Mixing Computed Waveforms.** If a computer is to play interesting music with chords, counterpoint, etc., then two or more simultaneous tones will be required. One approach is to use multiple DAC's and an audio mixer along with a program to constantly feed sample values to each DAC from tables in memory. The same effect can be achieved with one DAC if at each sample time the current sample values for all tones are added together and the sum sent to the DAC. Of course the sample rates of all of the tones must be the same. Even relative loudness can be controlled by multiplying a tone's sample value by a "loudness factor" before it is added to the total. Attack and decay envelopes can be simulated by constantly changing the loudness factor. Care must be taken to avoid arithmetic overflows, however. Typically, the intermediate arithmetic is done to 16 or more bits of accuracy and the final result is rounded off to the number of bits used by the DAC.

**Touch-Tone Program.** Many of the concepts just discussed are illustrated by the Touch-Tone<sup>®</sup> transmit subroutine in fig. 3. A Touch-Tone digit consists of two simultaneous sine-wave tones, one from a low-frequency group (697, 770, 852, 941 Hz) and one from a high-frequency group (1209, 1336, 1477, 1633 Hz). The routine actually synthesizes the two tones already mixed together through an output port equipped with the simple DAC mentioned earlier.

The routine is called with register A containing the digit to be transmitted in binary. Using the binary code, the routine accesses a frequency table to determine what the "table increment" value for each tone should be. For example if a "4" is to be sent, every

tenth sine-table entry would be used for the 770-Hz tone and every fifteenth for the 1209-Hz tone. Note that this gives only approximate frequencies; the 1209-Hz tone is off 3%, but the others are off less than 1.5%.

For the actual tone-generation task, the routine maintains two sine-table pointers, one for each tone. To compute a mixed-tone sample, the sine-table entry pointed to by each pointer is fetched, they are added together, and the sum is divided by 2 to produce an 8-bit result. For the next sample, the corresponding increment is added to each pointer. Overflow of the lower pointer byte is ignored to provide for "wrap-around" to the beginning of the sine table when a cycle is completed. The loop for computing samples is 100 machine cycles long, which gives a 20-kHz sample rate assuming a full-speed 8080 system. With this fairly high sample rate, low-pass filtering can be accomplished with tone controls or a scratch filter.

The routine can be expanded for more simultaneous tones if desired or a different waveform can be entered into the table. There is a definite limit to the computation between samples, otherwise the sample rate may fall too low to be useful. Also, the loop times have to be carefully controlled.

**Mass Storage And Playback.** In music programs for large computers, the computed waveform samples are not sent directly to a digital-to-analog converter. Instead they are saved on a mass-storage device and "played back" later. The advantage of this approach is that time is not a factor when the samples are computed. The calculations may be as complex as necessary or a high-level language can be used with no effect on the sample rate during playback. This method has perfect generality; any possible sound or combination of sounds can be synthesized, subject only to frequency-response limitations imposed by the playback sample rate.

The problem for hobbyists of course is standing the expense of a suitable high-speed, large-capacity mass-storage device. Interesting experiments can be performed however with systems having 16k or more of memory. At a 10-kHz sample rate, which gives AM radio quality, a 24k machine can hold over 2 seconds of sound. For the industrious, two-second segments can be recorded on audio tape and spliced together for the final result. ♦

```

000:202 041 271 000      LXI H,TTTABL      GET ADDRESS OF FREQUENCY TABLE
000:205 207              ADD A              DOUBLE CONTENTS OF A
000:206 205              ADD L              ADD RESULT TO TABLE ADDRESS
000:207 157              MOV L,A            MOVE FIRST TABLE ENTRY
000:210 176              MOV A,M            TO TONE A INCREMENT
000:211 062 331 000      STA TONAIN
000:214 043              INX H              MOVE SECOND TABLE ENTRY
000:215 176              MOV A,M            TO TONE B INCREMENT
000:216 062 332 000      STA TONBIN
000:221 001 240 017      LXI B,7640Q       SET COUNT FOR 200 MILLISECONDS IN BC
000:224 021 000 001      LXI D,SINET        SET DE TO POINT TO SINE TABLE
000:227 041 000 001      LXI H,SINET        SET HL TO POINT TO SINE TABLE
000:232 032              TONES LDAX D         GET TONE A SAMPLE FROM SINE TABLE
000:233 206              ADD M              ADD TO IT TONE B SAMPLE
000:234 037              RAR                DIVIDE SUM BY 2
000:235 323 XXX          OUT (port address) SEND TO OUTPUT PORT WITH 8 BIT DAC
000:237 072 331 000      LDA TONAIN         GET TONE A INCREMENT
000:242 203              ADD E              ADD TO IT TONE A SINE TABLE POINTER
000:243 137              MOV E,A            UPDATE TONE A POINTER
000:244 072 332 000      LDA TONBIN         GET TONE B INCREMENT
000:247 205              ADD L              ADD TO IT TONE B SINE TABLE POINTER
000:250 157              MOV L,A            UPDATE TONE B POINTER
000:251 013              DCX B              DECREMENT AND CHECK TONE DURATION COUNT
000:252 170              MOV A,B
000:253 261              ORA C
000:254 302 232 000      JNZ TONES          LOOP FOR ADDITIONAL SAMPLES UNTIL DONE
000:257 001 100 037      LXI B,17500Q       SET COUNT FOR 100 MILLISECONDS OF SILENCE
000:262 013              SILENC DCX B        DECREMENT AND CHECK SILENCE DURATION COUNT
000:263 170              MOV A,B
000:264 261              ORA C
000:265 302 262 000      JNZ SILENC         LOOP UNTIL COUNT RUNS OUT
000:270 311              RET                RETURN

```

\* TOUCH-TONE FREQUENCY TABLE, TWO VALUES PER ENTRY

```

000:271 014 021      TTTABL DEF 12,17      0 941 1336
000:273 011 017      DEF 9,15              1 697 1209
000:275 011 021      DEF 9,17              2 697 1336
000:277 011 023      DEF 9,19              3 697 1477
000:301 012 017      DEF 10,15             4 770 1209
000:303 012 021      DEF 10,17             5 770 1336
000:305 012 023      DEF 10,19             6 770 1477
000:307 013 017      DEF 11,15             7 852 1209
000:311 013 021      DEF 11,17             8 852 1336
000:313 013 023      DEF 11,19             9 852 1477
000:315 011 025      DEF 9,21              A 697 1633
000:317 012 025      DEF 10,21             B 770 1633
000:321 013 025      DEF 11,21             C 852 1633
000:323 014 025      DEF 12,21             D 941 1633
000:325 014 017      DEF 12,15             * 941 1209
000:327 014 023      DEF 12,19             # 941 1477

```

```

000:331              TONAIN DST 1          STORAGE FOR TONE A INCREMENT
000:332              TONBIN DST 1          STORAGE FOR TONE B INCREMENT

```

- \* SINE TABLE FOR USE WITH TOUCH TONE SUBROUTINE
- \* MUST BE AT A PAGE BOUNDARY
- \* LISTED IN MEMORY DUMP FORMAT TO CONSERVE SPACE

```

001:000 200 203 206 211 214 217 222 226 231 234 237 242 245 250 253 256
001:020 261 263 266 271 274 277 301 304 307 311 314 316 321 323 326 330
001:040 332 334 336 341 343 345 346 350 352 354 355 357 361 362 363 365
001:060 366 367 370 371 372 373 374 375 375 376 376 377 377 377 377 377
001:100 377 377 377 377 377 377 376 376 375 375 374 373 372 371 370 367
001:120 366 365 363 362 361 357 355 354 352 350 346 345 343 341 336 334
001:140 332 330 326 323 321 316 314 311 307 304 301 277 274 271 266 263
001:160 261 256 253 250 245 242 237 234 231 226 222 217 214 211 206 203
001:200 200 175 172 167 164 161 156 152 147 144 141 136 133 130 125 122
001:220 117 115 112 107 104 101 077 074 071 067 064 062 057 055 052 050
001:240 046 044 042 037 035 033 032 030 026 024 023 021 017 016 015 013
001:260 012 011 010 007 006 005 004 003 003 002 002 001 001 001 001 001
001:300 001 001 001 001 001 001 002 002 003 003 004 005 006 007 010 011
001:320 012 013 015 016 017 021 023 024 026 030 032 033 035 037 042 044
001:340 046 050 052 055 057 062 064 067 071 074 077 101 104 107 112 115
001:360 117 122 125 130 133 136 141 144 147 152 156 161 164 167 172 175

```



# Amateur Radio

By Herbert S. Brier

## 250 WATTS FOR NOVICES

**E**FFECTIVE July 23, 1976, the FCC raised the permissible dc power input limit for Novices from 75 to 250 watts. The Commission also set the same power limit for all other amateurs using Novice frequencies. In the same notice, Technicians received Novice hf privileges. Also, the Technician and Conditional Class licenses issued by mail became equivalent in all respects to Technician and General Class licenses, respectively, earned before an FCC examiner.

Since that date, the only amateur license issued by mail is the Novice Class, with one exception. If an applicant is disabled, and that disability is confirmed by a doctor's certificate, examinations can be conducted in the home under the supervision of a volunteer examiner selected by the Commission.

Two other changes affect Novices. The one-year wait between the expiration date of a previous amateur license and a Novice ticket has been eliminated. Now, by proper timing, a Novice whose license will expire can be retested before his current term runs out. In addition, the Novice exam contains material not covered in any other amateur examination. Therefore, all higher class tests will include the Novice exam. To prevent applicants who want Novices in a hurry from trying to get the ticket at an FCC office, the Novice questions will be graded only after the other elements have been passed.

**Equipment.** The eyes of many Novice and Technician operators probably gleam as they imagine how much stronger their signals will be with 250 watts of input power in place of 75 watts. But the change will not be as dramatic as they might hope. This increase is equivalent to 5.2 dB. If the fellow you're working has an S meter that moves one S unit for a 6-dB increase in signal strength, switching from the old power limit to the new one will boost your signal just under one S unit—a useful, but hardly spectacular, change. (However, very few of us have S meters that follow this "textbook" behavior!)

The most important benefit that Novices receive from this change is a wider selection of equipment suitable for Novice use. In the 75-watt category, the only transmitters that can be purchased *new* are the Heath DX-60B and the HW-16. The DX-60B has a maximum input power of 90 watts, covers 80 through 10 meters in the CW and AM (screen modulation) modes. The HW-16 transceiver covers the CW portions of the 80-, 40-, and 15-meter bands. Both are in kit form, and have given many amateurs valuable experience in building and operating them. But most amateurs who have "cut their teeth" using the rigs have sold them upon receipt of the General or Advanced Class

license, and applied the proceeds to the purchase of a CW/SSB transmitter or transceiver. So, although they were ideal "starter" rigs, these units were not long-term investments.

Under the amended rules, a Novice can now acquire one of the many transmitters or transceivers in the 180-to-250-watt class not only for use under his current license, but for General and higher class operation as well. These rigs work excellently on CW, most with partial or full break-in. Plugging a mike into them makes operation on SSB phone possible, and many will also work on RTTY and slow-scan TV with the addition of accessory equipment.

Standard amateur gear in transceiver or "separate" form covers 80 through 10 meters. A few also offer 160 meters. Transceivers use many stages which perform two different functions. (For example, a buffer amplifier during transmit can be an i-f amplifier on receive.) Their advantages are economy, compactness, and ease of operation. However, they can transmit and receive only on the same frequency, unless the transceiver has "receiver incremental tuning" or can accommodate an external vfo. Receiver incremental tuning allows the receive frequency to be shifted up or down a few kilohertz without affecting the transmit frequency. External vfo's allow you to transmit at one end of the band and receive at the other.

Most often, amateurs on the hf bands transmit and receive on the same frequency. But some DX stations won't listen on their own frequency, directing stations to call "10 kHz up" or so. Also, some DX SSB stations transmit in the "foreign phone" bands, such as 14.1 to 14.2 MHz. U.S. amateurs wishing to talk to them must transmit somewhere above 14.2 MHz and listen below that frequency. So, if you plan to chase a lot of DX, you should get either a separate transmitter and receiver or a transceiver that can accept a remote vfo.

"Separates" are more expensive than transceivers, require more room, and are more versatile. Because they can be individually adjusted for optimum performance, separates operate somewhat more efficiently, especially on receive. Exact comparisons on a cost-vs-performance basis are difficult, however. A compromise between transceivers and separates are "matched" transmitters and receivers. They can be operated in the transceive or independent mode at the flick of a switch.

Oddly enough, most matched transmitters have lower power output levels than transceivers—150 to 200 watts compared to up to 500 watts PEP, respectively. The first SSB transceivers were designed for mobile operation, and TV sweep tubes were put in them to get high peak power in a small package. Such tubes work well, but their distortion

products are somewhat higher than those from tubes specifically designed for hf SSB transmitting. As a result, most separates and some transceivers accept one to three dB less output power in return for measurably lower distortion, and use 6146B tubes. But even those rigs with 180 watts of input power (about 100 watts out) can drive 2000-watt, grounded-grid linears. So don't let their "low" power levels fool you. They can be operated barefoot for most contacts, and be switched over to drive a linear if conditions get really bad.

High-power r-f transistors are still very rare, and those solid-state transceivers currently on the market are limited to about 200 watts of input power. Most transmitters are either hybrid (solid-state oscillators, etc. with tube drivers and finals) or all-tube designs. Many transceivers are hybrids. However, many new receivers use no vacuum tubes, and this is the trend of the future for *all* amateur gear.

More important than the number of tubes or transistors that a piece of equipment has are its key specifications. For example, a receiver should have a sensitivity of less than 1  $\mu$ V at 10 dB S+N/N, an SSB selectivity of 2.1 to 2.5 kHz, and a CW selectivity of less than 500 Hz at the 6-dB points. A transceiver or transmitter should have 150 to 400 watts of input power on CW. A transceiver should be able to operate from 12 volts dc or 117 volts ac.

You should also consider how flexible a rig is before you buy it. For example, if you want to work vhf, does that receiver accept plug-in converters? Or, will that transceiver interface easily with a transverter, speech processor, or monitor scope? Get as much information as possible about each rig you are considering before making any decisions. The following manufacturers will supply specific information about their equipment upon request:

**Atlas Radio, Inc.,**

317 Via del Monte  
Oceanside, CA 92054

**Collins Radio Group,**

Amateur Radio Marketing,  
Rockwell International  
Cedar Rapids, IA 52406

**R.L. Drake Co.,**

Miamisburg, OH 45342

**Heath-Schlumberger,**

Benton Harbor, MI 49022

**Trio-Kenwood Communications, Inc.**

116 East Alondra,  
Gardena, CA 70248

**Swan Electronics,**

Div. of Cubic Corp.,  
305 Airport Road,  
Oceanside, CA 93054

**Tempo**

c/o Henry Radio Co.,  
11240 Olympic Blvd.,  
Los Angeles, CA 90064

**Ten-Tec, Inc.,**

Sevierville, TN 37862

**Yaesu Musen USA, Inc.,**

7625 E. Rosecrans, No. 29,  
Paramount, CA 90723.

I hope that I have not omitted any company currently manufacturing CW/SSB equipment for the hf amateur bands.

OCTOBER 1976

# BREAKER BREAKER

## ... for a 10-5 from the BLACK CAT®

Whether you're rolling in a convoy or copying the mail from your home twenty, you get a four roger every time with Black Cat® CB accessories from Wawasee Electronics. So if you've got your ears up copy the following list of rugged accessories:

- Antenna Whip
- JB 700 Mobile Antennas
- Trunk Lid Antenna Mount
- West Coast Antenna Mount
- 3-Ft. Jumper Cable
- 20-Ft. Jumper Cable
- Co-Phase Harness
- JB 1000 Dummy Load
- JB 1000 SM Oscilloscope / RF Wattmeter / SWR Bridge
- JB 2000 SW Power Meter / SWR Bridge



For a complete listing of all Black Cat® CB accessories and dealers, drop us a line and we'll get right back to you.

# WAWASEE ELECTRONICS

"HOME OF BLACK CAT® PRODUCTS"

Wawasee Electronics Co., Inc.

P.O. Box 36 • Syracuse, Indiana 46567

Phone: (219) 457-3191

CIRCLE NO. 77 ON FREE INFORMATION CARD

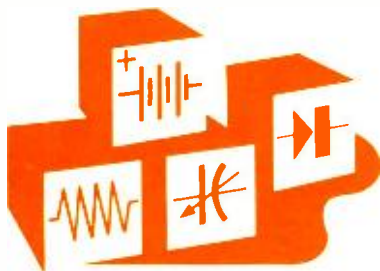

# Inside Basic Electronics

By Sol D. Prensky

## CAPACITORS AND RC CIRCUITS

**C**APACITORS are so important in the realm of electronics that you'd be hard pressed to find a circuit that doesn't employ at least one of them. Often, the capacitor is teamed with a resistor. This *RC* combination plays a dominant role in shaping the network's overall *frequency response*. For a clear understanding of *RC* circuits, we'll first take a close look at the capacitor, and then see how it behaves when paired with a resistor.

### Fundamentals of Capacitors.

Every capacitor consists of two conductive plates separated by an insulating medium called a *dielectric* (Fig. 1). When a dc voltage is applied across the capacitor (by closing the switch), electrons start flowing from the negative terminal of the battery onto the bottom plate of the capacitor. Simultaneously, the battery's positive terminal attracts electrons from the top plate. At first, the electrons flow fairly easily. But as more and more of them are piled up on the bottom plate, it becomes increasingly harder for any more electrons to join them.

Here's why. Electrons are all negatively charged, and like charges tend to repel each other. Eventually this repulsive force will counteract the force generated by the battery which causes electrons to move, and no more current will flow. (When we talk of "current," we refer to *conventional* current, which flows in the opposite direction to the motion of electrons.) The voltage across the capacitor will equal that across the battery. Furthermore, the bottom plate will have a surplus of electrons and will be negatively charged. The top plate will have a deficiency of electrons and will be positively charged.

We can find out just how much charge the capacitor is holding by using the simple equation  $Q = CV$ . This means that the charge in *coulombs* (one coulomb = 6.281 billion

ion billion electrons!) is equal to the applied voltage times the capacitance in *farads*. (The farad, which is the basic unit of capacitance, is so named to honor the British scientist Michael Faraday.) Thus we see that the capacitance of a capacitor is a measure of how much charge it can hold. And this presents the key to understanding the capacitor—it is an *energy storing* device. If we open the switch in Fig. 1, the voltage across the capacitor remains the same. No current will flow through the dielectric to *discharge* the capacitor if the dielectric is a good insulator. So, the charges are trapped on the metal plates. We could attach a light bulb (or any other load) across the capacitor and it would behave like a battery until enough current flowed from one plate to the other to compensate for the charge unbalance. At that point, the voltage across the capacitor would be zero, because its charge would have been depleted.

Among the factors that determine capacitance are the area of each plate, the spacing between the plates, and a quantity called the *dielectric constant*. If the plates are made larger (increased area), the capacitance will rise. When the plates are moved further apart, capacitance decreases. If an insulating medium with a dielectric constant of 1 (air) is replaced with one having a constant of 2 (paper), capacitance will be doubled.

In electronic applications, the farad is much too large a unit of capacitance. The more common units are microfarads ( $\mu\text{F}$  or  $10^{-6}$  F) and picofarads (pF or  $10^{-12}$  F). Another

quantity of interest is the *leakage resistance*. We noted before that a charged capacitor will hold its stored charge until a load is placed across it. But that represents an idealized situation. No dielectric is a perfect insulator, but can be represented as a resistor in parallel with the capacitor. This leakage resistance allows a leakage current to flow through it which tends to discharge the capacitor. In most cases, we want this resistance to be as high as possible—on the order of many megohms—to make the capacitor a good storage place of electric charge.

**DC and AC Behavior.** If we apply a dc voltage across a capacitor, we note a transient charging current which stops as soon as the capacitor has fully charged. In other words, once the capacitor has charged, it acts like an open circuit for dc signals, and will block them. But the capacitor behaves differently in ac circuits. Without getting into details, suffice it to say that a capacitor displays *reactance*, which is an opposition to the flow of ac. Although reactance is measured in ohms, it is not a true resistance. A reactance does not consume any power by converting it into heat, as a resistance does, but rather returns power to the source of the ac signal. Capacitive reactance varies inversely with frequency and capacitance. That is, when capacitance is increased, reactance decreases, and if frequency is increased, the reactance grows smaller. The formula for capacitive reactance is  $X_c = 1/(2\pi fC)$ , where  $X_c$  is measured in ohms,  $f$  in hertz, and  $C$  in farads. Using this formula, we find that a 1- $\mu\text{F}$  capacitor has 160 ohms of reactance at 1000 Hz, and 16 ohms at 10,000 Hz.

One example of capacitive behavior is in blocking and coupling, which is one of the most common ways in which a capacitor is used. Tubes and transistors can amplify ac signals, but to work properly, certain dc voltages must be applied to them. The plate of a tube can be set at a dc level of several hundred volts in a high-power

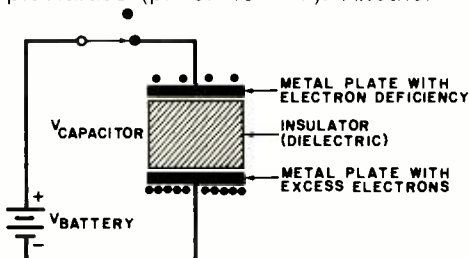

Fig. 1. The capacitor is basically a charge storing device.



amplifier. But we must take the ac output at this point without disturbing the dc level. So, we install a coupling capacitor at the plate. It acts as an open circuit to dc, but allows the ac signal to pass through it.

Of course, the capacitor must be chosen so that its reactance is low for the signal frequency, and its leakage resistance is high enough not to disturb the dc operation of the tube, as well as to prevent appreciable dc from flowing into the next stage or the load. Finally, we must choose a capacitor that can withstand the highest dc voltage that would exist across it. That is, it must have a sufficient *working voltage* rating. If this voltage is exceeded, the dc can arc over—as it does in a spark plug—with disastrous consequences.

**Capacitor Types.** Now that we know how a capacitor basically works, let's take a look at the various packages they are put in, and what materials are used to make them.

There are two major classes of capacitors: *polarized* (electrolytic) and *nonpolarized* types. The main factor that determines in which class or sub-class a capacitor falls is the dielectric material used. Nonpolarized capacitors can be inserted into a circuit without regard for which plate is positively charged, or which is negatively charged. Polarized capacitors are marked with one plate positive and the other negative. They must be inserted so that the positive plate is always at a higher potential (referenced to ground) than the negative plate.

Without delving too deeply into the peculiarities of each type, we can summarize the characteristics of non-polarized capacitors as follows:

- *Paper dielectric* capacitors are the least expensive type to make. They cannot be used at frequencies much above 1 MHz, and are found primarily in audio circuits.

- *Organic film* types, such as polyester, Mylar, polystyrene, and polycarbonate capacitors, are intermediate in cost, offer large leakage resistance ( $10^{10}$  to  $10^{14}$  ohms), and greater capacitance per unit volume than paper components. These dielectrics can also be used at higher frequencies than paper capacitors.

- *Ceramic dielectric* capacitors are widely used because they are fairly inexpensive, can be used in audio as well as r-f circuits (up to tens of MHz),

and are available in capacitances from 1 pF to 1  $\mu$ F, with working voltages up to several thousand volts. Leakage resistance is high, and they are marked for specific temperature coefficient information from *P* (positive, meaning increased temperature raises capacitance), to *N* for negative, in parts per million per degrees centigrade (ppm/ $^{\circ}$ C). The designation *NPO* means negative-positive zero coefficient (virtually no change in capacitance over the  $-25^{\circ}$  C to  $+85^{\circ}$  C range).

- *Mica* or *silver mica* types offer excellent response into the vhf re-

gion, high leakage resistance, and tight tolerance (as low as  $\pm 1\%$ , as opposed to  $\pm 10\%$  or  $\pm 20\%$  for other nonpolar capacitors). Working voltages can be made very high—on the order of several kilovolts. They are more expensive than ceramic capacitors, but are often used in precision and r-f applications, where increased cost is justified by superior performance.

- *Glass* is a dielectric that is superior to mica in many ways. *Glass capacitors* can be made to very close tolerances, and have excellent fre-

# handic CB

TALKS BETTER... LISTENS BETTER... and it's QUIETER!

**SPECIAL  
FREE OFFER.  
SAVE \$200<sup>00</sup>**  
APPROX

## Precision matched, high performance mobile antenna FREE with purchase of the **handic 235** 23 channel CB.

handic, the one-of-a-kind Swedish designed CB now gives you a rare opportunity to own this advanced equipment at real savings. It's handic's unique engineering concepts that have generated specifications up to 250% better than FCC requirements — without frills, gimmicks or "flash-in-the-panel" lighting. The result is the cleanest CB performance around — performance that's conquered the roughest operating conditions Sweden could muster. Take advantage of the special offer. See your dealer now. You'll save money and own a handic CB with a precision matched handic antenna — a combination that's second-to-none in quality. handic... the orange color tells you it's outstanding. The performance proves it.

handic CB radios include: mobile/base transceivers, handheld portables, scanners with FM radio option, antennas, microphones, selective call and a full line of accessories.

**handic**  
USA

14560 N.W. 60th Ave., Kennedy Bldg  
Miami Lakes, Fla 33014  
(305) 558-1522  
In Canada: Scotcomm Radio Inc.,  
Quebec

handic Model MA-1  
Mobile CB Antenna  
**SPECIAL DESIGN**  
for Extended Range Performance

- Optimum radiation pattern
- Top-loaded coil
- Quick thumb-screw SWR adjustment
- Fold-down construction
- Precision crafted in Scandinavia

**Offer expires November 15, 1976**  
or on previous notification by  
handic of USA, Inc.

Send For FREE Catalog!

SWEDISH-DESIGNED DEPENDABILITY

CIRCLE NO. 31 ON FREE INFORMATION CARD

# The better the training the better you'll

Send for  
**FREE**  
illustrated  
career  
guide

NTS guide  
to careers in  
Electronics

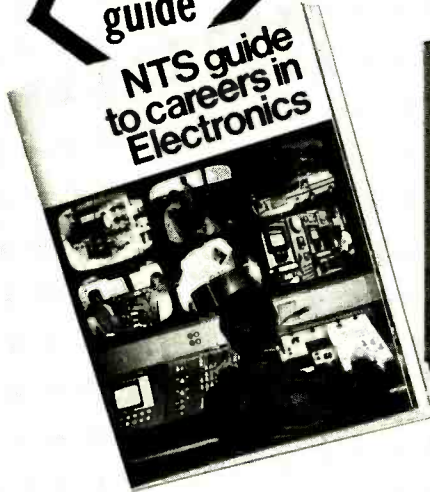

IN-CIRCUIT TRANSISTOR TESTER

COMPU-TRAINER

TROUBLESHOOTER  
VOM

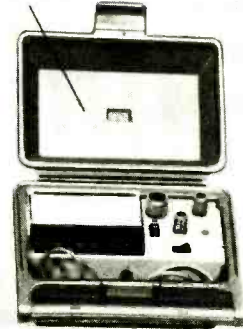
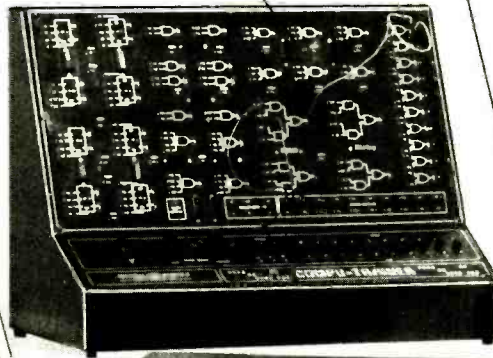

SOLID-STATE  
OSCILLOSCOPE

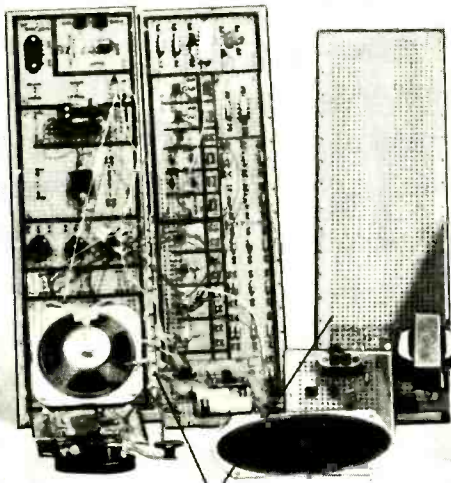
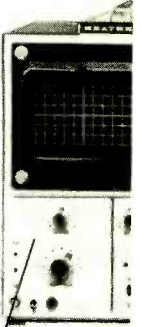

ELECTRO-LAB



(Simulated TV Reception)

As an NTS student you'll acquire the know-how that comes with first-hand training on NTS professional equipment. **Equipment you'll build and keep.** Our courses include equipment like the **NTS/Heath Digital GR-2000 Solid State color TV** with first-ever features like silent varactor diode tuning; digital channel selection, (with optional digital clock), and big 315 sq. in. ultra-rectangular screen.

Also pictured above are other units — 5" solid state oscilloscope, vector monitor scope, solid-state stereo AM-FM receiver with twin speakers, digital multi-meter, and more. It's the kind of better equipment that gets you better equipped for the electronics industry.

This electronic gear is not only designed for training; it's field-type — like you'll meet on the job, or when you're making service calls. And with NTS easy-to-read, profusely illustrated lessons you learn the theory behind these tools of the trade.

**Choose from 12 NTS courses** covering a wide range of fields in electronics, each complete with equipment, lessons, and manuals to make your training more practical and interesting.

**Compare our training; compare our lower tuition.** We employ no salesmen, pay no commissions. You receive all home-study information by mail only. All Kits, lessons, and experiments are described in full color. Most liberal refund policy and cancella-



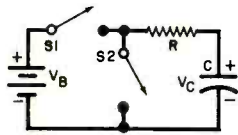

Fig. 2. Simple RC circuit.

quency response and leakage characteristics. They are also rather expensive.

The major limitation of all these nonpolarized capacitors is the amount of capacitance that can be packed into a container of reasonable volume. Up to about a tenth of a microfarad or so, packages are fairly small. But they become unwieldy as 1  $\mu\text{F}$  is approached. For really large capacitances in small cans, we must use polarized or electrolytic capacitors.

These devices consist of two metallic electrodes separated by an electrolyte (hence their name). When a voltage is impressed across the electrodes, a thin film of nonconducting oxide is produced by chemical (electrolytic) action to form the dielectric. The rest of the electrolyte conducts fairly well, so the two electrodes are effectively separated only by the thin

oxide layer. As we noted earlier, closely spaced plates mean high capacitance, and this is why the electrolytic capacitor has such high capacitance ratings. However, extreme care must be taken to insure that the proper polarizing voltage is applied, because reverse or excessive forward voltages can irreparably damage the capacitor.

The two most common types of electrolytic capacitors are aluminum and tantalum. They consist of either a foil (aluminum or tantalum) or a dry slug (tantalum). Foil units contain a liquid or gel electrolyte between the foil anode and the case that is in continuous contact with the oxide layer, and that participates in its formation. Slug-type capacitors employ a solid semiconducting electrolyte, and the anode is a sponge-like porous metal slug. In dry tantalum capacitors, manganese dioxide is commonly used as the electrolyte.

Dc leakage is an important factor in electrolytic capacitors. Some of them are quite leaky. Although this is tolerable in certain applications, it is most undesirable in others.

Tantalum capacitors generally display less leakage than aluminum

components, and are often used because of this. Also, tantalums can be made to  $\pm 20\%$  or even  $\pm 10\%$  tolerances. Aluminum capacitors often have a  $+100\%$ ,  $-50\%$  tolerance, which can rule out their use in certain circuits. Finally, aluminum electrolytics are frequency limited. They are useful up to 50 kHz at most, so are found mainly as filters in power supplies and as coupling or bypass capacitors (passing ac signals to the next stage or shunting them to ground) in audio circuits.

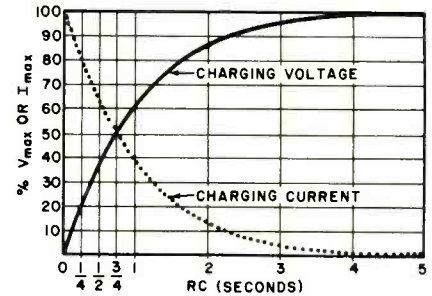

Fig. 3. Universal curves of charging voltage and current versus time. Computer-grade electrolytics are found in power supplies because they can store large amounts of energy. You can find aluminum and computer grade capacitors rated at up to 10,000

# YOU CAN BE SURE

## MORE TIMES IN MORE CIRCUITS WITH SENCORE DIGITAL MULTIMETERS

### SENCORE

A NEW BREED OF DVM's BACKED BY 25 YEARS OF ALL AMERICAN CRAFTSMANSHIP, WITH SIX EXCLUSIVE FEATURES, SO YOU CAN BE MORE SURE, MORE OFTEN . . . . . AND ALL WITH HI & LO POWER OHMS FOR MEASURING ACCURATELY IN SOLID STATE CIRCUITS.



**1** ONE THIRD LESS CIRCUIT LOADING to make you sure that you are affecting the circuit being tested as little as possible for more accurate measurements. Sencore digitals are 15 megohm, others are 10 megohm.



**2** 2000 DCV range to make you sure that you can measure TV boost volts, scope voltages, medical equipment, etc. Other digitals stop at 1000 volts. High voltage probe extends measuring capabilities to 50 KV.



**3** PROTECTED INSIDE AND OUT so you can be sure that your meter is working and not in the repair shop. Drop it from 10 feet, apply 1000 volts overload and even apply volts on ohms accidentally and Sencore digitals keep right on working.

$\mu\text{F}$  or more and several hundred working volts, but today the high-voltage components are getting rare because solid-state circuits don't require the dc voltage levels that tubes do. Tantalum capacitors have ratings of a fraction of a microfarad up to 700  $\mu\text{F}$  or so. Their voltage ratings generally lie between 3 and 50 volts.

**Variable Capacitors.** So far we have talked only about fixed capacitors. That is, those capacitors whose capacitance is set in the manufacturing process. But *variable* capacitors are also very important. Every tuning-dial radio has at least one. The most common type of variable capacitor uses air as the dielectric, and has two sets of interleaved

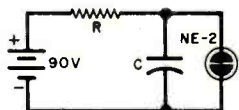

Fig. 4. Basic relaxation oscillator.

plates. One set, called the stator, is bolted to the frame of the capacitor. The other set, the rotor, is attached to a shaft that allows the two sets to be meshed (maximum capacitance), or

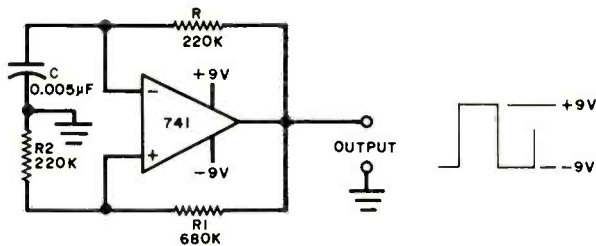
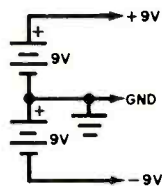

Fig. 5. Oscillator using an op amp as comparator produces high-amplitude square waves.



fully unmeshed (minimum capacitance), or anything in between. The capacitor is described by these two values, as well as its air gap (spacing between plates) and maximum working voltage. The latter two specifications are important in transmitting applications, where high-voltage r-f is present. In fact, sealed vacuum capacitors are available for high-power operation.

Other types of variable capacitors are *trimmers* and *padders*. They are used to fine-tune a network, and usu-

ally have screwdriver adjustments. They can have air, mica, plastic, or quartz dielectrics, and can take the appearance of a small piston and cylinder, a small box, or two plates (one above the other) on a ceramic body.

All variable capacitors are noted for their small capacitance values. The typical tuning capacitor in an AM radio is rated at 365 pF maximum. Trimmer and subminiature tuning capacitors can have *maximum* capacitances of less than 10 pF! Remember, though, that capacitance isn't everything, and



**DVM36 \$148**  
3 1/2 digit LED display,  
.5% DCV accuracy,  
battery or AC operated



**DVM32 \$198**  
3 1/2 digit LED display,  
.5% DCV accuracy,  
battery or AC operated  
with automatic battery saver



**DVM38 \$348**  
3 1/2 digit LED display,  
.1% DCV accuracy,  
AC operated, auto-ranging,  
auto-zero, king size pushbuttons



**BATTERY SAVING FEATURES WHEN INSTRUMENT IS NOT IN USE** so you can be sure that your meter will be ready the next time you need it. Push the button on the probe on the DVM35 and DVM36 and only then do you start drawing current from your battery. An automatic patented circuit does the same job for you automatically when you apply voltage to the DVM32. The DVM38 is AC operated.



**10 DAY FREE TRIAL** to be sure that Sencore digitals are all that we say they are. Simply march into your Sencore distributor and ask for a free trial or pay cash with a promise of a 10 day money back guarantee, if not 100% satisfied. Or, write Sencore, and we will see that our distributor contacts you.



**100% MADE RIGHT LIFETIME GUARANTEE** so you can be sure your meter was made right. If at any time you discover that a Sencore DVM was not made right, Sencore will make it right, parts and labor free of charge, for the lifetime of the product.

Plus other "make sure" features such as - direct reading with no parallax error - no effect from magnetic fields such as motors & RF fields - lab accuracy with high resolution - auto-polarity auto-zeroing and auto-ranging on the DVM38 - and you can see why you can be sure more times, in more circuits, than with any other multimeter on the market today - and for less money than old fashioned analog meters.

**SENCORE** 3200 SENCORE DRIVE  
SIOUX FALLS, S.D. 57107

# The \$750 alternative.

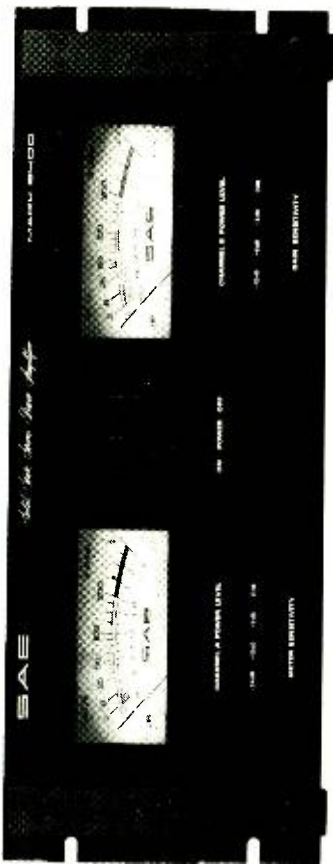

SAE 2400 Professional Dual-Channel Power Amplifier

- 200 Watts RMS, per channel, both channels driven into 4 or 8 Ohms from 20Hz to 20KHz at no more than 0.05% Total Harmonic Distortion.
  - 0.05% IM into 4 or 8 Ohms
  - (signal to noise) greater than 100dB
  - plug-in board modules
  - forced air cooling
  - only 11" deep
  - weighs less than 42 lbs.
  - superb construction using only the finest materials and component parts
  - available in black rack mount (as shown) or our traditional satin gold and black
- You'd have to look a long time to find a power amplifier that delivers this much value.



Scientific Audio Electronics, Inc. PE10/76  
 P.O. Box 60271, Terminal Annex  
 Los Angeles, California 90060  
 Please send me the reasons (including available literature) why the SAE 2400 Professional Amplifier is the "\$750 Alternative."

NAME \_\_\_\_\_  
 ADDRESS \_\_\_\_\_  
 CITY \_\_\_\_\_ STATE \_\_\_\_\_ ZIP \_\_\_\_\_

variable capacitors are indispensable in most communications equipment.

**Combining R and C.** When a resistor and capacitor are connected together, several interesting things happen. First, the relative magnitudes of  $R$  and  $C$  affect how quickly the capacitor will charge up. Second, the combination can act as a filter, passing high or low frequencies, depending on how the  $RC$  pair is connected across a signal source. Let's look at the dc charging action first.

The product of  $R$  in ohms and  $C$  in farads is called the  $RC$  time constant, and is symbolized by the greek letter tau ( $\tau$ ) and expressed in seconds or microseconds ( $\mu s$ ). The time constant appears in many descriptions of the frequency response of oscillator and filter circuits, and is also important to the action of many pulse circuits. It is most easily understood as the factor that determines how fast a capacitor can charge through an effective resistance. From here we can determine the time  $T$  or period required for one complete cycle of oscillation, and thus the frequency.

If we were to close switch  $S1$  of the circuit in Fig. 2, and monitor the voltage across the capacitor with a voltmeter or oscilloscope, we would see that the voltage starts to build up rather quickly, but then the rate of increase drops off. Graphing the voltage against time or taking a snapshot of the scope trace would yield the solid-line curve shown in Fig. 3. It is an exponential curve that is universal in terms of the  $RC$  time constant.

We call the curve an exponential one because we can express the voltage across the capacitor by the equation  $V_c = V_B (1 - e^{-t/\tau})$ , where  $V_c$  is the voltage across the capacitor,  $V_B$  is the battery voltage,  $t$  is the time in seconds after the switch is closed,  $e$  is the base of natural logarithms (approximately 2.718), and  $\tau$  is the time constant in seconds. The equation tells us that at  $t = \tau$  seconds (as the switch is closed), the voltage across the capacitor is zero. After the number of seconds equal to one time constant,  $V_c = V_B (1 - e^{-1})$ , or  $V_c = V_B (1 - 1/2.718)$ . Solving this equation, we get  $V_c = 0.63 V_B$ , or, after one time constant, the voltage across the capacitor has reached 63% of the battery voltage.

After one time constant, the capacitor charges more slowly. We can see from the graph that after two

# plug in and go soldering



WITH THRIFTY MARKSMAN IRONS

BY Weller®

Pre-tinned tips for instant action. Five different ratings for technicians and hobbyists. Heat- and impact-resistant handles grip comfortably. Premium, stainless steel barrel for strength, corrosion resistance, and more even temperatures. Cone shape, screw driver, chisel tips; Soldering Kit, Hot Knife Kit for wire stripping and plastic cutting. Full-view card pack lets you see and read about these UL-listed, factory-pre-tested irons before you buy.

See your local distributor or write ...

Weller-Xcelite Electronics Division



The Cooper Group

P. O. BOX 728, APEX, NORTH CAROLINA 27502

CIRCLE NO. 79 ON FREE INFORMATION CARD

POPULAR ELECTRONICS

## BULLET ELECTRONICS

P.O. BOX 19442P • DALLAS, TEXAS 75219

### PS-01 POWER SUPPLY KIT

IMAGINE! A power supply with a well filtered, regulated output in three voltages. The PS-01A has quality IC regulators, semiconductors and components. The transformer is custom designed and well made. Features 10mv load regulation.

#### YOU GET:

Drilled and plated board  
Complete kit of components  
Heatsinks +5V @ 1.5A  
Complete instructions ±15V @ 200MA

**\$14.95**

NOTE: +5 and ±12VDC supply is available at same price. Order PS-01/B.

BUILD A COMPLETE CDI IGNITION KIT AT A FRACTION OF THE COST OF OTHER UNITS. A special buy allows us to sell the complete kit at this low price! Up to 40,000 volts from your present ignition without changing the coil. Simple connections.

INCLUDES: Special toroid transformer  
Drilled and plated board  
Complete instructions  
All resistors and caps  
All semiconductors

**\$9.95**

(Does not include heatsink or case.) For 12V negative ground systems.

### REGULATED 5 VOLT TTL POWER SUPPLY KIT

Small (1 1/4 x 1 3/8 x 2 3/8")

Complete with drilled and plated board

Includes all components

The PS-02 is a small, low ripple, regulated, short proof power supply kit that can supply power for 10 to 12 TTL IC's. (350 MA Continuous). \$4.95 or 3/\$12.50

### 10 WATT WARBLE ALARM KIT

A REAL SCREAMER! Emits a piercing dual tone blast that is impossible to ignore. Great for burglar alarms, signal devices or just a toy. Complete with drilled and plated pc board. Does not include a speaker or power switch. (3-15 volts) \$2.50

### AUDIBLE CONTINUITY TESTER KIT

A neat little kit that has a hundred and one uses around the shop and home. You can afford to keep several around at this price!

#### USES:

Code Practice Oscillator  
Continuity Checker  
Transistor, diode or LED checker  
Tone varies with resistance  
Requires 3 to 6 volt batteries (not included)

**\$1.95**

### HEATSHRINK TUBING ASSORTMENTS

A very useable assortment of various 5" pieces of 1/8" to 1/2". 20 pct. for .59

#### TRANSISTORS

2N2222  
2N3904

(unmarked)  
12/\$1.00

#### SPECIAL MADE SMALL DIAMETER

12/\$1.00

50ohm COAX  
Low loss poly-foam inner. 1/8" O.D.  
100 ft. roll \$3.99

SORRY - NO COO'S.  
CHECK OR M.C.

Foreign orders add 10%  
(20% for air-mail)

SEND A STAMP FOR A  
FREE CATALOG

CIRCLE NO. 13 ON FREE INFORMATION CARD

COMING UP IN  
THE NOVEMBER

## Popular Electronics®

Build a CB/HAM  
Selective Caller

Protection Methods  
for Modern Power  
Supplies

The Slide Syncer  
Audio-Visual  
Programming Device

Test Reports:

Spectro-Acoustics 210 Stereo  
Equalizer  
Pickering XV-15/525E Stereo  
Cartridge  
Siltronix "Mohawk" CB AM Mobile  
Transceiver

OCTOBER 1976

time constants the capacitor voltage is about 86% of the battery voltage, increasing to about 98% after four time constants. Theoretically, it would take the capacitor an infinite amount of time to charge to the full battery voltage; but, as a practical matter, we will consider the capacitor to be fully charged after 5 time constants have passed. Unlike voltage, charging *current* decreases with time. It is shown as the dotted curve in Fig. 3, and essentially is a mirror image of the voltage curve. We can see that charging current never stops (it would take an infinite time to do so), but after 5 time constants it is less than 1% of its initial turn-on value.

In the theoretical case shown in Fig. 1, the capacitor will hold its charge forever after it is disconnected from the voltage source, if its leakage resistance is infinite. Although this is never the case in practical components, good capacitors will hold most of their charge for a reasonably long time. (That's why it's dangerous to handle line powered electronic equipment *after power has been removed* if you haven't discharged the filter capacitors with a shorting stick.) But what happens if we allow capacitor *C* to discharge through *R*? We can do this by opening *S1* in Fig. 2 and then closing *S2*—which has been open up to this point.

If we use our oscilloscope or voltmeter to monitor the voltage across the capacitor, we'll see that it decreases exactly the same way as the charging current did. That is, after one time constant the voltage will have decreased to 37% of its open circuit value. As more time passes, the capacitor discharges more slowly. After two time constants, voltage is down to 14%; after three time constants it's at 5%; after four, 2%; and after five, slightly less than 1%. Although a theoretical, ideal capacitor will never fully discharge, we can say practically that it has done so after five time constants have elapsed.

**RC Relaxation Oscillators.** One circuit that is directly governed by the *RC* time constant is the *relaxation oscillator*. It depends on the alternate charging and discharging of a capacitor through a resistance. Probably the simplest relaxation oscillator you can build is a neon lamp flasher, shown in Fig. 4. The circuit is similar to that of Fig. 2, but we have added a neon bulb in parallel with the

# The Simple Solution to the I/O enigma.



The **3P+S** module from **Processor Technology** is the most versatile input-output card for your Sol, IMSAI, or Altair system. It has **two 8-bit parallel I/O ports**, with full handshaking logic, **and a serial I/O port**. All on a single card.

Check this spiffy set up. Run a keyboard and a paper tape reader into your 8080 system; then, output a TV terminal and a tape punch, all via the 3P+S. And, you can still **simultaneously** run a modem (Telephone Coupler) in and out. We could write pages about the 3P+S' talents. We did, in fact. You can get our **59-page 3P+S Owner's Manual** (with schematics and applications) for **\$4.95**. If, then, you do buy our 3P+S, we'll refund the \$4.95.

### 3P+S I/O Module, Kit Price

with premium grade,  
low-profile sockets for  
every IC, **\$149**

Write Us about all  
our Sol/IMSAI/Altair  
compatible plug-in  
modules.

**Processor  
Technology**  
6200-T Hollis Street  
Emeryville, CA 94608

# ROCKWELL A4001 I.C.

## ELECTRONIC SLIDE RULE SCIENTIFIC CALCULATOR KIT !!

Kit Includes: Rockwell A4001 IC  
HP 9 Digit LED Readouts  
Complete Keyboard with Case  
PC Board with all Electronic Parts  
Instructions and Batteries



Dimension: 32.5mm(H) x 77mm(W) 145mm (L)  
1 9/32 in (H) x 3 1/32 in (W) x 5 23/32 in (L)

PLEASE SEND CHECK OR MONEY ORDER TO:

**FORMULA INTERNATIONAL INC.**

12603 CRENSHAW BLVD., HAWTHORNE

CA. 90250

PHONE: (213) 679-5162

### SPECIFICATION

- \* 9 digit HP Red Led Displays
- \* 8 digits capacity for data entry or results
- \* (10<sup>-8</sup> ~ 10<sup>8</sup>)
- \* Full floating point
- \* Dome keyboard for excellent response and preventing double entry input

### BASIC FUNCTION

- \* Algebraic mode operation
- \* Constant operations
- \* Repeat Operations
- \* Chain operations
- \* Change sign operation
- \* Display and Y register exchangeable
- \* One accumulating memory
- \* Display and memory exchangeable

### SPECIAL FUNCTION

- \* Trigonometric functions (sin, cos, tan)
- \* Inverse trigonometric functions (sin<sup>-1</sup>, cos<sup>-1</sup>, tan<sup>-1</sup>)
- \* Radian or degree selectable
- \*  $\pi$  constant
- \* Logarithms (ln, log)
- \* Anti-logarithms (e<sup>x</sup>)
- \* Power functions (y<sup>x</sup>)
- \* Reciprocal (1/x)
- \* Square root ( $\sqrt{x}$ )
- \* Display recall

**ONLY \$28.<sup>50</sup>**

Plus handling & shipping \$1.50  
Cal. residents add 6% Sales Tax.

NI-CD Batteries \$1.25 each  
(Use 4 per unit)  
AC Adapter for Unit \$4.50 ea.

CIRCLE NO. 28 ON FREE INFORMATION CARD

capacitor. Until a certain voltage threshold is reached, the bulb acts like a very high resistance, practically an open circuit. Once the threshold is exceeded, the bulb turns on (conducts current and glows). In its on state, the bulb acts like a low resistance and will conduct very heavily unless a series current-limiting resistor is used with it. For common neon bulbs, the turn-on threshold is about 70 volts.

When the battery is connected, the capacitor starts charging up at a rate dependent on the time constant. After about 1.3  $RC$  seconds have passed, the bulb suddenly turns on and discharges the capacitor very quickly. When the capacitor is discharged, no more current can flow through the bulb so it turns off. Then the capacitor begins to charge again. Oscillations, which we perceive as the flashing of the neon lamp, will continue as long as sufficient voltage is applied across the  $RC$  combination. You can duplicate this circuit very easily. Use an NE-2 neon bulb, a 90-volt photoflash battery, a small capacitor (0.1  $\mu\text{F}$  or less at 250 WVDC), and a large resistance (over two megohms). You can vary the flashing rate by changing  $R$  or  $C$ , or both. Just stay within the guidelines suggested above.

A more up-to-date relaxation oscillator is shown in Fig. 5. It uses the 741 op amp as a comparator, and produces high-amplitude square waves. Here's how it works. Assume a positive output voltage appears when we initially apply power. This charges  $C$  through  $R$  to a positive voltage. Charging proceeds until the voltage across the capacitor exceeds that applied to the noninverting (+) input by the voltage divider  $R_1R_2$ . At this point the comparator produces a large negative output voltage, which discharges the capacitor through  $R$  and starts to charge it to a negative voltage. When the voltage across the capacitor exceeds that at the (+) input of the op amp, the output voltage goes positive, and the process repeats itself.

The  $RC$  time constant controls the duration of the high ( $t_1$ ) and low ( $t_2$ ) output durations. The presence of the voltage divider and the value of the power supply voltage also play a role. For the values given in Fig. 5, the period  $T$  for a complete oscillation equals the sum of  $t_1$  and  $t_2$ , or  $T = 0.9 RC$ , and the frequency  $f = 1/T = 1/990 \times 10^6$ , or approximately 1000 Hz. If we increase  $C$  to 5  $\mu\text{F}$ , we get about one pulse per second.  $\blacklozenge$

# Superb price!!!! Supreme quality!

6-DIGIT  
FREQUENCY COUNTERS

**69<sup>95</sup>**  
(30mHz Kit)  
\$99.95 assembled

**119<sup>95</sup>**  
(250 mHz Kit)  
\$139.95 assembled

A counter-offer you can't refuse! It's rock-bottom price and sky-high quality make it your best possible buy! We've proved it to thousands. Let us prove it to you!



Perfect for: CBers, Hams, Service Techs, & Experimenters!

- HAM, CB, & COMMERCIAL BANDS • WIRED & TESTED AVAILABLE • 100HZ READOUT • 6 DIGITS
- CRYSTAL TIME-BASE • 1Hz OPTIONAL • MASTER CHG. / B. AMERICARD OK • ADD \$2 SHIPPING

## Hufco

Incredible counters starting at \$45.95 are also available!

All counters can be factory wired and tested. Write or call today!

Box 357, Dept. 52, Provo, UT 84601 (801) 375-8566



# Operation Assist

If you need information on outdated or rare equipment—a schematic, parts list, etc.—another reader might be able to assist. Simply send a postcard to Operation Assist, POPULAR ELECTRONICS, 1 Park Ave., New York, NY 10016. For those who can help readers, please respond directly to them. They'll appreciate it. (Only those items regarding equipment not available from normal sources are published.)

**Hallicrafters** Model SX-28 receiver, US Navy version RBY. Manufactured in the late '50's. Any available information. A.H. Heidorn, 795 Yale Dr., Barstow, CA 92311.

Back issue (April 1971) of PE needed. Arthur Kneller, 84 Bennett Avenue, Neptune City, NJ 07753.

**Vogue Inst. Corp.** (Richmond Hill, NY) Model 880 Printer. Manual or schematics. W.M. Lowe, 3312 Bellevue Ave., Cheverly, MD 20785.

**Scientific Development Corp.** (Watertown, MA) MINIVAC 6010 relay computer. Operation manual. Robert Todd, 2720 E. 69th Place, Tulsa, OK 74135.

**Brush Instruments** Ultralinear oscillograph, Model RD-2662-00, Serial 125. Schematic and/or operation manual. Paul D. Witman, 2794 Harrington Rd., Simi Vly, CA 93065.

**Mercury** Model 4000 transistorized high impedance multimeter. Operation manual and/or schematic. Haydn J. Thomas, Apt. 7B, 120 E. 34th St., New York, NY 10016.

**RCA** station allocator stock, no. 171, 1942 model used to reset pushbutton radios. Need schematic from inside bottom cover. Bailey, 426 Slocum Avenue, Neptune, NJ 07753.

**Beckman** Ultrahmmeter. Instruction sheet or manual. Jacob Zager, 1 Mason Street, Hudson, MA 01749.

**Precise Dev. Corp.** Model 3052 D/rack mount dual trace oscilloscope. Schematic and/or service and calibration data. John F. Twitty, 218-15 136 Avenue, Springfield Gardens, NY 11413.

**Electronic Measurement Corp.** Model 300 VTVM. Schematic and/or service manual. **Dumont** Model 185-A electronic switch and square wave generator. Schematic, service and operations manuals. **Electronic Beam Corp.** (Yonkers, NY) CRT checker and reactivator. No model number on case. Schematic, parts list, operation manual. Jack Manzik, 2810 Genesee Rd., Lawtons, NY 14091.

**Westinghouse** Model H-196 TV receiver chassis V-2130 circa 1948-9. Horizontal Sync Discriminator transformer needed, primary 42 ohms CT, secondary part no. V 5935, or substitute. J.B. Swartz, R.R. 1, Box 1557BC, Camden-ton, MO 65020.

**Jackson Models** CRO-2 oscilloscope, 640 test oscillator. Schematics and operation manuals needed. R.E. Hutchinson, Rt. 3, Box 236, Arkadelphia, AR 71923.

**Fairchild Camera and Instrument** Model 7050 DVM. **Heath** Model OM-2 oscilloscope. Schematics and manuals needed. Larry Pearson, 1053 Hilltop Road, Warminster, PA 18974.

**Knigh Kit** KN 330 AM/FM stereo receiver Serial 95DU 060. Schematic or power transformer data needed. Don Os-mund, WB9LWN, 533 Brainerd Avenue, Libertyville, IL 60048.

**Polycom** Model 2 transceiver. **Crown** Telephone Valet Model CTA-4400 K-85. Instruction books and/or schematics. Ian G. Tervet, Rte. 1, Box 45B, Littlerock, CA 93543.

**Texas Instruments** Model TI-3500 alculator. Schematic needed. Jim Walton, 1711 N. Mills Ave., Orlando, FL 32803.

**U.S. Navy** Model RBB-1 receiver covering 0.5 to 9 MHz, built by RCA. Need schematic, any other information, and a source for the male power connector. Warren E. Green-berg, 145 Cottage Rd., Roxbury, MA 02132.

**Lafayette** Model KT-208 signal generator. Need audio choke or substitute information, or a defective unit for parts. **Echo-Zonic** Model 109-B echo and reverb unit. Need schematic and set-up info. **Paco** T-60 tube tester. Meter needed. **RAC** tune-up meter. Need type numbers for all semiconductors. Nicholas I. Oshana, Jr., 141 Trol-ley Crossing Lane, Middletown, CT 06457.

**Philco** Model UN-2620-WH 15-inch B&W portable TV. Schematic, parts list, pc board artwork, and any other info. Michael S. Toth, Rt. 2, Box 40-A, Federalsburg, MD 21632.

**Hallicrafters** HT-6 transmitter. Need oscillator and power amplifier coils, or sufficient data to homebrew them. Craig Hinton, 5004 Amy Circle, Omaha, NB 68137.

**Hallicrafters** Model SX28 Super Skyrider. Schematic diagram needed. Kenneth Hughes, 4984 Connaught Ave., Montreal, P.Q., Canada H4V 1X3.

**Precise** Model 300 oscilloscope. Schematic, instructions, and/or service manual needed. Daniel Evans, Box 4227, Huachuca City, AZ 85616.

**Chicago Coin Co.** "Playtime" pinball machine model 363 300. Schematic needed. M. Hunt, Cedar Hills, R.D. 3, Cambridge, OH 43725.

## Answer to Quiz on p 71.

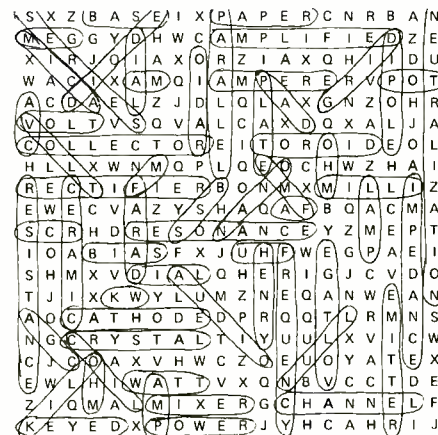

# Consumer Tested Remedy for Sick Car Performance Sparks New Life in Pre-1975 Cars.

Owners of pre-1975 cars get better performance with less maintenance when they install one of the Mark Ten C.D. Electronic Ignition Systems. In fact, thousands of users testify the Mark Ten has noticeably improved their automobile's performance. As a California doctor stated after using the Mark Ten for 95,000 miles. "...I can 'feel' the difference in performance between my conventional ignition and the Mark Ten..."



Mark Ten Systems\* spark each plug with 50,000 to 60,000 volts in secondary output compared to a mere 25,000 volts in standard and most pointless systems. This means dramatic increases in acceleration and general engine performance, and substantial increases in gasoline mileage. Points will last the lifetime of the rubbing block. Spark plug life is extended three to ten times due to the hot spark generated by the Mark Tens, which eliminates fouling and cleans dirty plugs. And the Mark Ten Systems virtually eliminate at least 2 out of 3 tuneups! Look at what Delta Customer P.S. from New York wrote, "...I might add that I had another unit of yours that has been on three cars so far. Each of the cars was driven about 50,000 miles

before it was turned in. Not one of the cars ever had a new set of points, new plugs or a tune-up.

Now its on the fourth car with 20,000 miles on it and going strong." The result? BIG SAVINGS!

Send today for your copy of the new Delta brochure and learn how a Mark Ten System can spark your car into new life.

\*Only Delta Products offers a full line of C.D. ignitions: The Mark Ten and Mark Ten B, available assembled or in kit form; and the Mark Ten C, assembled only.

**DELTA PRODUCTS, INC.**  
 P.O. Box 1147  
 Grand Junction, Colo. 81501  
 (303) 242-9000 Dept. PE

I want to know more about Mark Ten CDI's. Send me complete no-nonsense information on how they can improve the performance of my car.

Name \_\_\_\_\_  
 Address \_\_\_\_\_  
 City \_\_\_\_\_ State \_\_\_\_\_ Zip \_\_\_\_\_

# PROFESSIONAL DISCOUNTS

## Texas Instruments electronic calculator

SR-50A	\$47.95	Bus. Anst	\$ 44.95
SR-51A	62.95	SR-52	229.95
SR-56	89.95	PC-100	229.95
Libraries	26.00	2550-II	29.95
TI-30	22.95	TI-5050M	99.95



## corvus

Advanced Scientific 500	\$69.95
Financial 6 Memory 600	59.95
Business 625	24.95

## HEWLETT PACKARD

(No credit cards)

HP-21	\$ 71.00	HP-27	\$175.00
HP-22	145.00	HP-67	395.00
HP-25	127.60	HP-25C	175.00

## NOVUS NATIONAL SEMICONDUCTOR

Mathematician 4510 (2 min.)	\$17.88
Scientist 4520	29.95
Scientist PR 4525	54.95
Financier 6020	26.45
Financier PR 6025	54.95
Statistician PR 6035	54.95
NS-4640	54.95

CREDIT CARD BUYERS CALL  
(800) 421-0367 (other than Calif.)  
In California call (213) 370-5795 or  
SEND CHECK OR MONEY ORDER;

IN CALIF. ADD 6% sales tax. WE SHIP UPS AIR.  
ADD \$2.50 min. shipping charge U.S. only.  
\$4.00 for SR-52, PC-100

**tk**enterprises  
BETTER BUSINESS PRODUCTS

16611 HAWTHORNE BLVD., LAWDALE, CA 90260  
(213) 370-5795

CIRCLE NO. 72 ON FREE INFORMATION CARD

**FREE**

with your  
business card  
or send \$1.00

## Giant Catalog

64 Pages of News about the  
Amazing Technological Break-  
throughs in the Mini-Micro  
Computer Field!

### Catalog includes:

- Reproductions of manufacturers complete catalogs including IMSAI's—normally \$1.00
- Articles and news on Mini-Micro Computers
- \$2.00 Gift Certificate
- Includes all this and more!

### Catalog offers items like:

- \$289 complete Computer System for home use Not a kit!
- Thorough Home Study Course on *How to Computer Program*. Includes text books and computer!
- Low cost New and Used Peripherals
- Many more items!

Send \$1.00 now (refundable on first order)  
or Free with Business Card!

Newman Computer Exchange  
3960 Varsity Drive, Dept. 19  
Ann Arbor, Michigan 48104

CIRCLE NO. 44 ON FREE INFORMATION CARD

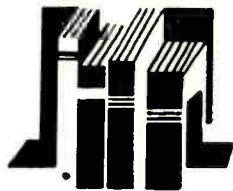

# Electronics Library

## RADIO CONTROL FOR MODELS

by R. Warring

Model planes, boats, cars, and helicopters that can be controlled by radio are examined in this book, along with the methods and systems that can be employed. Although schematic diagrams are included, the emphasis is on "black box" units that can be bought or built. Basic radio concepts and single-channel systems are covered; after which multi-channel systems are introduced. Other aspects of RC modeling, such as engines, wiring, workshop techniques, and batteries are developed.

Published by Tab Books, Blue Ridge Summit, PA 17214. 350 pages. \$6.95 soft cover, \$9.95 hard cover.

## 99 WAYS TO KNOW AND USE YOUR ELECTRONIC CALCULATOR

by Louis Frenzel, Jr.

The two principal areas covered by this book are determining your calculator needs, and how to use a "four banger" to calculate other mathematical functions. Among these are reciprocals, roots, logarithms, and trigonometric, statistical, and probability functions.

Published by Howard W. Sams & Co., 4300 W. 62nd St., Indianapolis, IN 46206. 192 pages. \$5.95 soft cover.

## TUNE IN THE WORLD WITH HAM RADIO

by the ARRL Staff

This beginner's information package consists of a guidebook, a tape cassette, and a call-section map of the United States. The three comprise a complete course in basic radio theory, FCC Rules and Regulations, and Morse code at a level that will enable the reader to pass the Novice Class license tests. The 134-page, 8 1/4" x 11" guidebook includes much of the "human interest" aspect of Amateur Radio and covers radio theory, equipment selection and the process of getting on the air after a license is received. The one-hour cassette has an introduction by media personality Jean Shepherd, K2ORS, and a course in Morse code. A full-color 22" x 34" wall map includes a checklist to measure progress toward the Worked All States Award. Published by The American Radio Relay League, 225 Main Street, Newington, CT 06111. \$7.00 (U.S. and Possessions).

## The quick charge iron with 16 different quick change tips.



**ISO-TIP®**  
QUICK CHARGE  
Cordless  
Soldering Iron  
completely  
recharges in  
3 1/2-4 hours.  
Low voltage,  
battery powered,  
ground free  
isolated tip  
design.

16 snap-in tips  
to fit any job  
plus a PC  
Drill.

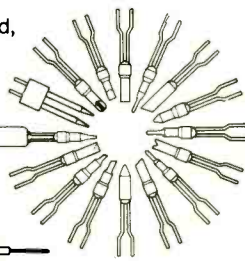

## WAHL CLIPPER CORPORATION

ORIGINATORS OF PRACTICAL CORDLESS SOLDERING

• Sterling, Illinois 61081 • (815) 625-6525

"Manufacturing Excellence Since 1919"

CIRCLE NO. 76 ON FREE INFORMATION CARD

## A Major Advance...

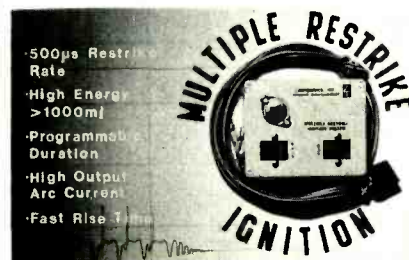

- 500ps Restrike Rate
- High Energy >1000mj
- Programmable Duration
- High Output Arc Current
- Fast Rise Time

- \*EFFICIENT ENGINE PERFORMANCE
- \*REDUCED MAINTENANCE EXPENSE
- \*1 YEAR GUARANTEE OF PRODUCTS

For those who need maximum firing potential, Labtronics offers the Multiple Restrike Ignition. The system produces a high energy repetitive spark on each power stroke which insures the greatest statistical chance for proper ignition. Dependable system triggering from breaker-points, magnetic pick-ups or the extremely accurate '13A1-xx' infrared triggering unit. Order your system and enjoy the economy and peak performance of an efficient engine.

## LABTRONICS, INCORPORATED

3835 HILLSIDE DRIVE • YPSILANTI, MICHIGAN 48197

<b>MULTIPLE RESTRIKE SYSTEM</b>		
[ ] Model VI	Programmable Duration	\$79.95
[ ] Model VI-B	Fixed Burst Duration	\$59.95
[ ] Model VI-C	Complete Optical System	\$79.95
<b>HIGH ENERGY SYSTEM (Single Strike)</b>		
[ ] Model V	Points Triggering System	\$29.95
[ ] Model V-C	Complete Optical System	\$47.95
<b>TRIGGERING UNITS</b>		
[ ] 13A1-xx	Optical Trigger Unit	\$24.95
[ ] 6129B	Magnetic Amplifier	\$ 4.95

CIRCLE NO. 39 ON FREE INFORMATION CARD  
POPULAR ELECTRONICS

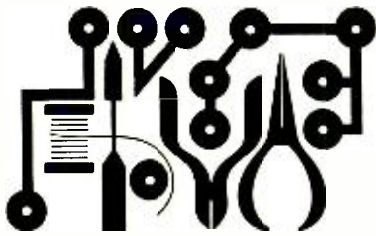

# Experimenter's Corner

By Forrest M. Mims

## HIGH-VOLTAGE DC/DC CONVERTERS

IN THIS day of low-voltage semiconductor circuits that are often battery-powered, electronics experimenters rarely use more than 10 or 15 volts for their projects. But, although vacuum-tube projects are becoming increasingly rare, there are still many requirements for high voltages in modern circuits. For example, neon lamps require 60 to 70 volts, semiconductor laser pulse power supplies require up to several hundred volts, and xenon flash tubes require several hundred discharge volts and several kilovolts of trigger potential. Other high voltage components include photomultiplier tubes, helium-neon laser tubes, and image converters.

Some of the more exotic components that require a high operating potential are far too expensive for the average hobbyist, but many HV components are readily available. Advertisers in this magazine regularly offer such goodies as neon glow lamps, laser tubes, laser diodes, Panaplex™ displays, and assorted HV capacitors, SCR's, triacs, and rectifiers.

Several different circuits can be used to generate the high voltages required by these and other components. The most common up-

converters are powered by household line current. This, of course, poses a safety problem in addition to the HV output and limits portability to the length of the power cord. For this reason miniature solid-state dc-to-dc voltage converters that operate from low-voltage batteries are very popular with both engineers and experimenters who require a high-voltage power supply.

**Dc-to-dc Converters.** Let's examine two very simple dc-to-dc converters that can be used in low-current, high-voltage applications. The first circuit, shown in Fig. 1, is ultra-simple and illustrates the miniaturization potential of a solid-state high-voltage power supply.

The circuit is a modified Hartley oscillator that uses an ordinary audio input transformer for the inductor. The low-impedance, center-tapped secondary supplies the feedback required to start and maintain oscillation. The pulses generated by the oscillator pass through the secondary winding, where they are inductively coupled into the primary. The transformer steps up the input from a few volts of steady dc to several hundred volts of rapidly pulsating current.

To give some idea of the performance of this potent circuit, here's a table of the outputs I measured for a range of input voltages:

Input (volts)	Output (volts)
0.5	1
1.0	200
2.0	440
3.0	625
4.0	800
5.0	900
6.0	1000

These potentials were measured under open-circuit conditions. When the converter is connected to an output device, the subsequent load will reduce the output voltage. Neverthe-

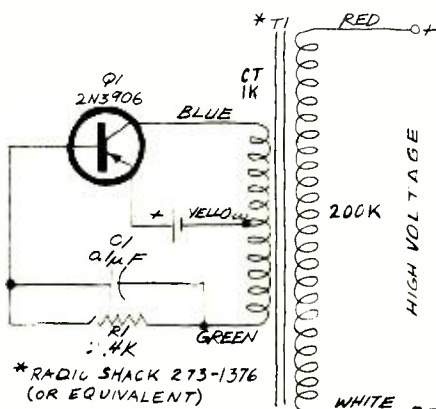

Fig. 1. Simple dc/dc converter.

## Put Professional Knowledge and a COLLEGE DEGREE in your Electronics Career through HOME STUDY



### Earn Your DEGREE

by correspondence, while continuing your present job. No commuting to class. Study at your own pace. Learn from complete and explicit lesson materials, with additional assistance from our home study instructors. Advance as fast as you wish, but take all the time you need to master each topic. Profit from, and enjoy, the advantages of independent study.

The Grantham electronics degree program begins with basics, leads first to the A.S.E.T. degree, and then continues through the B.S.E.E. degree level. Our free bulletin gives complete details of the program itself, the degrees awarded, the requirements for each degree, and how to enroll. Write or phone (no collect calls please) and ask for BULLETIN E-76.

**Grantham School of Engineering**  
2000 Stoner Ave., Los Angeles, CA 90025

• Telephone (213) 477-1901 •

Worldwide Career Training thru Home Study

CIRCLE NO. 30 ON FREE INFORMATION CARD

# SAVE!

**MONEY • TIME • FREIGHT**

- ♪ QUALITY STEREO EQUIPMENT AT LOWEST PRICES.
- ♪ YOUR REQUEST FOR QUOTATION RETURNED SAME DAY.
- ♪ FACTORY SEALED CARTONS—GUARANTEED AND INSURED.
- ♪ SAVE ON NAME BRANDS LIKE:
 

A.D.C.	KLH
A.R.	SHURE
DYNACO	KOSS
SONY	FISHER

**PIONEER**  
AND MORE THAN 50 OTHERS  
BUY THE MODERN WAY  
BY MAIL—FROM

**illinois audio**

Department 217S  
12 East Delaware  
Chicago, Illinois 60611  
312-664-0020

CIRCLE NO. 34 ON FREE INFORMATION CARD



## A Completely Portable, Polytonic Synthesizer System For Under \$140.00

CONJURE IT UP FROM:

THE GNOME MICRO-SYNTHESIZER kit no. 3740 \$48.95 + 4 lbs. shipping

— AND —

OZ-MINI-ORGAN & POLYTONIC PITCH SOURCE kit no. 3760 \$84.95 + 12 lbs. shipping

Hear them on our 24 hr. Demo-Line (405)843-7396 and get our FREE CATALOG with more

## Magical Musical kits

FROM: **RAIA** ELECTRONICS DEPT. 10 P  
1020 WEST WILSHIRE BLVD.  
OKLAHOMA CITY, OK 73116  
CIRCLE NO. 48 ON FREE INFORMATION CARD

less, the performance of the circuit is quite impressive. Incidentally, with the component values specified, the oscillator frequency ranged from 344 to 574 Hz over the range of input voltages. The pulse width was a relatively constant 150  $\mu$ s.

The current output of this circuit is minuscule, but it can easily ionize a neon lamp or power a semiconductor laser power supply. It can also operate the simple neon-lamp relaxation oscillator shown in Fig. 2. This circuit will flash about once a second with the component values shown. In operation,  $C_1$  charges through  $R_1$  until the breakdown voltage of  $I_1$  is reached. When  $I_1$  fires,  $C_1$  discharges through  $I_1$ , and the cycle repeats. Diode  $D_1$  keeps  $C_1$  from discharging back through the transformer winding.

A single 1.5-volt cell will provide enough power when using the dc-to-dc converter to operate neon lamps. Since a neon lamp requires 60 to 70 volts for operation, this provides an impressive demonstration of the circuit's high-voltage capability.

The current drain of the Fig. 1 circuit connected to the neon flasher in Fig. 2 is fairly low. The circuit draws 12.3 mA from a fresh D cell at 1.5 volts, 8.3 mA from a fully charged 1.2-volt nickel-cadmium cell, and only 6.8 mA from a 1-volt source.

The simple circuit in Fig. 1 is typical of most dc-to-dc converters in that the transformer plays an active role in both the oscillator and HV sections of the circuit. Dc-to-dc converters can also be designed so that the transformer functions strictly as a voltage converter. One possibility is shown in Fig. 3, where a unijunction transistor oscillator is connected to a high-turns-ratio input transformer like the one used in Fig. 1. The oscillator produces a series of fast risetime pulses each time  $C_1$  discharges through the emitter-to-B1 junction of  $Q_1$ . The pulses are passed through the low-impedance winding of the transformer

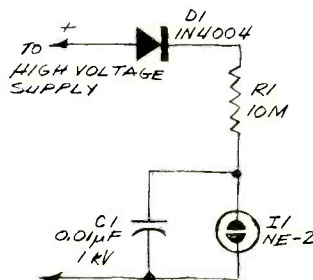

Fig. 2. Neon relaxation oscillator.

★ **FREE!** ★



## NEW CATALOG OF HARD-TO-FIND PRECISION TOOLS

Jensen's new 128-page catalog is jam-packed with more than 2800 quality items. Your single source for hard-to-find precision tools used by electronic technicians, scientists, engineers, instrument mechanics, schools, laboratories and government agencies. This wanted catalog also contains Jensen's world-famous line of more than 40 tool kits. Plus 10 pages of useful "Tool Tips" to aid in tool selection. Send for your free copy today!



JENSEN TOOLS and ALLOYS  
4117 N. 44th Street, Phoenix, Arizona 85018

A BLISS & LAUGHLIN industry

CIRCLE NO. 38 ON FREE INFORMATION CARD

## SAVE ON Brand Name Audio Components

BY MAIL

### Write Today for Our FREE Audio Catalog

DIXIE is one of the oldest and largest audio component mail order houses in the country. Our prices on brand name components are actually LOWER than "Discounters". See our new catalog or call us for a price quote. Everything shipped factory-sealed with full manufacturer's warranty.

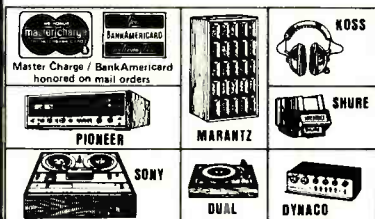

### DIXIE HI-FIDELITY

PE-10

5600 Second St., N. E., Washington, D. C. 20011  
Phone: 1-202-635-4900

Please rush me your FREE Audio Catalog and complete information. I understand there is no obligation.

Name \_\_\_\_\_  
Address \_\_\_\_\_  
City \_\_\_\_\_  
State \_\_\_\_\_ Zip \_\_\_\_\_

## THE VOLKSMETER + NEW!! LM-3.5

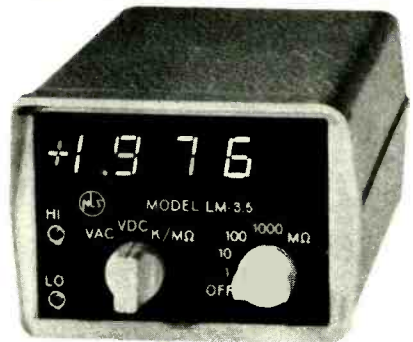

With Rechargeable Batteries & Charger Unit.

**\$147**

### Features Include:

- 3-1/2 digits - the LM-3 plus 100% over-range.
- 19 ranges: 4 vdc, 4 vac, 3 dc amps, 3 ac amps and 5 ohms. • Automatic polarity with 1% accuracy. • Fully protected input. • Small size: 1.9" H x 2.7" W x 3.9" D.

Also - a 1%, 3-digit LM-3 @ \$125, a 0.1%, 4-digit LM-40 @ \$190 and a 0.05%, 4-digit LM-4 @ \$227.

See your local distributor!

Distributor inquiries invited.



### Non-Linear Systems, Inc.

Originator of the digital voltmeter.

Box N, Del Mar, California 92014

Telephone (714) 755-1134 TWX 910-322-1132

CIRCLE NO. 45 ON FREE INFORMATION CARD

POPULAR ELECTRONICS

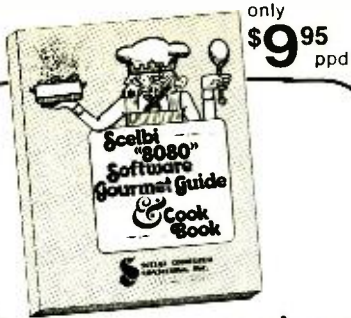

only  
**\$9.95**  
ppd

## Now you can cook-up hot programs on your "8080"

A gourmet's delight of practical "how to" facts, including description of "8080" instruction set. How to manipulate "8080" stack. Flow charts. Source listings. Routines for multiple precision operation. Programming time delays for real time applications. Random number generators. Completely assembled floating point math program. Input/output processing for basic I/O programming through interrupt processing. Code, numeric conversion routines. Real time programming. Search/sort routines. Plus many more finger-lickin' goodies.

Order your copy of Scelbi's "8080" Software Gourmet Guide & Cook Book today! Only \$9.95 ppd. Bon appetite!



**SCELBI COMPUTER CONSULTING INC.**

1322 Rear Boston Post Road  
Milford, CT 06460 • (203) 874-1573  
CIRCLE NO. 60 ON FREE INFORMATION CARD

## Popular Electronics 1975 ANNUAL INDEX

Hundreds of references to subjects, products, equipment, and technical tips that you know are in the magazine but can never find when you want them—all arranged for fast easy reference.

Prepared in cooperation with the magazine editors, each of these handy indexes covers a full year (12 issues) and is an indispensable companion to your magazine collection.

**\$1.50** per copy plus \$.25 per order for postage and handling.

1972, 73 and 74 indexes also still available at \$1.50 each or \$5.50 for the complete set of four (1972 thru 1975).

POPULAR ELECTRONICS INDEX  
Box 2228, Falls Church, Va., 22042

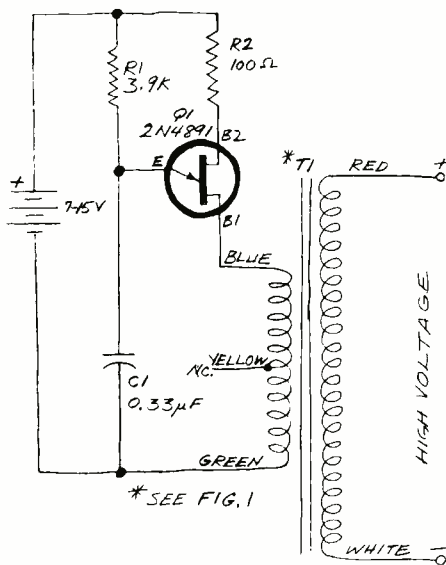

Fig. 3. UJT delay converter.

and induced into the high-impedance winding as high voltage pulses.

Due to the presence of the unijunction transistor, the circuit in Fig. 3 requires a higher operating voltage (7 to 15 volts) than the circuit in Fig. 1. But at 10 volts the circuit will operate the neon flasher in Fig. 2 with a current drain of only 0.5 mA. This corresponds to a total power consumption of about 5 mW versus about 18 mW for the previous circuit.

**Conclusion.** The two simple dc-to-dc converters described in this column are adequate for powering neon lamps, diode-laser pulse generators, and other low-current devices. If you have access to an oscilloscope, you can watch the output voltages while tinkering with the values of  $R1$  and  $C1$  in both circuits to optimize the operating conditions. More powerful converters are required for many HV applications, and a subsequent column will continue this interesting subject with a couple of additional dc-to-dc converters.

Meanwhile, try experimenting with the circuits described here to get experience. Finally, always use care when experimenting with any high-voltage circuit. Small size and low battery voltage mean little when high voltage is present! A low-current shock may not harm you, but the resulting reflex jerk may injure a hand, arm, or elbow and knock items from your workbench. A high-current shock, such as from a charged capacitor, can be fatal. ♦



**save on gas!  
save on tune-ups!  
save on maintenance!**

Electronic ignition is "IN"! So says Detroit.

Update your car with either a TIGER CD or a TIGER I breakerless system.

Enjoy the benefits of better gas mileage, quicker starting, elimination of tune-ups, 50,000 miles on points and plugs, and reduced maintenance expenses.

TIGER MAX CD	\$69.95
TIGER 500 CD	59.95
TIGER SST CD	42.95
SIMPLIKIT CD	31.95
TIGER I	45.95

Postpaid U.S.A. only.

**Tri-Star Corporation**

Dept. ZZ, P.O. Box 1727  
Grand Junction, Colorado 81501  
CIRCLE NO. 74 ON FREE INFORMATION CARD



**DON'T LET  
OUR NAME  
FOOL  
YOU**

**STEREO DISCOUNTERS**

WE'RE ALSO  
**CB DISCOUNTERS!**

Save by buying from a high volume dealer.  
Send for your Free Hi-Fi and CB Catalog ...  
Or call for a price quote on our "Super Service" line ...

**301-252-6880**

-----  
Name \_\_\_\_\_  
Address \_\_\_\_\_  
City \_\_\_\_\_ State \_\_\_\_\_ Zip \_\_\_\_\_  
**STEREO DISCOUNTERS**  
7A Aylesbury Rd.  
Timonium, Md. 21093

PE-10

CIRCLE NO. 71 ON FREE INFORMATION CARD

# ELECTRONICS MARKET PLACE

**NON-DISPLAY CLASSIFIED: COMMERCIAL RATE:** For firms or individuals offering commercial products or services, \$2.25 per word (including name and address). Minimum order \$33.75. Payment must accompany copy except when ads are placed by accredited advertising agencies. Frequency discount; 5% for 6 months; 10% for 12 months paid in advance. **READER RATE:** For individuals with a personal item to buy or sell, \$1.35 per word (including name and address.) No minimum! Payment must accompany copy. **DISPLAY CLASSIFIED:** 1" by 1 column (2-1/4" wide), \$260.00. 2" by 1 column, \$520.00. 3" by 1 column, \$780.00. Advertiser to supply film positives. For frequency rates, please inquire.

**GENERAL INFORMATION:** First word in all ads set in caps at no extra charge. All copy subject to publisher's approval. All advertisers using Post Office Boxes in their addresses **MUST** supply publisher with permanent address and telephone number before ad can be run. Advertisements will not be published which advertise or promote the use of devices for the surreptitious interception of communications. Ads are not acknowledged. They will appear in first issue to go to press after closing date. Closing Date: 1st of the 2nd month preceding cover date (for example, March issue closes January 1st. Send order and remittance to **POPULAR ELECTRONICS**, One Park Avenue, New York, New York 10016, Attention: Hal Cymes.

## FOR SALE

FREE! Bargain Catalog—I.C.'s, LED's, readouts, fiber optics, calculators parts & kits, semiconductors, parts. Poly Paks, Box 942PE, Lynnfield, Mass. 01940.

GOVERNMENT Surplus Receivers, Transmitters, Sniperscopes, Radios, Parts, Picture Catalog 25 cents. Meshna, Nahant, Mass. 01908.

LOWEST Prices Electronic Parts. Confidential Catalog Free. KNAPP, 3174 8th Ave. S.W., Largo, Fla. 33540.

ELECTRONIC PARTS, semiconductors, kits, FREE FLYER. Large catalog \$1.00 deposit. BIGELOW ELECTRONICS, Bluffton, Ohio 45817.

RADIO—T.V. Tubes—36 cents each. Send for free catalog. Cornell, 4213 University, San Diego, Calif. 92105.

AMATEUR SCIENTISTS, Electronics Experimenters, Science Fair Students... Construction plans—Complete, including drawings, schematics, parts list with prices and sources... Robot Man — Psychedelic shows — Lasers — Emotion/Lie Detector — Touch Tone Dial — Quadraphonic Adapter — Transistorized Ignition — Burglar Alarm — Sound Meter... over 60 items. Send 50 cents coin (no stamps) for complete catalog. Technical Writers Group, Box 5994, University Station, Raleigh, N.C. 27607.

METERS—Surplus, new, used, panel or portable. Send for list. Hanchett, Box 5577, Riverside, CA 92507.

MECHANICAL, ELECTRONIC devices catalog 10 cents. Greatest Values — Lowest Prices. Fertik's, 5249 "D", Philadelphia, Pa. 19120.

SOUND SYNTHESIZER KITS—Surf \$12.95, Wind \$12.95, Wind Chimes \$17.95, Electronic Songbird \$6.95, Musical Accessories, many more. Catalog free. PAIA Electronics, Box J14359, Oklahoma City, OK 73114.

BUGGED??? New locator finds them fast. Write, Clifton, 11500-L N.W. 7th Avenue, Miami, Florida 33168.

**DISCOUNT PRICES**  
**B&K, SENCORE, LEADER, RCA**  
**EICO, FLUKE, HICKOK, SIMPSON**  
**Test Equipment**  
 ICC/ServiceMASTER, RCA and Raytheon Tubes  
 Complete line of electronic supplies  
 Free Catalog  
**FORDHAM RADIO SUPPLY CO., INC.**  
 855R Conklin St., Farmingdale, N.Y. 11735 (516) 752-0050

YOU WILL SAVE BIG MONEY! Surplus, Clearouts, Bankruptcy, Inventory, Deals. Catalog \$1 (redeemable). ETCOA Electronics, Box 741, Montreal, H3C 2V2. U.S. Inquiries.

HEAR POLICE/FIRE Dispatchers! Catalog shows exclusive directories of "confidential" channels, scanners. Send postage stamp. Communications, Box 56-PE, Commack, N.Y. 11725.

SURPRISE! Build inexpensively, the most Unusual Test Instruments, Futuristic Gadgets using Numerical Readouts! Catalogue Free! GBS, Box 100A, Green Bank, West Virginia 24944.

TELEPHONES UNLIMITED, equipment, supplies. Catalog 50 cents. Box 1654E, Costa Mesa, Calif. 92626.

UNSCRAMBLERS: Fits any scanner or monitor, easily adjusts to all scrambled frequencies. Only 4" square \$29.95, fully guaranteed. Dealer inquiries welcomed. PDD Electronics, Box 841, North Little Rock, Arkansas 72115.

SURPRISE! SURPRISE! Digital Piano Tuning Device tunes musical instruments Accurately! Perfectly! Inexpensively! Construction-Instruction-Plans Complete \$12.95 Airmailed Postpaid! Moonlighting quickly repays \$40 electronics investment! GBS, Box 100P, Green Bank, West Virginia 24944.

RECONDITIONED Test Equipment. \$0.50 for catalog Walter's Test Equipment, 2697 Nickel, San Pablo, CA 94806.

**Send for your information packet today—**

which also includes circuit functions, component line-up, and accessories. Information Packet \$1.00 (refundable with order).

**visulex** P. O. Box 4204P Mountain View, CA 94040

POLICE, Fire monitors, scanners, crystals, CB Transceivers, New Crystal-less scanners. Discount priced. Box 19224, Denver, CO 80219.

TELETYPE EQUIPMENT for sale for beginners and experienced computer enthusiast. Teletype machines, parts, supplies. Catalogue \$1.00 to: ATLANTIC SALES, 3730 Nautilus Ave., Brooklyn, NY 11224. Tel: (212) 372-0349.



## WORLD'S SMALLEST ELECTRONIC RECHARGEABLE CALCULATOR... \$1995 Ppd.

**WITH A MEMORY!**  
*Does Everything Big Ones Do*

**SCIENTIFIC VERSION** — Same as above, plus twelve scientific functions: sine, cosine, tangent; and inverse of each; square root; natural logarithm, e<sup>x</sup>; pi. 1X. scientific notation; exponential; plus error and automatic overflow and underflow.

Built-in recharger pack, 1 7/8 x 1 1/8 x 3/16"

Small but mighty! 8-digit, 4-function electronic calculator even has automatic % key... for only \$19.95. Take it anywhere. Carry it in your pocket or purse—it's 2/3 the size of a pack of cigarettes. This 3 1/2-ounce dynamo features floating decimal, constant key, lead zero depression, clear entry, more! At Edmund's low price, the unit comes with a built-in Ni-Cad rechargeable battery pack that can plug into any AC outlet. No need for special recharging adapters. Calculator overall is just 2 x 3 1/2 x 9/16" with plenty of room for most fingers. **Another Edmund first with advanced technology.** Stock No. 1995AV... Only \$19.95 Ppd.

Stock No. 1950AV  
Only \$24.95 Ppd.

## GIANT FREE CATALOG!

NEW 164 Pages  
Over 4,500 Un-usual Bargains for Hobbyists, Schools Industry



JUST CHECK COUPON!

**EDMUND SCIENTIFIC CO.**  
300 EDSCORP BUILDING  
Barrington, N. J. 08007  
(609) 547-3488

America's Greatest  
Science • Optics • Hobby Mart

## COMPLETE AND MAIL COUPON NOW

EDMUND SCIENTIFIC CO. 300 Edscorp Bldg., Barrington, N. J. 08007

Send Me:

ELECTRONIC CALCULATOR(S)  
#1995AV @ \$19.95 ea \$ \_\_\_\_\_

SCIENTIFIC CALCULATOR(S)  
#1950AV @ \$24.95 ea \$ \_\_\_\_\_

SPARE RECHARGER PACK(S)  
#30.763AV @ \$4.95 ea \$ \_\_\_\_\_

Service and handling charge \$ 1.00

Enclosed is  
 check,  m.o. in amount of \$ \_\_\_\_\_

Interbank No. \_\_\_\_\_

Card No. \_\_\_\_\_

Expiration Date \_\_\_\_\_

30-DAY MONEY-BACK GUARANTEE. You must be satisfied or return any purchase in 30 days for full refund.

City \_\_\_\_\_ State \_\_\_\_\_ Zip \_\_\_\_\_

## PLANNING TO MOVE?

Let us know 8 weeks in advance so that you won't miss a single issue of **POPULAR ELECTRONICS**.

Attach old label where indicated and print new address in space provided. Also include your mailing label whenever you write concerning your subscription. It helps us serve you promptly.

Write to: P.O. Box 2774, Boulder, CO 80302, giving the following information:

- Change address only     Extend my subscription
- ENTER NEW SUBSCRIPTION**
- 1 year \$9.98     Payment enclosed  
Allow 30-60 days for delivery.    (1 extra BONUS issue)
- Bill me later

NEW ADDRESS HERE

0189

Name \_\_\_\_\_ please print

Address \_\_\_\_\_

City \_\_\_\_\_

State \_\_\_\_\_ Zip \_\_\_\_\_

Additional postage per year: For Canada add \$3 For countries outside U.S. and Canada, add \$5—cash in U.S. currency only

AFFIX OLD LABEL

If you have no label handy, print OLD address here.

Name \_\_\_\_\_ please print

Address \_\_\_\_\_

City \_\_\_\_\_

State \_\_\_\_\_ Zip \_\_\_\_\_

# S. D. SALES CO.

P. O. BOX 28810 - D  
DALLAS, TEXAS 75228

## 4K LOW POWER RAM BOARD KIT

THE WHOLE WORKS

Imsai and Altair 8080 plug in compatible. Uses low power static 21L02-1 500 ns. RAM's, which are included. Fully buffered, drastically reduced power consumption, on board regulated, all sockets and parts included. Premium quality plated thru PC Board.

# \$89.95

8 Digit LED  
"METRIC MASTER"  
**\$19.95**

"RAPID MAN - 12"  
**\$29.95**

**\$1,000,000 CALCULATOR PURCHASE!**  
We bought the entire stock of a major manufacturer. New, guaranteed units.  
Five functions PLUS complete Metric Conversion functions. Rechargeable batteries. Small, hand held size. With AC charger.  
12 Digit - Desk Top Style. Sturdy design. With memory and four complete functions. Big, bright display.

### ALARM CLOCK KIT SIX DIGIT LED

Thousands of hobbyists have bought and built our original clock kit and were completely satisfied. But we have received many requests for an alarm clock kit with the same value and quality that you have come to expect from S. D. So, here it is! THE KIT INCLUDES:

- 1 Mostek 50252 Alarm Clock Chip
- 6 Hewlett Packard .30 in. common cathode readouts
- 15 NPN Driver Transistors
- 2 Switches for time set
- 2 Slide Switches for alarm set and enable
- 1 Filter Cap
- 1 IN4002 Rectifiers
- 1 IN914 Diode
- 1 .01 Disc Cap
- 15 Resistors
- 1 Speaker for alarm
- 1 LED lamp for PM indicator

**\$9.95**

PCB - \$3.00  
XFMR - \$1.50

### MOTOROLA RTL IC'S

Brand new, factory prime. Hard to find, but still used in a variety of projects. (See the RTL Cookbook by Howard W. Sams.)

- |              |              |               |
|--------------|--------------|---------------|
| MC724P - 59c | MC780P - 89c | MC791P - 69c  |
| MC725P - 59c | MC785P - 49c | MC792P - 59c  |
| MC764P - 49c | MC787P - 89c | MC799P - 59c  |
| MC767P - 69c | MC788P - 49c | MC970P - 89c  |
| MC771P - 49c | MC789P - 59c | MC9709P - 69c |
| MC775P - 89c | MC790P - 89c | MC9760P - 69c |

### 60 HZ CRYSTAL TIME BASE - \$5.95

KIT FEATURES:  
A. 60 hz output with accuracy comparable to a digital watch  
B. Directly interfaces with all MOS Clock chips  
C. Super low power consumption (1.5 Ma typ.)  
D. Uses latest MOS 17 stage divider IC  
E. Eliminates forever the problem of AC line glitches  
F. Perfect for cars, boats, campers, or even for portable clocks at ham field days. BUY TWO FOR \$10.00!  
G. Small size, can be used in existing enclosures.  
KIT INCLUDES CRYSTAL DIVIDER IC, PC BOARD PLUS ALL OTHER NECESSARY PARTS AND SPECS.

### TTL INTEGRATED CIRCUITS

7400 - 19c	7430 - 19c	7476 - 35c	74153 - 75c
7402 - 19c	7432 - 34c	7480 - 49c	74154 - 1.00
74L04 - 29c	7437 - 39c	7483 - 95c	74157 - 75c
74S04 - 44c	7438 - 39c	7485 - 95c	74161 - 95c
7404 - 19c	7440 - 19c	7586 - 45c	74164 - 1.10
7406 - 29c	7447 - 85c	7490 - 65c	74165 - 1.10
7408 - 19c	7448 - 85c	7492 - 75c	74174 - 95c
7410 - 19c	7451 - 19c	7495 - 75c	74181 - 2.50
7411 - 29c	7453 - 19c	7496 - 89c	74191 - 1.25
7413 - 50c	7473 - 39c	74121 - 38c	74192 - 1.25
7420 - 19c	7474 - 35c	74123 - 65c	74193 - 1.00
	7575 - 35c	74141 - 75c	74195 - 69c

### "CUBO" - DIGITAL ALARM CLOCK CUBE



A PERFECT GIFT - NOT A KIT!  
The CUBO Alarm Clock mfg. by Corvus, division of MOSTEK CORP. Originally sold for \$49.95. We bought out their entire inventory. All new, individually gift boxed. Mini size (2 1/2" cube) with maxi performance.

- FEATURES:  
A. 4 Digit H.P. Bright Display  
B. "Second Hand" LED Activity Indicator  
C. 24 Hour Alarm; 12 hour real time format  
D. 10 Minute Snooze  
E. Auto Display Dimming - Adjusts to Ambient Light  
F. AM/PM Indicator  
G. Power Failure Indicator  
Uses Famous Mostek MK50250 MOS LSI IC

**\$14.95 EACH**  
(Add 75c P.&H.)



**1000 MFD FILTER CAPS**  
Rated 35 WVDC. Upright style with P. C. leads. Most popular value for hobbyists. Compare at up to \$1.19 each from franchise type electronic parts stores.  
**S.D. SPECIAL 4 for \$1.**

### SLIDE SWITCH ASSORTMENT

Our best seller. Includes miniature and standard sizes, single and multi-position units. All new, first quality, name brand. Try one package and you'll re-order more. **SPECIAL - 12/\$1.**



### MOTOROLA POWER DARLINGTON

Back in Stock!  
Like MJ3001. NPN 80V. 10A. HFE 6000 TYP. TO-3 case. We include a free 723 C volt reg. with schematic for power supply.  
**SPECIAL - \$1.99**

### WESTERN DIGITAL UART

No. TR1602B. 40 pin DIP.  
This is a very powerful and popular part.  
**NEW - \$6.95 with data LIMITED QUANTITY**

### FAIRCHILD BIG LED READOUTS

A big .50 inch easy to read character. Now available in either common anode or common cathode. Take your pick. Super low current drain, only 5 MA per segment typical.  
**YOUR CHOICE: 6 for \$7.50**

- FND - 510 Common Anode \$1.50 ea.  
FND - 503 Common Cathode \$1.50 ea.

### INTEL 1702A 2K ERASEABLE PROM'S

**\$6.95**  
We tell it like it is. We could have said these were factory new, but here is the straight scoop. We bought a load of new computer gear that contained a quantity of 1702A's in sockets. We carefully removed the parts verified their quality, and are offering them on one heck of a deal. First come, first served. Satisfaction guaranteed.  
**BACK IN STOCK!**

### RESISTOR ASSORTMENT

1/4 W 5% and 10%. PC leads.  
A good mix of values. **200/\$2.**



### 74S200

256 Bit High Speed RAM  
Same as 82S16  
**\$3.95**

### 1K PROM BACK IN STOCK!

82S129. 256X4. Bipolar. 50 NS.  
FAST. WITH SPECS.  
**\$3.95**

### 8T97B

Hex Tri-State Buffer. Back in stock.  
**\$1.25**

### UP YOUR COMPUTER!

**21L02-1 1K LOW POWER 500 NS STATIC RAM**  
TIME IS OF THE ESSENCE  
And so is power. Not only are our RAM's faster than a speeding bullet but they are now very low power. We are pleased to offer prime new 21L02-1 low power and super fast RAM's. Allows you to STRETCH your power supply farther and at the same time keep the wait light off.  
**8 FOR \$17.50**

### CALL YOUR BANK AMERICARD OR MASTER CHARGE ORDER IN ON OUR CONTINENTAL UNITED STATES TOLL FREE WATTS:

**1-800-527-3460**

Texas Residents Call Collect  
**214/271-0022**

### SALE ON CUT LEAD SEMICONDUCTORS

- Leads were cut for PCB insertion. Still very useable. All new, unused. Some House no.
- 1N914/1N4148 . . . . . 100/\$2.
  - 1N4002 1 Amp 100 P;V . . . . . 40/\$1.
  - 1N4745A 16V 1W Zener . . . . . 20/\$1.
  - EN2222 NPN Transistor . . . . . 25/\$1.
  - EN2907 PNP Transistor . . . . . 25/\$1.
  - 2N3904 NPN Driver Xstr . . . . . 25/\$1.
  - 2N3392 GE Pre-amp Xstr . . . . . 25/\$1.
  - C103Y SCR. 800MA 60V . . . . . 10/\$1.

### C&K MINI TOGGLE SWITCH

No. 7103 SUB MINI SPDT Center OFF.  
**SPECIAL - 99c**

### TERMS:

Money Back Guarantee. No COD. Texas Residents add 5% tax. Add 5% of order for postage and handling. Orders under \$10. add 75c. Foreign orders: US Funds ONLY!

### S. D. SALES

P. O. Box 28810 - D  
Dallas, Texas 75228

ORDERS OVER \$15. CHOOSE \$1. FREE MERCHANDISE





# THE KING OF ALTAJ 25.50



## 6-DIGIT ALARM CLOCK

THE KING FEATURES:

- 1) 6 digit, 12 hr. 60 cycle or 24 hr. 50 cycle alarm clock
- 2) Time sharing capability for display of additional information
- 3) Single 12v supply and a minimum of interface components
- 4) AM-PM and automatic power fail warning indicators
- 5) 10 minute snooze
- 6) Intensity control of LEDs

Kit No. 70250-1R (red readouts) Add 10% for Shipping  
 Kit No. 70250-1G (Green readouts)  
 Kit No. 70250-1Y (Yellow readouts)  
 Kit No. 70250-2R (DL727 readouts) 5 in. \$29.50  
 Kit No. 70250-3R (FND807 readouts) 8 in. \$34.50

All kits include components, PC Boards, Transformer, case, and construction manual

# THE KING'S HAREM

## FATIMA 4-DIGIT TEMP. KIT \$24.95



Features 4-digit temperature display, Fahrenheit or Centigrade, complete CMOS application, uses 7002 4 digit counter.

Kit includes all components, PC Board and instructions for interfacing with THE KING 6 digit alarm clock. Addtional Number 1

## DELILA APPLIANCE STARTER \$9.95

(Example) Set your alarm for 7 a.m., set timer for 15 min. At exactly 7 a.m., the appliance will start at 7:15 your clock alarm will wake you.

Kit includes all components, PC Board and instructions for interfacing with THE KING 6 digit alarm clock. Addtional Number 2

## TANYA 60 HZ CRYSTAL TIME BASE \$5.95

ADDITIONAL FEATURES:

- 1) Low Power Consumption
- 2) Directly Interfaces with King MOS Clock Chip
- 3) 60 Hz output with crystal time base accuracy
- 4) Ideal for Cars, Boats, & Campers

Kit includes all components, PC Board and instructions for interfacing with THE KING 6-Digit Alarm Clock. Addtional Number 3.



**FND 70**  
RED, 25 In. Char.  
15mA per segment.  
Common Cathode  
\$1.25

**DL727**  
One of our best readouts  
5 in. high, 20mA per  
segment. Common anode.  
\$3.75



**FND 503**  
New 5 in. display  
by Fairchild.  
Common Cathode  
\$1.60  
\$1.57/50

**FND 807 ANODE  
FND 800 CATHODE**  
Kin. High. The Best  
on the market. Ideal  
for large readout  
application. \$4.95



**BURROUGHS  
12 DIGIT**  
25 in. high orange  
digit. 150mA dc.  
Free socket. \$2.50



**T1**  
Fully multiplexed common cathode.  
Goldplated. Ideal for min 6 digit  
clock. \$1.30

**LEDS**  
Mini red 12  
Jumbo red 15  
Jumbo green 20  
Jumbo yellow 25



**DL33** If you have  
array of displays,  
we have it. Com-  
mon cathode. \$1.45

## TTL BOARDS

MEMORY computer boards with TTL's Diodes and Transistors, etc.  
5 Boards containing 150-250 IC's \$4.50

**GE TRANSISTOR ASSORTMENT**  
T098 cased Darling, SCRs  
NPN, PNP, etc. \$5.00 for \$1.50  
100 for \$2.50  
300 for \$6.00

## LSI INTEGRATION

MMS316	4 8 digit alarm clock 40 pin dip w/spec.	\$ 4.25
7002	4 digit counter/latch decoder, 7 segment and BCD outputs, 28 pin dip w/spec.	\$12.50
7005	4 digit counter/latch decoder, 7 segment output only, 24 pin dip w/spec.	\$ 9.50
7007	4 digit counter/latch decoder with BCD output only, 16 pin dip w/spec.	\$ 7.00
7408	4 8 digit alarm clock, 28 pin dip w/spec.	\$ 5.50
70250	PC Board for 70250.	\$ 4.25
70380	4 digit non multiplexed radio alarm clock featuring direct drive display output 40 pin dip w/spec.	\$4.50
PC Board for 70380		\$ 3.75
8006	8 bit parallel CPU	\$19.50
2102	1K static RAM for 8006	\$ 2.25
MMS703	2K UV erasable PROM	\$12.25
75491	segment driver	\$ 0.35
75492	digit driver	\$ 0.45
7020	6 function calculator chip with direct segment drive, 8 digit	\$ 2.25

## TTL

## CMOS

7400	21	7448	94	74151	80	4000	24	4018	149	4037	450
7402	21	7453	21	74153	94	4001	24	4019	59	4040	159
7404	21	7473	42	74154	100	4002	24	4020	159	4041	89
7406	29	7474	42	74161	104	4006	149	4021	149	4042	79
7408	21	7475	70	74163	124	4007	24	4022	119	4043	80
7410	21	7476	44	74164	134	4008	115	4023	24	4044	59
7413	54	7483	90	74165	154	4009	59	4024	99	4045	59
7420	21	7489	250	74174	134	4010	55	4025	24	4046	59
7427	29	7490	74	74175	144	4011	24	4026	59	4050	59
7430	21	7492	80	74182	130	4012	24	4027	99	4066	99
7437	44	7495	80	74185	154	4013	59	4028	99	4069	29
7438	39	7493	80	74193	130	4014	149	4030	49	74C12	29
7440	21	7496	80	74195	84	4015	119	4034	325	74C17	129
7442	74	7497	80	4016	59	4016	59				
7447	94	74121	43	4017	129	4035	139				
7447	94	74123	80								

## 4 & 6 DIGIT PC BOARDS

PC Board for 4 digit display FND 800 or 807	\$2.75
PC Board for 6 digit display FND 800 or 807	\$3.50
PC Board for 4 digit display MAX series or DL707	\$1.75
PC Board for 6 digit display MAX series or DL707	\$2.25
PC Board for 4 digit display FND503	\$2.00
PC Board for 6 digit display FND503	\$2.50
PC Board for 4 digit display DL747	\$2.50
PC Board for 6 digit display DL747	\$3.00
PC Board for 4 digit display DL727	\$2.25
PC Board for 6 digit display DL727	\$2.75
PC Board for 4 digit display FND70	\$1.80
PC Board for 6 digit display FND70	\$2.15



**ALTAJ ELECTRONICS**  
P.O. BOX 38544 Dallas, Texas 75238  
TERMS: Check or money order. No COD.  
Telephone (214) 278-3661  
Texas Residents Add 5%

Call Your Bank Americard or Master Charge Order in on our Continental United States Toll Free Watts: 1-800-627-4553.

\*Watts Line for Placing Orders Only!

# MSI

Wise move



# MODULAR SCIENTIFIC INSTRUMENTATION

Now you can build some of the most advanced digital electronic instruments with our new series of low-cost modular scientific kits. These kits will expand the range of your electronic applications enormously-and all at a surprisingly low cost!

The heart of the system is our 4-digit Decade Counter (Kit 012) which features a full 4-digit LED readout (you choose the size best suited to your application). Combine this with a 5 volt regulated power supply (Kit 030) and you have the basis of a wide range of sophisticated electronic instruments, including:

- A Digital Voltmeter (DVM) Kit 012 + Kit 030 + Kit 017
- Frequency Counter..... Kit 012 + Kit 030 + Kit 018 + Time Base
- RPM Counter..... Kit 012 + Kit 030 + Kit 020 + Kit 018



## 4-DIGIT DECADE COUNTER KIT \$19.95 KIT 012

One chip 4 digit decade counter kit, with both 7 segment and BCD output.

1. Chip features internal oscillator for scanning speed
2. Overflow and count extend out puts
3. Transfer, reset, count, blanking and true complement control in puts
4. PC Board can be cascaded to 8-12 16, etc. digits
5. Kit includes counter chip, drive circuit for 4 cathode type displays and PC Board. (For read out board see FND70 FND503)

## KIT 018 FREQ. COUNTER

Features FET input front end with trigger circuit for measuring complex waveforms. Measures from 0.1Hz to 10MHz when used with Kit 015 or 019. Measures from 0.1Hz to 35MHz when used with Kit 013 and 014. \$24.50



## KIT 030 POWER SUPPLY

\*Input voltage 25V max. \*Output current: 1 amp max. \*Load regulation 50mV. \*Output voltage 5V. Line regulation .01% (requires B-20V transformer) \$4.55 (Contains all parts except transformer)



## KIT 017 DVM

1.999V as basic, with polarity indication. 1 M ohm input impedance and accuracy to 1% if properly adjusted. \$16.50



## TIME BASES

1 MHz crystal chain time base divider. Outputs: 1MHz, 100kHz, 10kHz, 1kHz, 100Hz, 10Hz, 1Hz, 0.1Hz. Accuracy better than .005% with proper adjustment.

Kit 013 complete CMOS with PC Board..... \$15.75

Buffer Circuit for TTL Interfacing

Kit 014 Same as Kit 013, but with TTL..... \$13.75

Kit 015 50Hz or 60Hz chain time base using line frequency as reference. Accuracy 0.1 to 0.5%. Outputs 10Hz-1Hz-0.1Hz. Complete with CMOS shaping circuit and PC Board..... \$9.75

Kit 019 Same as Kit 015, but with TTL and 60Hz only..... \$7.75

Kit 018 60Hz chain time base using line frequency for Kit 020 RPM counter.

\*Outputs: 5 sec. = 100th of RPM  
6 sec. = 10th of RPM  
60 sec. = full resolution \$9.75



## KIT 020 RPM COUNTER

Counts from 1 to 100,000 RPM. RPM counter kit contains components and PC board. \$8.95

# MSI CLUB

Send for your membership card to the Modular Scientific Instrumentation Club and receive a big 10% off on future purchases of M.S.I. kits. Send \$3.00 with your name and address. We will promptly send you your own registered membership card. Don't miss out on the savings. Write now.

Memberships valid for one year from date of registration

## A.C.E 208 Part No. 923332

\$28.95 Add 10% for Shipping

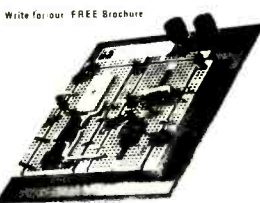

Write for our FREE Brochure

## MUSIC 60 WATT COLOR ORGAN

Completely self contained unit with 120 volt power cord included. \$2.00

## SAVE! 4-DIGIT ALARM CLOCK

\$55 SAVE! \$13.95 (with PC Board)

### FEATURES:

Direct drive display outputs. \* Current control regulation on chip. \* Low power brightness control on chip. \* RF eliminating slow wave circuitry. Sleep Radio feature. \* 24 hr. snooze alarm. \* Independent digit setting. \* Non multiplexed output circuitry. 12VAC CT 1/2 amp transformer for Kit No. 1 \$2.00

### \*KIT NO. 2

Complete kit with components PC Board, Transformer, wood grain case and filter for display window. Includes 25 in. readouts. \$21.50

### KIT NO. 3

Complete kit with components, PC Board, Transformer, wood grain case, and filter for display window. Includes 5 inch read out. \$22.50

\* Components for Kit No. 2 or Kit No. 3 sleep radio feature, and \$95



### LINEARS

555 Timer Mini dia	0.65
8038 Functional generator	4.25
RCA 3043 FM 11. Aud Preamp.	1.20
565 Phase Lock Loop	1.95
567V Tone Decoder	1.50
LM723 Pos Volt. Reg.	0.55
LM309 5V 1 amp Reg.	1.10
LM380 2w. Audio Amp 8 pin dip	1.00
LM741 Operational Amp.	0.25



### TRANSISTORS-DIODES

RCA200U 115W T05 NPN	1.25
GE D40C1 NPN Darl.	0.25
2N4443SCR 400mA T0220	0.65
2N2222 NPN Gen Amp.	0.20
2N3904 NPN Driver	0.15
2N3906 PNP Compl. 2N3904	0.15
2N4400 NPN Low level noise	0.20
2N5401 PNP Nixie driver	0.25
1N4004 400PV 15 for 1.00	
1N4007 400PV 10 for 1.00	
1N746 3.3 Zen. 4 for 1.00	
1N4148 Switch 20 for 1.00	

## LOOK!

From Altaj to you, a special offer!  
Power Supply Kit, 5 Volt 1 Amp, Reg. Line regulation 0.05% Load regulation 50mV

Kit includes Components, PC Board, Transf., Fuse, Pilot Light. Nothing else to buy. \$6.50

**TTL 7400N**

SN7400N	15	SN74121N	36
SN7401N	15	SN74122N	42
SN7402N	15	SN74123N	59
SN7403N	15	SN74125N	45
SN7404N	18	SN74126N	45
SN7405N	18	SN74128N	65
SN7405N*	R	SN74132N	84
SN7406N	34	SN74136N	64
SN7407N	34	SN74141N	93
SN7408N	18	SN74142N	370
SN7409N	18	SN74143N	398
SN7410N	15	SN74144N	398
SN7411N	21	SN74145N	169
SN7412N	28	SN74147N	125
SN7413N	41	SN74148N	125
SN7414N	79	SN74150N	99
SN7416N	26	SN74151N	63
SN7417N	31	SN74153N	63
SN7420N	15	SN74154N	99
SN7421N	21	SN74155N	78
SN7422N	21	SN74156N	69
SN7423N	27	SN74157N	64
SN7425N	27	SN74159N	250
SN7426N	24	SN74160N	89
SN7427N	27	SN74161N	89
SN7428N	35	SN74162N	89
SN7430N	15	SN74163N	89
SN7432N	24	SN74164N	110
SN7433N	35	SN74165N	99
SN7437N	23	SN74166N	119
SN7438N	23	SN74167N	298
SN7440N	15	SN74170N	175
SN7442N	38	SN74172N	875
SN7443N	85	SN74173N	129
SN7444N	85	SN74174N	99
SN7445N	74	SN74175N	89
SN7446AN	78	SN74176N	79
SN7447AN	78	SN74177N	78
SN7448N	74	SN74178N	125
SN7450N	15	SN74179N	160
SN7451N	15	SN74180N	69
SN7453N	15	SN74181N	199
SN7454N	15	SN74182N	69
SN7460N	15	SN74184N	189
SN7470N	28	SN74185AN	185
SN7472N	27	SN74186N	695
SN7473N	31	SN74188N	350
SN7474N	31	SN74190N	109
SN7475N	48	SN74191N	109
SN7476N	34	SN74192N	88
SN7480N	39	SN74193N	88
SN7481AN	99	SN74194N	94
SN7482N	59	SN74195N	59
SN7483AN	69	SN74196N	93
SN7484AN	165	SN74197N	83
SN7485N	88	SN74198N	169
SN7486N	32	SN74199N	169
SN7489N	195	SN74221N	120
SN7490AN	45	SN74246N	195
SN7491AN	64	SN74247N	185
SN7492AN	46	SN74248N	175
SN7493AN	46	SN74249N	175
SN7494N	74	SN74251N	140
SN7495AN	69	SN74265N	85
SN7496N	69	SN74278N	245
SN7497N	285	SN74279N	245
SN74100N	99	SN74283N	145
SN74104N	43	SN74284N	450
SN74105N	43	SN74285N	450
SN74107N	29	SN74290N	85
SN74109N	49	SN74293N	85
SN74110N	54	SN74298N	198
SN74111N	74	SN74351N	192
SN74116N	175	SN74365N	65
SN74120N	140	SN74366N	65
		SN74367N	65
		SN74378N	65
		SN74390N	140
		SN74433N	140
		SN74490N	190

**ZENER DIODES**

IN472B-IN4752A	19
(1 watt molded)	
IN746A-IN759A	15
(400 MW)	

**MOS & BI-POLAR MEMORIES**

<b>FAIRCHILD</b>		
2102-IP	1K Static Ram 1024X1 (450NS)	2.50
3342PC	Quad 64 Bit Static Shift Register	4.50
3347PC	quad 80 Bit Static Shift Register	4.50
3341APC	4X64 Mos Fifo	4.50
4096-5DC	1 mhz Shift Register Isopolar 4K Dynamic Ram (350 NS) 16 pin	10.50
<b>TEXAS INSTRUMENTS</b>		
TMS0117NC	Decimal Arithmetic Processor	10.00
LCM1001	Microprocessor Learning Module	149.95
TMS3113NC	Dual 133 Bit Static Shift Register	4.95
TMS3112NC	Hex 32 Bit Static Shift Register	4.95
TMS4024NC	64X9 Fifo	8.95
TMS4030NL	4K Dynamic Ram Plastic 300 NS (22 Pin)	9.95
TMS4050NL	4X Dynamic Ram Plastic 300 NS (18 Pin)	9.95
TMS4060NL	4K Dynamic Ram Plastic 300 NS (22 Pin)	9.95
TMS4103NC	Input / Output Interface for 8080	10.00
TMS8080JL	8 Bit N-channel Microprocessor	29.95
<b>GENERAL INSTRUMENT</b>		
AY5-1013P	8 Bit Uart	6.95
AY5-2376	88X3X9 Keyboard Encoder	15.95

**M.I.L.**

MF1403AT	Dual 512 Dynamic Shift Register	2.95
MF1404AT	1024X1 Dynamic Shift Register	2.75
MF1702AR	256X8 Static PrOm Mos 8 Bit Cpu	12.95
MF8008R	500 Khz	12.95

**TTL LOW POWER SCHOTTKY**

SN74LS00N	25	SN74LS138N	149
SN74LS01N	25	SN74LS139N	149
SN74LS02N	25	SN74LS145N	125
SN74LS03N	25	SN74LS151N	125
SN74LS04N	30	SN74LS153N	125
SN74LS05N	30	SN74LS155N	145
SN74LS08N	25	SN74LS156N	145
SN74LS09N	25	SN74LS157N	125
SN74LS10N	25	SN74LS158N	120
SN74LS11N	25	SN74LS160N	195
SN74LS12N	25	SN74LS161N	195
SN74LS13N	69	SN74LS162N	195
SN74LS14N	135	SN74LS163N	195
SN74LS15N	25	SN74LS164N	198
SN74LS20N	25	SN74LS168N	225
SN74LS21N	25	SN74LS169N	225
SN74LS22N	25	SN74LS170N	280
SN74LS26N	40	SN74LS174N	140
SN74LS27N	30	SN74LS175N	140
SN74LS28N	30	SN74LS181N	350
SN74LS30N	25	SN74LS190N	95
SN74LS32N	37	SN74LS191N	95
SN74LS33N	39	SN74LS192N	95
SN74LS37N	39	SN74LS193N	95
SN74LS38N	39	SN74LS194A	140
SN74LS40N	30	SN74LS195A	140
SN74LS42N	110	SN74LS196N	145
SN74LS43N	110	SN74LS197N	145
SN74LS47N	110	SN74LS221N	135
SN74LS48N	110	SN74LS240N	250
SN74LS49N	110	SN74LS241N	250
SN74LS51N	25	SN74LS242N	240
SN74LS54N	25	SN74LS243N	240
SN74LS55N	25	SN74LS244N	250
SN74LS63N	1.75	SN74LS247N	130
SN74LS73N	49	SN74LS248N	130
SN74LS74N	49	SN74LS249N	130
SN74LS75N	69	SN74LS251N	155
SN74LS76N	49	SN74LS253N	155
SN74LS78N	49	SN74LS257N	160
SN74LS83AN	149	SN74LS258N	150
SN74LS85N	175	SN74LS266N	59
SN74LS86N	58	SN74LS279N	75
SN74LS90N	99	SN74LS283N	140
SN74LS91N	15	SN74LS290N	135
SN74LS92N	10	SN74LS293N	135
SN74LS93BN	99	SN74LS295AN	175
SN74LS95AN	160	SN74LS298AN	175
SN74LS96N	175	SN74LS324AN	225
SN74LS107N	49	SN74LS325AN	145
SN74LS109N	55	SN74LS353AN	170
SN74LS112N	49	SN74LS365AN	75
SN74LS113N	49	SN74LS366AN	75
SN74LS114N	49	SN74LS367AN	75
SN74LS122N	89	SN74LS368AN	75
SN74LS123N	109	SN74LS375AN	80
SN74LS124N	195	SN74LS386AN	59
SN74LS125N	75	SN74LS395AN	95
SN74LS126N	75	SN74LS670AN	295
SN74LS132N	125	SN74LS670AN	295
SN74LS136N	55		

We offer the largest variety of current production Texas Instruments and Fairchild Semiconductor only 74LS devices from stock. Even though the competition for current production major manufactured 74LS devices is limited, we are dedicated to provide the best prices possible. As our costs decrease, we pass the savings on to you, our customer.

**TEXAS INSTRUMENTS DATA BOOKS**

STK NO.	DESCRIPTION	PRICE
LCB1011	Understanding Solid State Electronics	2.95
LCB1041	Linear & Interface Applications	6.95
LCC4041	Power Data Book	3.95
LCC4111	TTL Data Book	3.95
LCC4131	Transistor & Diode Data Book	4.95
MCC4151	Linear & Interface I.C. Data Book	3.95
LCC4161	TTL Supplement Data Book	1.95
LCC4191	Optoelectronics Data Book	2.95
LCC4200	Semiconductor Memories Data Book	2.95

**FAIRCHILD DATA BOOKS**

Linear Integrated circuits	2.95
Data Book	
Low Power Schottky & Macrologic TTL	1.75
MOS/CMOS-N-MOS/P-MOS & charge coupled Devices	2.50
Interface Data Book	1.00
Full Line Condensed Catalogue	1.95

**GENERAL INSTRUMENT DATA BOOK**

Microelectronic & MOS Data Book	2.95
---------------------------------	------

**STANDARD MICROSYSTEMS**

COM2502	8 Bit Uart	7.95
COM2601	Universal Synchronous Receiver Transmitter	23.50
COM2017	8 Bit Uart	8.50

**CMOS**

CD4000BE	.10
CD4001BE	.19
CD4002BE	14
CD4006BE	119
CD4007BE	18
CD4008BE	85
CD4009BE	39
CD4010BE	.39
CD4011BE	.19
CD4012BE	.18
CD4013BE	.39
CD4015BE	.95
CD4016BE	.99
CD4017BE	.99
CD4018BE	1.09
CD4019BE	.44
CD4020BE	1.09
CD4021BE	1.15
CD4022BE	.95
CD4023BE	19
CD4024BE	.69
CD4025BE	18
CD4026BE	1.45
CD4027BE	.44
CD4028BE	.79
CD4029BE	.89
CD4030BE	.39
CD4033BE	1.70
CD4034BE	2.95
CD4035BE	1.05
CD4040BE	1.05
CD4041BE	.69
CD4042BE	.65
CD4043BE	.50
CD4044BE	.50
CD4049BE	.39
CD4050BE	.39
CD4051BE	1.20
CD4052BE	1.20
CD4053BE	1.25
CD4055BE	1.35
CD4056BE	1.50
CD4060BE	1.50
CD4066BE	.65
CD4068BE	.25
CD4069BE	.25
CD4070BE	.25
CD4071BE	.25
CD4072BE	.30
CD4073BE	.30
CD4075BE	1.10
CD4076BE	.30
CD4078BE	.25
CD4081BE	.30
CD4082BE	.25
CD4085BE	.75
CD4086BE	.75
CD4502BE	1.25
CD4507BE	.54
CD4510BE	1.10
CD4511BE	1.50
CD4512BE	1.20
CD4515BE	1.19
CD4518BE	.95
CD4519BE	.89
CD4520BE	.89
CD4528BE	1.25
CD4531BE	1.25
CD4539BE	1.20
CD4555BE	.75
CD4556BE	.75
CD4585BE	1.80
74C85/40085PC	1.20
74C160/40160PC	1.65
74C161/40161PC	1.65
74C162/40162PC	1.65
74C163/40163PC	1.65
74C174/40174PC	1.50
74C175/40175PC	1.50
74C192/40192PC	1.65
74C193/40193PC	1.65
74C194/40194PC	1.50
74C195/40195PC	1.50

**LED's**

<b>Litronix</b>	
IL1	1.05
IL5	1.15
IL12	.69
IL74	.83
RL2	23
<b>Texas Instruments</b>	
TIL111	.99
TIL112	.95
TIL113	1.25
TIL114	1.15
TIL116	1.20
TIL117	1.30
TIL118	.80
TIL119	.85
TIL138	2.25
TIL139	2.25
TIL209A	1.15
TIL211	.39
TIL220	.20
TIL221	.19
TIL222	.35
TIL23	1.98
TIL24	3.95
TIL302	3.98
TIL303	3.98
TIL304	3.98
TIL305	4.95
TIL306	7.95
TIL307	7.95
TIL308	7.95
TIL309	7.95
TIL311	8.95
TIL312	1.60
TIL313	1.60
TIL31	1.50
TIL32	.85
TIL63	.95
TIL66	.75
TIL78	.60
TIL81	1.20
LS600	2.10
<b>Fairchild</b>	
FCD802	.60
FCD806	.60
FCD810	.75
FCD820A	.75
FLV117	.18
MV5054-1	.75
FND357	1.75
FND500	1.75
FND507	1.75
FND807	3.00
FNS700	.60

**Plastic Power Transistors**

TIP29A	45	TIP116	80
TIP30C	59	TIP117	90
TIP31A	52	TIP121	125
TIP32A	55	TIP122	150
TIP33C	90	TIP125	135
TIP41A	65	TIP127	160
TIP42A	75	TIP295S	89
TIP4			

# Poly Pak's EXCLUSIVE Avg. Ship. \$1.98 Wt. 6 ozs.



YOUR CHOICE OF ANY KIT

100'S OF BARRELS PURCHASED! TEST 'EM YOURSELF 'N SAVE!

For the first time anywhere, Poly Pak merchandisers introduce a new way in buying the economical way. Raw stock from the "barrel". Remember the "good ole days"? They're back again. The same way merchandisers

throughout the United States buy from various factories... their overruns in barrels. Poly Pak has done the same. Therefore you are getting the same type of material as the RE-TESTERS DO!

Every kit carries a money-back guarantee.

<b>BARREL KIT #1</b> SN7400 DIP IC'S <b>75 for \$1.98</b> Cat. No. 10E2415 Untested.	<b>BARREL KIT #2</b> LINEAR OP AMPS, DIPS <b>75 for \$1.98</b> Un tested. Cat. No. 10E2416	<b>BARREL KIT #3</b> 1N4148/914 SWITCHING DIODES <b>100 for \$1.98</b> Cat. No. 10E2418 Untested.	<b>BARREL KIT #4</b> "4000" RECTIFIERS <b>100 for \$1.98</b> Untested. Cat. No. 10E2417
<b>BARREL KIT #7</b> VOLUME CONTROL BONANZA! <b>40 for \$1.98</b> Cat. No. 10E2421	<b>BARREL KIT #11</b> POWER TAB TRANSISTORS <b>40 for \$1.98</b> Cat. No. 10E2425 Untested.	<b>BARREL KIT #14</b> PRECISION RESISTORS Marked and unmarked <b>200 for \$1.98</b> No. 10E2428	<b>BARREL KIT #19</b> DIPPED MYLAR'S <b>60 for \$1.98</b> Cat. No. 10E2597 100% good
<b>BARREL KIT #20</b> LONG LEAD DISCS <b>150 for \$1.98</b> Cat. No. 10E2598 100% good	<b>BARREL KIT #25</b> METAL CAN TRANSISTORS <b>100 for \$1.98</b> Cat. No. 10E2603	<b>BARREL KIT #26</b> PLASTIC CAN TRANSISTORS <b>100 for \$1.98</b> Untested. Cat. No. 10E2604	<b>BARREL KIT #30</b> PERFORMED RESISTORS <b>250 for \$1.98</b> Cat. No. 10E2608 100% good
<b>BARREL KIT #31</b> METALLIC RESISTORS <b>100 for \$1.98</b> Cat. No. 10E2609	<b>BARREL KIT #37</b> 1 AMP "BULLET" RECTIFIERS <b>100 for \$1.98</b> Cat. No. 10E2615	<b>BARREL KIT #39</b> 2N3055 HOBBY TRANSISTORS <b>15 for \$1.98</b> 100% good. Cat. No. 10E2617	<b>BARREL KIT #58</b> SLIDE SWITCHES <b>30 for \$1.98</b> No. 10E2726 100% good
<b>BARREL KIT #61</b> POLYSTYRENE CAPS <b>100 for \$1.98</b> Cat. No. 10E2729	<b>BARREL KIT #68</b> 2 WATTERS <b>100 for \$1.98</b> 100% good. Cat. No. 10E2735	<b>BARREL KIT #71</b> CAPACITOR SPECIAL <b>100 pcs. \$1.98</b> 100% good. Cat. No. 10E2738	<b>BARREL KIT #73</b> TIP-RESISTOR ELECTROS <b>50 for \$1.98</b> Cat. No. 10E2747
<b>BARREL KIT #76</b> 1-WATT ZENERS <b>100 for \$1.98</b> Untested. Cat. No. 10E2741	<b>BARREL KIT #86</b> HOBBY LEADS <b>40 for \$1.98</b> Untested. Cat. No. 10E2859	<b>BARREL KIT #87</b> NATIONAL IC BONANZA <b>100 for \$1.98</b> Untested. Cat. No. 10E2860	<b>BARREL KIT #115</b> MOLEX SOCKETS <b>200 for \$1.98</b> Cat. No. 10E3144

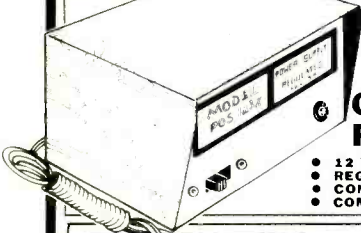

## 2250 CITIZENS BAND POWER SUPPLY

- 12 VDC @ 3 AMPS
- REGULATED, CONTINUOUS DUTY
- CONVERTS CB, HAM RIGS TO HOME
- COMPLETELY WIRED

CBers, ATTENTION! For your CB or Ham rigs, this 115V to 12VDC converter. Built-in automatic RESET circuit breaker. Powerful 3 amps (8 amps peak) makes it ideal for SSB rigs, too! Attractive walnut-like metal modern-design cabinet (5 1/2" x 2 1/4"). Big U.S. maker design. Built-in circuit breaker. Front panel has OFF-ON switch and LED light. For 115 VAC 60 cycle. Saves you money \$\$\$ too! Wt. 6 lbs. Cat. No. 10E3452

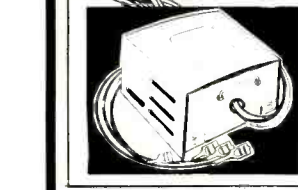

**ECC INDUSTRIAL SPEED CONTROL**  
Report of a sellout! A \$40 item, made by ECC famous for semiconductors, designed and built this speed control for NEROX. Controls home, shop and industrial lighting too. Rated at 1200 watts. A very elaborate circuit for controlling many electrical and electronic devices. Easily controls speeds of electric drills, brush type motors, etc. Built with heavy duty aluminum framing. Complete with external 60K pot. for variable speed control, and series resistor. Heavy duty colored wires for 115VAC 60 cycles, and item to be controlled. 10/32 mounting stud. Outperforms our previous sell-out. With hookup diagram. Use for temperature controller too. Wt. 2 lbs. Cat. No. 10E3392

## KEYBOARD & ENCODER KIT



- Double sided PC board
- Outputs — standard ASCII 7 bits plus strobe
- Uses Encoder MOS ROM
- 7 "LED" test feature
- 4 Modes
- 63-Key keyboard

**\$59.95 KIT**

Lowest price Keyboard and Encoder Kit we've seen. General purpose ASCII keyboard for data terminal applications. Could be used for TV, RTTY, Code Transmission, Altair and other Mini Computers, etc. Utilizes 2-key rollover MOS memory allowing encoded outputs to be strobed out as each key is depressed. Uses double side pc board. Electronic shift lock, not mechanical on keyboard. Keyswitches, one integral assembly not individual keys. Keyboard: 63 keys (49 encoded keys), 4 mode: normal, shift and control, 3 internal function keys: shift lock side of board, shift lock and control, 4 functions: Key Break, Here Is, Repeat, 7 additional functions can be assigned by user.

**\$69.95 WIRED**  
Electrical specs: voltage requirements plus 5 volts and minus 12 volts, 200ma, negative or positive logic output, jumper selectable. Output connector. On the PC board we have a NEW KEYBOARD TEST FEATURE: 7 LEDs! These LEDs display visually the ASCII code for the depressed key. TTL compatible. Kit includes: 63 key keyboard, pc board, ROM, 7 LEDs, resistors, capacitors, TTL IC's and SOCKETS. We include diagram and wiring instructions, ROM code. Wt. 7 lbs. Size overall: 13 x 7 1/2 x 8 1/2"

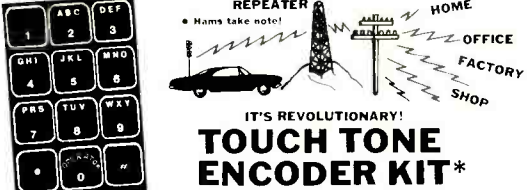

## TOUCH TONE ENCODER KIT\*

1.25M, 2-meter and 6-meter amateur radio operators, if your rig is mobile, convert it easily to a mobile telephone station and contact your home, shop, school, factory TTE-100 touch tone encoder kit. Kit includes: Chimerics touch tone pad, Motorola MC14110 chip, trimpot, resistors, zener, diodes, and G-10 pc board. Electrical specs: 12-16 volts, 3 ma (max), 1 volt. PP output. \* Less 1-MC crystal. Cat. No. 10E3385

**1995**

Cat. No.	Description	Sale	BUY 'EM SEPARATELY
10E3149	Touch Tone Pad	\$4.50	10E3383 P.C. Board
10E3382	MC14110 Chip	10.50	2.95

## DIGITAL CLOCK

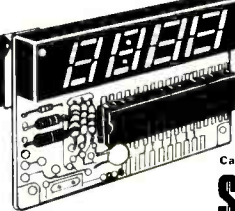

MODULE WITH BUILT-IN "CHIP"

Never before offered (as far as we know), the latest in Digital Clock circuitry — a 4-digit, 0.5" height, LED, built-in red filter, with a MM5385 multi-function alarm chip, mounted on a 3 x 1 1/2 x 3/4" module. Has all necessary discrete components mounted on module by factory to require only 16 function switches, brightness and voltage divider control, 12-16 volt filament transformer, AC line cord and case. Makes easy built-in alarm and radio output; switch functions: Seconds, Sleep timer up to 3-hour fast set. Snooze alarm display (tells you when snooze alarm triggers), Alarm display (tells you when alarm triggers).

Alarm ON/OFF. Instruction and hookup diagrams. Shpg. wt. 7 ozs.

**\$14.95**

**\$8.88**

- 3-5.6 Blades!
- 115 VAC!
- Compact!
- Lightweight!
- Only 4-11/16" sq. x 1 1/2" deep!

## Rotron Fans



Now anyone can afford these neat Muffin and Centaur Fans by Rotron. Used extensively for hi-fi (opt) because of low-cost, dependable cooling, as well as Pushing computers, power supplies, office equipment, light projectors, transmitters, receivers & more! Weighs only 1-lb. LOW NOISE LEVEL! Humidity & moisture resistant motor. IRVESHIRE AIR FLOW! Impedance protected. Suitable for -10°F to +140°F. Both 115 VAC, 1200 rpm, 15 watts, .16 amps, hi-impact, flame retardant polycarbonate propellers in a reinforced phenolic venturi block. Blow away high prices with our Muffin and Centaur fans! Removed from new equipment. Money back guarantee.

Cat. No.	Description	Shpg. wt.
10E3108	"Muffin" 3-blade	1 1/2 lbs.
10E3109	"Centaur" 22" 5-blade	
10E3110	"Centaur" 6-blade	

## FAIRCHILD, NATIONAL VOLTAGE REGULATOR PANIC

YOUR CHOICE \$1

- 1-AMP RATING
- TO-220 or TO-3 CASES
- POSITIVE OR NEGATIVE

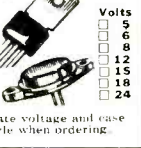

3 for \$2.75 Cat. No. 10E3449 Positive Voltage\*\* State voltage and case style when ordering.

3 for \$2.75 Cat. No. 10E3450 Negative Voltage\*\*

Type	Sale	2 for	Type	Sale	2 for
SN7400	.22	.23	SN7494	.82	.83
SN7401	.22	.23	SN7495	.86	.87
SN7402	.22	.23	SN7496	.86	.87
SN7403	.22	.23	SN74125	1.29	1.30
SN7404	.24	.25	SN74126	1.29	1.30
SN7405	.46	.47	SN74132	1.95	1.96
SN7407	.47	.48	SN74141	1.12	1.13
SN7408	.22	.23	SN74145	1.69	1.70
SN7409	.52	.53	SN74148	3.25	3.26
SN7410	.22	.23	SN74150	1.12	1.13
SN7411	.27	.28	SN74153	1.10	1.11
SN7417	.62	.63	SN74154	1.53	1.54
SN7420	.22	.23	SN74157	1.09	1.10
SN7421	.55	.56	SN74158	1.55	1.56
SN7422	.47	.48	SN74160	1.59	1.60
SN7425	.37	.38	SN74163	1.50	1.51
SN7430	.22	.23	SN74164	1.79	1.80
SN7432	.36	.37	SN74165	1.79	1.80
SN7440	.22	.23	SN74173	1.69	1.70
SN7442	.97	.98	SN74174	1.42	1.43
SN7445	.97	.98	SN74175	1.45	1.46
SN7446	1.10	1.11	SN74176	1.59	1.60
SN7447	1.10	1.11	SN74177	1.59	1.60
SN7450	.22	.23	SN74181	3.75	3.76
SN7451	.27	.28	SN74184	2.19	2.20
SN7473	.44	.45	SN74190	2.75	2.76
SN7475	1.00	1.01	SN74191	2.75	2.76
SN7483	.99	1.00	SN74193	1.29	1.30
SN7485	1.41	1.42	SN74195	.89	.90
SN7486	.47	.48	SN74196	2.19	2.20
SN7489	2.25	2.26	SN74198	2.25	2.26
SN7491	1.00	1.01	SN74199	2.25	2.26



**TTLs**

ORDER BY CAT. NO. 10E1983 & TYPE NO. AT LEFT

Cat. No.	Type	Sale	2 for
10E2310	8008	\$19.95	\$19.96
10E2855	212-2	2.50	2.51
10E2856	2102-1	2.95	2.96
10E2847	1101	.95	.96
10E1989	1103	1.50	1.51
10E2853	5266	5.95	5.96
10E2155-A	MMS203	9.95	9.96
10E2155-B	MMS202	6.95	6.96
10E2854	1702-A	9.95	9.96

## MEMORIES



Terms: Add postage. Rated: net 30  
Phone: Wakefield, Mass. (617) 245-3829  
Retail: 16-18 Del Carmine St., Wakefield.  
**MINIMUM ORDER — \$6.00**  
**POLY PAKS** Send for FREE Fall-Winter CATALOG  
P.O. BOX 942 E LYNNFIELD, MASS. 01940



## ORGAN KITS KEYBOARDS

THE ULTIMATE IN DESIGN  
AND SOUND  
FREE LITERATURE

Wurrlitzer reproductions

DEVTRONIX ORGAN PRODUCTS, Dept. C  
5872 Amapola Dr. • San Jose, CA 95129

**POLICE CODE UNSCRABLERS.** Fits all scanners. Satisfaction Guaranteed. Jim's Two-Way, Box 275, Hot Springs, Ark. 71901.

**NEW ADJUSTABLE THREE OUTPUT REGULATED POWER SUPPLY,** plus 900 parts worth \$400.00 list. Solid state CARTRIVISION television recorder electronic unit. Schematics, parts cross reference. HEATHKIT television transistor substitutions. Power CB radios, MICRO-PROCESSORS. \$17.95 plus \$3.50 S&H, USA. Free Brochure, Master Charge, BankAmericard. Satisfaction guaranteed. MADISON ELECTRONICS COMPANY, INCORPORATED, Box 369, D55, Madison, Alabama 35758.

500 MHZ Prescaler - 10 or ±100 \$59.95. Plans \$5.00. CBS, Box 1356, Cocoa Beach, Florida 32931.

**ORGAN/SYNTHESIZER** keyboards, pedalboards, amplifiers, consoles, etc. Free brochures DANIELSON, 555 Richmond Road, West Chester, PA 19380.

**LOW cost digital/analog test equipment.** Exceptional values. Free catalog Saien Electronics, Box 82, Skokie, Illinois 60076.

**DON'T LET VOLTAGE TRANSIENTS ZAP YOUR HI-FI.** Solid state equipment protector plugs into outlet protects any transistorized equipment. \$6.95. Kopp Electronics, 1650 William St., Buffalo, N.Y. 14206. Free Brochure.

**LEARN Design Techniques.** Electronics Design Newsletter, Digital, linear construction projects, design theory and procedures. Annual Subscription \$6.00, sample copy \$1.00. Valley West, Box 2119-B, Sunnyvale, CA 94087.

**PROFESSIONAL QUALITY PA MIXER.** Six Channels, reverb. Assemble yourself and save \$\$ Live sound, recording use. Lo-Hi Z inputs, stackable. \$179.50. Free Literature. Neptune Electronics, 934 N.E. 25th, Portland, Oregon 97232.

**SMOKE—Combustible Gas Alarm—\$17.95.** Free Information. Romar Systems, 85 - 78th Street, Brooklyn, NY 11209.

**CHEMLAB** has electronics, tools, hardware, chemicals, modelmaker supplies and more, write: Box 41472, Chicago, Ill. 60641.

**KITS:**  
**TV CLOCK & GAMES**  
**DIGITAL CLOCK KITS**  
**COIN GAME**  
**BINARY NUMBER GAME**  
TV FM AMPS - POWER SUPPLIES  
Send \$2 for your info. pack. refunded with purchase.  
We have the BEST kits at the BEST price! DO IT TODAY!!!  
**INTERFAB 27959C CABOT ROAD, LAGUNA NIGUEL, CA 92677**

**MOBILE IGNITION SHIELDING** for Hams, CB's, etc. Free literature. Estes Engineering, 930 Marine Drive, Port Angeles, Wash. 98362.

**SURPLUS 'SMART' TERMINALS,** components, serious music synthesizer kits, plans, parts, and more. Send SASE for FREE INFO Package. CFR Associates, POBF, Newton, N.H. 03858.

**CANADA'S electronics bargain centre.** Free Catalogue, North American and offshore inquiries welcomed. CANMOS, Box 1690, Peterborough, Canada K9J 7S4.

**FREE CATALOG.** Calculators \$4.95 each, Ultrasonic Devices, Digital Thermometers, Strobe Light Kits, Memories, Photographic Electronic Flash Units, Rechargeable Batteries, LEDs, Transistors, IC's, Piezoelectric Crystals, Toroidal Cores, Unique Components. Chaney's, Box 27038, Denver, Colo. 80227.

**CB RADIOS,** monitors, crystals, CD ignitions. Southland, Box 3591-B, Baytown, Texas 77520.

**The easy \$25 counter kit!**

An easy-to-build 50MHz (6-Digit) Frequency Counter for a measly \$25! Standard easy-to-find parts. 100! Uses 562ment LE0 readouts - no scarce Nixie tubes! No tricky crystal oven! Kit includes classy cabinet with front panel, PC boards, hardware, instructions, and diagrams. A proven design! An unbeatable offer! Write or call today! (Please add \$2 for postage and handling.)  
**HUFCD Box 357, Dept. 58 Provo, UT 84601 (801) 375-8566**



**SPECIAL this month.** IC sockets, staggered pins, 14 PIN DIP. 10/\$1.25 postpaid. Write for free surplus electronics flyer. R.W. Electronics, 3203 North Western Avenue, Chicago, Illinois 60618.

**CALCULATOR Keyboards,** 4 Function, 3-1/2" x 2-3/4", used \$1.50 (no C.O.D.). Mardel, P.O. 5312, Kansas City, MO 64131.

**FERRIC CHLORIDE ETCHANT,** 1/2 gallon \$5.50. Gallon \$9.50. Postpaid. CIRCOLEX, Box 198, Marcy, N.Y. 13403.

**DESIGNER MOTOR SET** includes 1/40, 1/70, 1/150, 1/250, 1/500 horsepower, 3000 RPM, 115 VAC \$27 postpaid. CIRCOLEX, Box 198, Marcy, N.Y. 13403.

**BUILD YOUR OWN SPEAKERS AND  
SAVE UP TO 50%**

You can assemble your own high quality, multi-element stereo speakers in a few hours and save up to half the cost of comparable speakers. Send for our free 32-page catalogue of speaker kits, raw speakers and accessories.

**SPEAKERLAB**  
Dept. PE-9 5500-35th N.E.  
Seattle, Washington 98105



**BASIC TELEPHONE WIRING—**Unique report gives complete details about connecting telephones. \$3.50. QUEENS VILLAGE TELEPHONE SUPPLY, Box 29002-A, Queens Village, New York 11429.

**SAVE MONEY ON ELECTRONIC PARTS.** Catalog 50 cents, refundable with first order. Supreme Electronics, Box 327, Victoria, B.C., Canada. U.S. inquiries welcome.

**GAS AND SMOKE DETECTOR**  
Protect Your Family, Home, Office, Factory and Garage

Detects within seconds and sounds a loud alarm if minute quantities of carbon monoxide, propane, butane, methane, cooking gas, gasoline vapor, inflammable solvents, ammonia, alcohol, vapor, smoke and most products of combustion are present in the air. Plugs into any 115 volt outlet. Install it yourself in minutes. Provides years of continuous protection without attention—guaranteed.

**\$49.95** Each Two or more **\$44.95** Each Ill. res. add 5% tax  
Nu-Era Products Dept. 11 P.O. Box 29086 Chicago, Ill. 60629

**BIOFEEDBACK:** High Performance EEG, EMG instruments. Assembled or low cost kit form. Write for complete specifications. EDC, Box 9161, Berkeley, CA 94709.

**ANYONE CAN SOLDER WITH—**

**DO-IT-YOURSELFERS!**

Let Kester solder aid you in your home repairs or hobbies. A radio, TV, model train, jewelry, plumbing, etc. Save money—repair it yourself. For valuable soldering information write Kester for your FREE copy of "Soldering Simplified".

**KESTER SOLDER /** 4201 Wrightwood Ave.  
Chicago, Ill. 60639



### OCTOBER SPECIALS

**TTL**

7410	\$.12	4001	\$.19
7438	.16	4002	.20
7454	.09	4009	.39
74151	.59	74C00	.14
74153	.65	74C73	.69
74154	.98		
74192	.79		

**CMOS**

4001	\$.19	180 carbon film resistors ± 5%, 1/4 or 1/2 watt. 15 each of 12 values. First quality resistors supplied in a durable clear styrene utility box with color code chart.
4009	.39	Includes 15 each 100, 220, 470, 1K, 1.5K, 3.3K, 4.7K, 6.8K, 10K, 33K, 100K, 1M.

**8038 FUNCTION GENERATOR** JUMBO LED  
Voltage controlled oscillator — sine, Red .12  
Square, triangular output. 16 pin DIP Green .12  
with data \$3.95 Yellow .12

**2102 RAM**  
1024 bit fully decoded static RAM  
1024 bit compatible — 16 pin DIP 1.69

**IC BREADBOARD**  
Accommodates 5 16 pin IC's with additional interconnection holes. 1/16" phenolic with all plated copper circuits. 2.5/16" x 6.9/16" \$1.80 ea.

**RESISTOR KIT \$9.95**

**LINEAR**

370	\$ .95
380	.89
555	.39
723	.39
733	.65
1310	1.79

**CALCULATOR CHIPS**

340T-5v	.99
340T-15v	.99

**MEMORIES**

1103	\$ .95
1702	8.95
5203	8.95
MAN1	1.39
NSN71L	1.19
NSN74	1.19
MAN8	1.39
F93410	1.39

**DVM CHIP 4 1/2 DIGIT**  
MM 5300 — P channel device provides all logic for 4 1/2 digit volt meter. 16 pin DIP with data 9.95

**MEMORIES**

1101	256 bit RAM MOS 16 pin	1.39
1103	1024 bit RAM MOS dynamic 18 pin	1.95
1702A	2048 bit PROM static electrically programmable UV erasable 24 pin	10.95
2102	1024 bit RAM static 16 pin	1.95
2203	2048 bit PROM static electrically programmable UV erasable 24 pin	10.95
3260	1024 bit RAM MOS dynamic 16 pin	1.95
5261	1024 bit RAM MOS dynamic 16 pin	1.95
7489	64 bit ROM TTL 16 pin	2.25
82523	256 PROM-SCHOTTKY 16 pin	3.69
F93410	256 bit RAM bi-polar 16 pin	1.95
74187	1024 bit ROM TTL 16 pin	5.75
74200	256 bit RAM tri-state 16 pin	5.45

**DISCRETELED'S**

MAN1	\$1.95	MV50	.29
MAN2	1.95	NSL100	.12
MAN3	2.25	NSL101	.12
MAN6	2.49	NSL102	.15
MAN7	1.49	MV502	.15
MAN8	2.25	RED	.15
MAN66	2.25	GREEN	.15
DI10A	2.19	AMBER	.15
FND500	1.89	CLAR	.15
NS71L	1.39		

**DISPLAYS**

301	.29	139	1.58	562	3.39
102	53	140K	1.69	565	1.18
104	80	170	1.20	566	1.95
105	71	172	2.93	567	1.95
107	26	173	2.42	709	.26
108	1.35	176	6.88	710	.35
309A	89	180	3.00	711	.76
310	1.07	180	3.00	719	1.07
311	.95	180-8	1.25	741	.32
319	1.13	181	1.75	747	.71
1201	1.39	321	2.95	748	.35
120X	1.39	540	2.95	75491	.71
122	1.70	566A	1.19	75492	.80

**SPECIAL DEVICES**

372	AF-IF Strip Detector DIP	2.93
546	AM Radio Receiver Subsystem DIP	2.95
1310	FM Stereo Demodulator DIP	.70
1496	Balanced Modulator-DEM-Modulator	.99
1800	Stereo multiplexer DIP	2.48
LILN208	FM Gain Block 34db (typ) MDIP	1.18
LILN209	FM Gain Block 48db (typ) MDIP	1.35
2513	Character Generator 64x8x5 DIP-24	10.20
3046	Transistor Array DIP-14	.73

THESE DISCOUNTS APPLY TO TOTAL OF ORDER — SPECIALS INCLUDED

**10% OFF ON ORDERS OVER \$25**  
**15% OFF ON ORDERS OVER \$100**

LARGE QUANTITY PRICING AVAILABLE ON REQUEST  
PLEASE SPECIFY ITEM AND QUANTITY

**OPTO ISOLATORS**

MCD2	Opto isolator diode	1.09
MCT2	Opto isolator transistor	.70

**CALCULATOR CHIPS**

CTS002	1.95	CLOCK CHIPS	
CTS005	1.95	MM5311	4.45
MM5725	2.49	MM5312	4.45
MM5736	1.98	MM5314	4.95
MM5738	3.95	MM5316	4.95
MM5739	3.95	5375A	5.95
		CT7001	4.95

**FREE CATALOG AVAILABLE ON REQUEST INCLUDES:** RESISTORS +1% & +5%, TANTALUM CAPACITORS, POWER SUPPLY KITS, CLOCK KITS, TOOLS, RESISTOR & CAPACITOR KITS & MISCELLANEOUS DEVICES

**FREE CATALOG AVAILABLE ON REQUEST**

Satisfaction guaranteed. Shipment will be made postage prepaid within 3 days from receipt of order. Payment may be made with personal check, charge card (include number and exp. date), or money order. Phone Orders — BoIA and M/C card or C.O.D.

Add \$1.00 to cover shipping and handling if order is less than \$10.00.  
California residents add sales tax. Include shipping expense for orders shipped out of U.S. and Canada approx. 10% of order.

**INTERNATIONAL ELECTRONICS UNLIMITED**  
P.O. BOX 3036-P MONTEREY, CA. 93940 USA  
PHONE (408) 659-3171

118      CIRCLE NO. 35 ON FREE INFORMATION CARD      POPULAR ELECTRONICS

www.americanradiohistory.com

# 6 Digit LED Clock Kit - 12/24 hr.

**\$9<sup>95</sup>** ea. QTY. 12 OR MORE

**\$10<sup>95</sup>** ea. QTY. 6-11

**\$11<sup>95</sup>** ea. QTY. 1-5

- KIT INCLUDES**
- INSTRUCTIONS
  - QUALITY COMPONENTS
  - 50 or 60 Hz OPERATION
  - 12 or 24 HR OPERATION

- 6-LED Readouts(FND-359 Red, com. cathode)
- 1-MM5314 Clock Chip (24 pin)
- 13-Transistors
- 3-Switches
- 6-Capacitors
- 5-Diodes
- 9-Resistors
- 24-Molex pins for IC socket

**LARGE .4" DIGITS!**  
**ORDER KIT #850-4**  
**AN INCREDIBLE VALUE!**

"Kit #850-4 will furnish a complete set of clock components as listed. The only additional items required are a 7-12 VAC transformer, a circuit board and a cabinet, if desired."

Printed Circuit Board for kit # 850-4 (etched & drilled fiberglass) .....\$2.95  
 Mini-Brite Red LED's (for colon in clock display) pkg. of 5 ..... 1.00  
 Molded Plug Transformer 115/10 VAC (with cord) ..... 2.50  
 NOTE: Entire Clock may be assembled on one PC Board or Board may be cut to remote display.  
 Kit # 850-4 will fit Plexiglas Cabinet II.



## PLEXIGLAS CABINETS

Great for Clocks or any LED Digital project. Clear-Red Chassis serves as Bezel to increase contrast of digital displays.

**Black, White or Clear Cover**

**\$6.50 ea. 2/\*12.**

**CABINET I**  
**3"H,6 1/4"W,5 1/2"D**  
**CABINET II**  
**2 1/2"H,5"W,4"D**

ANY SIZE / COLOR

**RED OR GREY PLEXIGLAS FOR DIGITAL BEZELS**

3"x6"x1/8"

**95¢ ea. 4/\*3**

**60 HZ.**  
**XTAL TIME BASE**  
 Will enable Digital Clock Kits or Clock-Calendar Kits to operate from 12V DC. 1"x2"PC Board Power Req: 5-15VDC (2.5 MA. TYP.) Easy 3 wire hookup Accuracy: ± 2PPM (Adjustable) Complete Kit **\$4<sup>95</sup>** ea.

**SEE THE WORKS** Clock Kit Clear Plexiglas Stand

- 6Big .4" digits
  - 12 or 24 hr. time
  - 3 set switches (back)
  - Plug transformer
  - all parts included
- Plexiglas is Pre-cut & drilled Size: 6"H,4 1/3"W,3"D

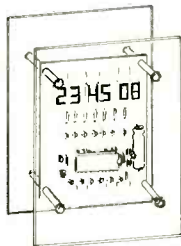

**A SUPER LOOKING CLOCK!**

Kit #850-4 CP

**\$23<sup>50</sup>** ea. **2/\*45.**

## 6 Digit-LED Clock-Calendar-Alarm Kit

- 12/24 HR TIME • CHOICE OF DIGITS • 28-30-31 DAY CALENDAR • AC FAILURE/BATTERY BACK-UP • 24 HR ALARM - 10 MIN. SNOOZE • ALTERNATES TIME [8 SEC] AND DATE [2 SEC] OR DISPLAYS TIME ONLY AND DATE ON DEMAND • THIS KIT USES THE FANTASTIC CT-7001 CHIP. FOR THE PERSON THAT WANTS A SUPER CLOCK KIT-TOO

**MANY FEATURES TO LIST!**

- #7001 B [6-.4" Digits/Man-64] **\$39.95**
- #7001 C [4-.6" Digits/2-.3" Seconds] **\$42.95**
- #7001 D [4-.8" Digits/2-.3" Seconds] **\$45.95**

ALL KITS ARE COMPLETE INCLUDING IC SOCKET, TRANSFORMER, LINE CORD, SWITCHES, etc.

Cabinet not included (Ideal fit in Cabinet I above)

**1/2" DIGIT CLOCK KIT** A COMPLETE KIT LESS CABINET. FEATURES: MM5314 IC, 12/24 HR, 50/60 HZ, 6-FND-503 LED'S, PLUG-TRANSFORMER, LINE CORD, etc. [Ideal Fit in Cabinet II] **\$19<sup>95</sup>** ea. **2/\*38.**  
 Kit #5314-5.....

**Fairchild Super Digit FND-359**  
 4" Char. Ht. 7 segment LED RED Com. Cath. Direct pin replacement for popular FND-70.  
**95¢ ea, 10/\$8.50**  
**100/\$79.00**

CLOCK IC'S			
CT-7001.....	7.95	CT-7002.....	13.95
MM5314N...	3.95	MM5369N....	2.50
MM5316N...	4.95	MM5375AB..	3.95

IC SOCKETS		Solder Tail	
Pin	Profile	1-24	25 100
14	LP	\$.25	\$.22 \$.20
16	LP	.28	.25 .23
18	LP	.31	.28 .26
24	SP	.50	.45 .40
28	SP	.60	.55 .50
40	LP	.75	.70 .65

**JUMBO DIGIT CONVERSION KIT**  
 Convert small digit LED clock to large .5" displays. Kit includes 6-.5" LED's, Multiplex PC Board & easy hook-up info. Kit #JD-1CC For common Cathode **\$9<sup>95</sup>** ea. **2/\*19.**  
 Kit #JD-1CA For common Anode

**SET OF 6 FND-359 WITH MULTIPLEX PC BOARD \$6.95**

**25 AMP BRIDGE**  
**\$1.95 ea.**  
**3/\$5.00**  
 100 PIV

**NYLON WIRE TIES**  
 8" for bundle dia. 1/4"-1-3/4" 100/\$1.95  
 4" for bundle dia. 1/16"-3/4" 100/\$1.75

**Form Inexpensive Sockets** **MOLEX PINS**  
 100 for \$1.25  
 Reel of 1000 - \$8.50

**DIODES**

IN4002	12/\$1.00
IN4003	12/\$1.00
IN4005	11/\$1.00
IN4007	10/\$1.00
2.5A/1000PIV	5/\$1.00
IN5400	5/\$1.00
IN914	20/\$1.00
IN4148	20/\$1.00

**SWITCHES**

ROCKER SPDT	6/\$1.
MINI-SLIDE SPDT	5/\$1.
REG. SLIDE DPDT	6/\$1.
PUSH BUTTON N.O.	3/\$1.

**TRANSISTORS 5/\$1.00**  
 All Prime Marked Units

2N2222A	NPN	TO-18
2N3415	NPN	TO-92
2N3704	NPN	TO-92
2N4249	PNP	TO-92
2N4400	NPN	TO-92
2N4437	NPN	TO-92
2N5089	NPN	TO-92
2N6027	PUT	TO-92

**TRANSISTOR SOCKET GOLD PINS**  
**5/\*1.00**

**TELEPHONE FORMAT KEYBOARD**  
 BY Chomerics

2-1/9"x3"  
 5/32" thick  
**\$4.95**  
**6/\*28.**

## 7-SEG LED

**COMMON CATHODE**

HP5082-7702	RED	.3"	1.25
FND-71	± 1	.25"	.75
FND-359	RED	.4"	.95
FND-503	RED	.5"	1.35
FND-803	RED	.8"	3.50
DL-33MMB	RED	3x.1"	.75
DL-750	RED	.6"	2.95
XAN-654	GREEN	.6"	2.95 (no D.P.)
XAN-664	RED	.6"	2.95 (no D.P.)

**JUMBO RED LED's Pkg. of 50 \$3<sup>95</sup>**

**10K 10 TURN SPECTROL POT** SPECTROL 95c  
 3/8"x3/8"x1/4" High #50-4-11-103 **4/\$3.00**

# OPTOELECTRONICS, inc.

BOX 219 • HOLLYWOOD, FLA. 33022 • (305) 921-2056

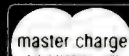

**ORDER BY TELEPHONE**  
 USE BAC, MC or COD  
 Orders Under \$15 Add \$1 Handling  
 COD Charge - \$1.00  
 Fla. Res. Add 4% Tax

WE PAY ALL SHIPPING IN CONTINENTAL USA — OTHERS ADD 5% [10% FOR AIRMAIL]





TV TECHNICIANS, SERVICEMEN, HOBBYISTS—Vista Model 740 Digital Crosshatch Generator. Compact crystal divider for lowest-priced ultra-stable 5x7 crosshatch or 56 dot patterns. AC powered. \$31.95 complete kit; \$41.95 assembled. Postpaid in USA, Canada. Information available free. Phototune Corporation, Dept. PE-106, 118 East 28th Street, New York, New York 10016.

PLANS—Video Pong... \$2.00 Laser... \$2.00 Projection TV... \$2.00. Catalog 50 cents. Technologic, Box 5262, Orchard Lake, Michigan 48033.

STEREO HOBBYISTS, add an automatic level control to your present tape recorder 20-20,000 Hz 0.5% THD, and 1 db. send for circuit diagram and parts list, w/ \$2.00 to Weston Electronics, P.O. Box 21, Bridgeport, Pennsylvania 19405. Ask us about other circuits.

LABORATORY RF, DC, and Special Instruments and Recorders. Send for list. Will trade for modern 2-way Shop Equipment. Elmo Black, 413 NE. 38 Terrace, Oklahoma City, OK 73105.

ELECTRONIC INSTRUMENTS. Test Equipment and Parts sold surplus. Catalog 50 cents, refund with order. MCI, Dept. EE, 420 Park Ave., Perth Amboy, N.J. 08861.

EMERGENCY VEHICLE Equipment Catalog \$2.00 (\$3.00 refund w/first order). Vehicle Systems, Box 101, Mastic Beach, N.Y. 11951.

FUNCTION GENERATOR PCB using 8038 IC. Provisions for power supplies, variable offset, duty, amplitude, frequency. Complete instructions. \$7.00. Telus Electronics, 77 Leacock Drive, Ottawa, Canada K2K 1S5. U.S. Inquiries:

SURPLUS TEST EQUIPMENT. CB repairmen fight RFI with 10MHz-44Ghz Spectrum Analyzer for \$275. American Calibration Services, Box 8104, Athens, GA 30601. (404) 725-7783.

SCHEMATICS. Complete electronic security system schematic package. Coleman, Box 2134-F, Station A, Champaign, Illinois 61820.

JAPANESE TRANSISTORS, all transistors original factory made. Free catalog. West Pacific Electronics, P.O. Box 3879, Torrance, CA 90510.

CLOSE-OUT SALE, keyboards for synthesizers \$50. Interface with Gnome Microsynthesizer. Use with Lancaster project. Brinkwood Electronics, Box 26, Sandy Spring, MD 20860.

COMPUTER HOBBYISTS! Bargain hunt and sell via ON LINE 18 issues/year — \$3.75. Free Sample ON LINE, 24695 Santa Cruz Hwy., Los Gatos, CA 95030.

ELECTRONIC ignition: Capacitor-Discharge, pointless, Auburn Sparkplugs Wheel Stabilizers, information 20 cents. Anderson Engineering, Epsom, N.H. 03234.

# IC BONANZA

\*Data Sheet included on these items

Part Number	Description	Price
*2102	Data Cassettes Used	
*5203Q	Good Condition	\$ 99
*MM5330	1K Static RAM	1.49
*50310	Erasable PROM 2K	10.95
*50250	National DVM Chip	9.95
304H	Slide Rule Calculator Chip	3.95
309K	Alarm Clock Chip	4.45
7812	Neg. Regulator	95
7815	5 Volt Regulator	95
MAN 7	12 Volt Pos. Reg. (TO-220)	79
MAN 3	15 Volt Pos. Reg. (TO-220)	79
MCA 8	(HP-7730) 7 Seg. Display	1.15
LED	7 Seg. Display	5/1.00
LED	Monsanto Opto Switch	75
LED	2 Red	6/1.00
LED	2 Yellow	5/1.00
LED	2 Green	5/1.00
LED	2 Red-Right Angle	5/1.00
LED	12 Red	7/1.00
LED	12 Yellow	6/1.00
LED	12 Green	6/1.00
1	Perforator Tape per roll	2.75
	7 Roll Carton	17.50

SEND FOR FREE CATALOG

Minimum order \$5.00, data sheets 25 cents each include 5% of order for postage and handling. Texas residents include 5% state sales tax.

## BONANZA ELECTRONICS

P.O. Box 24767 Dallas, Texas 75224

6 MHz CRYSTALS including schematic and info to generate 60 Hz-12VAC to make your digital clock run on batteries \$10.50 pp in US. Eastern Sales, Box 510, Raleigh, N.C. 27602.

## BUILD YOUR OWN TV CAMERA!

*Ideal for home & business*

THE ECONOMIC ANSWER TO HOME MONITORING OF NURSES, ENTRANCES, DRIVEWAYS... BUSINESS AND INDUSTRIAL SURVEILLANCE... TV... AMATEUR TV PLUS HUNDREDS OF OTHER APPLICATIONS. MODEL AT-1A. SERIES D KIT FORM \$12.95 ASSEMBLED \$375. SOLID-STATE. WORKS ON ANY TV SET. OPTIONAL SOUND KIT \$28.95. PHONE OR WRITE for catalog. Dial 402-981-3771

1001 BROADWAY ATV Research DAKOTA CITY, NE 68731

USE LED displays confidently. \$3.25 book describes theory and practical usage. Free catalog: LHC, Box 453, Littleton, MA 01460.

## 500 MHz COUNTER

±.0002% Accuracy

Kit \$249.95  
Assembled \$349.95

8 Digit LED Readout, 10 MHz TCXO ± 2 ppm from 15 to 50°C, Sensitivity - 30 mv @ 30 MHz, 150 mv @ 500 MHz. Size 8.8x8.2x8".

Davis Electronics, 636 Sheridan Dr., Tonawanda, N.Y. 14150 (716) 874-5848

YOU WANT TO BUILD IT. WE WANT TO HELP. WE SELL CONSTRUCTION PLANS with an Engineering Service. TELEPHONE: Answering Machines, Speakerphones, Car-phones, Phonevision Touch Button Dialers. TELEVISION: VTR, 1" Color TV Set, PONG \$25.00 Camera. COLOR PROJECTION TV. HOBBYIST: Electron Microscope, \$75 software programmable computer. BROADCAST Special Effects Generator, Chroma Key, Audio Board, DA'S COURSES: Telephone Engineering \$52.00, Detective Electronics \$29.50, IC Engineering \$65.00. PLUS MUCH MORE. NEW Super Hobby Catalog PLUS year's subscription to Electronic News Letter AIR MAILED \$1.00. Don Britton Enterprises, 6200 Wishire Blvd., Los Angeles, Calif. 90048.

## CB-PATROL CAR DOOR DECALS-CB

SCARE THIEVES AWAY, PROTECT CB GEAR AND PROPERTY! Beautiful full color designs, made from weather resistant mylar, looks like smokes! Use for: car, truck, boat, home, rv, etc. Complete CB ID kit of ten decals - ONLY \$6.95!! Write decals.

Dept. PE, CAMPBELL CO.  
P.O. Box 201, SAN GABRIEL, CA. 91776

CARBON FILM RESISTORS. Brand new as low as 1.7 cents. Discounts of 20% Prompt delivery. FREE samples/specifications. COMPONENTS CENTER, Box 134P, N.Y., N.Y. 10038.

CB RADIO, Scanners, Antennas. The best for less. Free List. Capitol Sound, Box 3523, Des Moines, Iowa 50322.

## BLINK 'N' BOOPER

IS HERE!!

The Memory Concentration Timing Game.

Send \$1.00 (refundable with order) for illustrative information packet! Includes technical description, circuit functions, component list, and game dynamics.

visulex P.O. Box 4204P Mountain View, CA 94040

## QUALITY ELECTRONIC COMPONENTS

### NEW DISCOUNT SCHEDULE SAVES YOU EVEN MORE!

# 8080A \$29.95 2102-1 \$1.99

MICROPROCESSOR 1024 Bit Random Access Memory  
0-70°C 480 ns Clock Period 500 ns Max Access Time

INTEGRATED CIRCUITS — TTL, CMOS, LINEAR & MOS

7400	21	7473	30	74174	98	4001	23	4073	23	23
7401	21	7474	30	74175	98	4002	23	4075	23	23
7402	21	7475	49	74176	79	4006	1.23	4081	27	23
7403	21	7476	32	74177	79	4007	23	4082	23	23
7404	21	7480	70	74180	70	4008	79	4502	79	23
7405	21	7482	70	74181	2.15	4009	44	4510	1.14	1.14
7406	25	7483	40	74182	67	4010	44	4511	1.09	1.09
7407	25	7485	89	74184	2.19	4011	23	4514	2.80	2.80
7408	21	7486	28	74185	2.19	4012	23	4515	2.80	2.80
7409	21	7489	2.19	74186	2.19	4013	44	4516	1.23	1.23
7410	21	7490	44	74189	3.50	4014	96	4518	1.14	1.14
7411	21	7491	70	74190	1.23	4015	96	4520	1.14	1.14
7412	21	7492	44	74191	1.23	4016	40	4527	1.68	1.68
7413	25	7493	44	74192	68	4017	1.05	4528	88	88
7414	89	7494	70	74193	88	4018	1.05	4585	1.83	1.83
7416	25	7495	70	74194	88	4019	23	LM309K	1.20	1.20
7417	25	7496	70	74195	88	4020	1.14	LM324N	1.26	1.26
7420	21	7420	30	74196	88	4021	1.14	LM340-5	1.25	1.25
7421	25	74107	30	74197	88	4022	96	LM340-6	1.25	1.25
7423	35	74109	33	74198	1.49	4023	23	LM340-8	1.25	1.25
7425	35	74121	33	74199	1.49	4024	84	LM340-12	1.25	1.25
7426	25	74122	44	74251	1.09	4025	23	LM340-15	1.25	1.25
7427	33	74123	61	74279	58	4026	1.68	LM340-18	1.25	1.25
7428	28	74125	40	74365	67	4027	40	LM340-24	1.25	1.25
7430	21	74130	30	74366	67	4028	89	LM3900N	3.88	3.88
7432	25	74132	70	74367	67	4029	1.14	NE536T	3.24	3.24
7433	30	74141	88	74368	67	4030	23	NE540L	2.04	2.04
7437	25	74145	70	75150	71	4033	1.51	NE555V	1.83	1.83
7438	25	74147	63	75450	88	4034	3.50	NE555A	88	88
7440	21	74148	30	75451	61	4035	1.14	NE560B	3.83	3.83
7441	88	74150	16	75452	61	4040	1.14	NE561B	3.83	3.83
7442	53	74151	70	75453	61	4041	79	NE562B	1.83	1.83
7443	63	74153	65	75454	61	4042	79	NE565A	88	88
7444	63	74154	1.03	75491	81	4043	70	NE566V	1.26	1.26
7445	70	74155	70	75492	84	4044	70	NE567V	1.36	1.36
7446	70	74156	70	75493	1.09	4046	1.86	UA709CV	4.44	4.44
7447	70	74157	70	75494	1.19	4049	40	UA710CA	44	44
7448	70	74160	88	8093	40	4050	40	UA711CA	53	53
7450	21	74161	88	8094	40	4051	1.26	UA723CA	60	60
7453	21	74162	88	8095	67	4052	1.26	UA741CA	44	44
7454	21	74163	88	8096	67	4053	1.26	UA747CA	60	60
7460	21	74164	96	8097	67	4060	1.58	UA748CV	49	49
7470	30	74166	1.26	8098	67	4066	79	MC1458V	53	53
7472	30	74170	2.64	82525	2.19	4071	23	2102	1.99	1.99
7473	30	74173	1.42	4000	23	4072	23	8080A	29.95	29.95

## BISHOP GRAPHICS Printed Circuit Drafting

Aids are now available from Digi-Key

### DATA BOOKS

TTL IC's - 592 pages	... \$4.00	INTERFACE IC's - 464 pages	... \$4.00
LINEAR IC's - 704 pages	... \$4.00	VOLTAGE REGULATORS - 128 pages	... \$3.00
CMOS IC's - 256 pages	... \$3.00	LINEAR APPLICATIONS - 432 pages	... \$4.00
TRANSISTORS - 288 pages	... \$3.00		
MEMORY IC's - 592 pages	... \$3.00		

### SILICON TRANSISTORS

MP5918, MP5930, MP5222A, MP5236A, MP5271Z, MP5290A, MP5339Z, MP5339J, MP5339K, MP5339L, MP5353, MP5355, MP5358, MP5363B, MP5364D, MP5364I, MP5364J, MP5364K, MP5364L, MP5364M, MP5364N, MP5364O, MP5364P, MP5364Q, MP5364R, MP5364S, MP5364T, MP5364U, MP5364V, MP5364W, MP5364X, MP5364Y, MP5364Z, MP5364AA, MP5364AB, MP5364AC, MP5364AD, MP5364AE, MP5364AF, MP5364AG, MP5364AH, MP5364AI, MP5364AJ, MP5364AK, MP5364AL, MP5364AM, MP5364AN, MP5364AO, MP5364AP, MP5364AQ, MP5364AR, MP5364AS, MP5364AT, MP5364AU, MP5364AV, MP5364AW, MP5364AX, MP5364AY, MP5364AZ, MP5364BA, MP5364BB, MP5364BC, MP5364BD, MP5364BE, MP5364BF, MP5364BG, MP5364BH, MP5364BI, MP5364BJ, MP5364BK, MP5364BL, MP5364BM, MP5364BN, MP5364BO, MP5364BP, MP5364BQ, MP5364BR, MP5364BS, MP5364BT, MP5364BU, MP5364BV, MP5364BW, MP5364BX, MP5364BY, MP5364BZ, MP5364CA, MP5364CB, MP5364CC, MP5364CD, MP5364CE, MP5364CF, MP5364CG, MP5364CH, MP5364CI, MP5364CJ, MP5364CK, MP5364CL, MP5364CM, MP5364CN, MP5364CO, MP5364CP, MP5364CQ, MP5364CR, MP5364CS, MP5364CT, MP5364CU, MP5364CV, MP5364CW, MP5364CX, MP5364CY, MP5364CZ, MP5364DA, MP5364DB, MP5364DC, MP5364DD, MP5364DE, MP5364DF, MP5364DG, MP5364DH, MP5364DI, MP5364DJ, MP5364DK, MP5364DL, MP5364DM, MP5364DN, MP5364DO, MP5364DP, MP5364DQ, MP5364DR, MP5364DS, MP5364DT, MP5364DU, MP5364DV, MP5364DW, MP5364DX, MP5364DY, MP5364DZ, MP5364EA, MP5364EB, MP5364EC, MP5364ED, MP5364EE, MP5364EF, MP5364EG, MP5364EH, MP5364EI, MP5364EJ, MP5364EK, MP5364EL, MP5364EM, MP5364EN, MP5364EO, MP5364EP, MP5364EQ, MP5364ER, MP5364ES, MP5364ET, MP5364EU, MP5364EV, MP5364EW, MP5364EX, MP5364EY, MP5364EZ, MP5364FA, MP5364FB, MP5364FC, MP5364FD, MP5364FE, MP5364FF, MP5364FG, MP5364FH, MP5364FI, MP5364FJ, MP5364FK, MP5364FL, MP5364FM, MP5364FN, MP5364FO, MP5364FP, MP5364FQ, MP5364FR, MP5364FS, MP5364FT, MP5364FU, MP5364FV, MP5364FW, MP5364FX, MP5364FY, MP5364FZ, MP5364GA, MP5364GB, MP5364GC, MP5364GD, MP5364GE, MP5364GF, MP5364GG, MP5364GH, MP5364GI, MP5364GJ, MP5364GK, MP5364GL, MP5364GM, MP5364GN, MP5364GO, MP5364GP, MP5364GQ, MP5364GR, MP5364GS, MP5364GT, MP5364GU, MP5364GV, MP5364GW, MP5364GX, MP5364GY, MP5364GZ, MP5364HA, MP5364HB, MP5364HC, MP5364HD, MP5364HE, MP5364HF, MP5364HG, MP5364HH, MP5364HI, MP5364HJ, MP5364HK, MP5364HL, MP5364HM, MP5364HN, MP5364HO, MP5364HP, MP5364HQ, MP5364HR, MP5364HS, MP5364HT, MP5364HU, MP5364HV, MP5364HW, MP5364HX, MP5364HY, MP5364HZ, MP5364IA, MP5364IB, MP5364IC, MP5364ID, MP5364IE, MP5364IF, MP5364IG, MP5364IH, MP5364II, MP5364IJ, MP5364IK, MP5364IL, MP5364IM, MP5364IN, MP5364IO, MP5364IP, MP5364IQ, MP5364IR, MP5364IS, MP5364IT, MP5364IU, MP5364IV, MP5364IW, MP5364IX, MP5364IY, MP5364IZ, MP5364JA, MP5364JB, MP5364JC, MP5364JD, MP5364JE, MP5364JF, MP5364JG, MP5364JH, MP5364JI, MP5364JJ, MP5364JK, MP5364JL, MP5364JM, MP5364JN, MP5364JO, MP5364JP, MP5364JQ, MP5364JR, MP5364JS, MP5364JT, MP5364JU, MP5364JV, MP5364JW, MP5364JX, MP5364JY, MP5364JZ, MP5364KA, MP5364KB, MP5364KC, MP5364KD, MP5364KE, MP5364KF, MP5364KG, MP5364KH, MP5364KI, MP5364KJ, MP5364KL, MP5364KM, MP5364KN, MP5364KO, MP5364KP, MP5364KQ, MP5364KR, MP5364KS, MP5364KT, MP5364KU, MP5364KV, MP5364KW, MP5364KX, MP5364KY, MP5364KZ, MP5364LA, MP5364LB, MP5364LC, MP5364LD, MP5364LE, MP5364LF, MP5364LG, MP5364LH, MP5364LI, MP5364LJ, MP5364LK, MP5364LL, MP5364LM, MP5364LN, MP5364LO, MP5364LP, MP5364LQ, MP5364LR, MP5364LS, MP5364LT, MP5364LU, MP5364LV, MP5364LW, MP5364LX, MP5364LY, MP5364LZ, MP5364MA, MP5364MB, MP5364MC, MP5364MD, MP5364ME, MP5364MF, MP5364MG, MP5364MH, MP5364MI, MP5364MJ, MP5364MK, MP5364ML, MP5364MM, MP5364MN, MP5364MO, MP5364MP, MP5364MQ, MP5364MR, MP5364MS, MP5364MT, MP5364MU, MP5364MV, MP5364MW, MP5364MX, MP5364MY, MP5364MZ, MP5364NA, MP5364NB, MP5364NC, MP5364ND, MP5364NE, MP5364NF, MP5364NG, MP5364NH, MP5364NI, MP5364NJ, MP5364NK, MP5364NL, MP5364NM, MP5364NN, MP5364NO, MP5364NP, MP5364NQ, MP5364NR, MP5364NS, MP5364NT, MP5364NU, MP5364NV, MP5364NW, MP5364NX, MP5364NY, MP5364NZ, MP5364OA, MP5364OB, MP5364OC, MP5364OD, MP5364OE, MP5364OF, MP5364OG, MP5364OH, MP5364OI, MP5364OJ, MP5364OK, MP5364OL, MP5364OM, MP5364ON, MP5364OO, MP5364OP, MP5364OQ, MP5364OR, MP5364OS, MP5364OT, MP5364OU, MP5364OV, MP5364OW, MP5364OX, MP5364OY, MP5364OZ, MP5364PA, MP5364PB, MP5364PC, MP5364PD, MP5364PE, MP5364PF, MP5364PG, MP5364PH, MP5364PI, MP5364PJ, MP5364PK, MP5364PL, MP5364PM, MP5364PN, MP5364PO, MP5364PP, MP5364PQ, MP5364PR, MP5364PS, MP5364PT, MP5364PU, MP5364PV, MP5364PW, MP5364PX, MP5364PY, MP5364PZ, MP5364QA, MP5364QB, MP5364QC, MP5364QD, MP5364QE, MP5364QF, MP5364QG, MP5364QH, MP5364QI, MP5364QJ, MP5364QK, MP5364QL, MP5364QM, MP5364QN, MP5364QO, MP5364QP, MP5364QQ, MP5364QR, MP5364QS, MP5364QT, MP5364QU, MP5364QV, MP5364QW, MP5364QX, MP5364QY, MP5364QZ, MP5364RA, MP5364RB, MP5364RC, MP5364RD, MP5364RE, MP5364RF, MP5364RG, MP5364RH, MP5364RI, MP5364RJ, MP5364RK, MP5364RL, MP5364RM, MP5364RN, MP5364RO, MP53



## COLOR TV CHASSIS AND PARTS

We have just purchased a large quantity of Color TV chassis' and parts which were derailed enroute to the final assembly plant. Chassis' are bulk-packed and intact. Chassis and parts are for 13" and 15" Quasar® 1976 models. We don't have an entire package as of yet, but by adding a few parts from your "junk drawer", you can build a Color TV for around \$100.00. Parts to be added to build a complete set include: picture tube, yoke, purity magnets, tube shields, antenna, 2nd stage hi-voltage boost, and case. All chassis supplied with shop tech manual and any other information we have available. 13" or 15" Color TV chassis only \$49.50 each (includes tuners and controls).

- 13" TV Chassis . . . 6Z60175 . . . \$49.50
- 15" TV Chassis . . . 6Z60174 . . . \$49.50
- Antenna telescope . . . 5MI00419 . . . \$1.50
- TV speaker . . . 6Z60177 . . . \$3.50
- Binding post ass'y. . . 5MI00422 . . . \$1.50
- 15" Tube shield . . . 6Z60339 . . . \$2.00



### TOUCH TONE DATA PHONE

Surplus computer touch-tone phones both new and used, sold as complete units. Buy now at a fraction of the cost. Complete phone and touch-tone pad, head set, micro-circuit boards, logic and op amp power supply (+5V, ±12V), power cord and phone cord etc. Complete unit priced at \$25.00.

Sh. Wt. 7 Lbs. . . . . 6MI60179 . . . . . \$25.00

### MORE ITEMS!

† Big Brute Speakers: MB 10's - \$11.88/pair; 708's - \$10.88/pair; 920's - \$18.88/pair; 420's - \$14.88/pair. † Digital Clock & Radio Alarm Movement by Copal - \$5.88. † Solid State Reverberation System, 12VDC, neg. ground - \$5.00. † K.I.H. Speaker Enclosure - Model 23, less speakers - \$50.00/pair. † G-10 P.C. Board 1/16": 1/1 & 1/10 (state choice) - \$1.50/sq. ft. † 11 Button Touch-Tone Keyboard Switch Set (SPST) - \$2.50. † 0 to 1 Minute Electric Timer - \$2.50. † Viatron System 21 - \$595.00. † Robot Printer - \$160.00. † TIL 305 - 5x7 Dot Matrix Alpha Numeric Display - \$5.00. † Line Cord: 18 ga.; 3 cond; with 1 male plug; 10' lg. - \$1.00/2. † LeeCraft 125V Neon 32, 32R Lights - \$1.00/3. Magnus Organ Close-Out, Model 1700 "as is" - \$29.50 (you repair & save!).

Terms: Add Postage.  
CHARGES WELCOME!  
FREE Catalog with every order.



**B&F ENTERPRISES**  
119 FOSTER STREET  
PEABODY, MASS. 01960  
(617) 532-2323 / 531-5774

CIRCLE NO. 26 ON FREE INFORMATION CARD

# World's Lowest IC Prices

TTL	7100 14	7151 60	LOW POWER SCHOTTKY	74LS00 25	74LS164 150
	7402 14	7157 60		74LS02 25	74LS174 150
	7404 16	7160 75		74LS10 25	74LS175 150
	7410 14	7161 75		74LS73 40	74LS193 150
	7420 14	7163 75		74LS75 50	74LS251 150
	7427 25	7165 80		74LS151 85	74LS253 150
	7438 25	7173 125		74LS153 95	74LS257 150
	7440 14	7174 75		74LS157 150	74LS258 150
	7445 45	7175 75		74LS163 150	
	7447 65	7177 70	CMOS		
	7450 14	7180 80			
	7451 14	7181 150			
	7473 22	7191 100			
	7474 23	7192 70			
	7493 50	7193 70			
	7495 49	7198 100			
	74107 29	9602 50			
	74116 100	9300 75			
	74123 50	9312 70			
	74150 60				
SCHOTTKY					
	74S02 25	74S172 350			
	74S37 40	74S175 150			
	74S85 200	74S181 350			
	74S139 150	74S197 150			
	74S140 50	74S257 150			
	74S155 250				
HIGH SPEED					
	74H00 20	74H51 20			
	74H01 20	74H52 20			
	74H04 20	74H74 40			
	74H10 20	74H103 50			
	74H11 20	74H106 50			
	74H40 20				
LINEARS					
	NE555V 43				
	NE556A 90				
	74LV 30				
	1458V 52				
	566V 125				
	567V 135				
	540L 200				
RAMS					
	2102 150				
PROMS					
	82S23 S123 195				

Order Minimum \$10.00. Add \$1.00 shipping and handling charge per order. California residents add 6% sales tax. All orders shipped promptly.

Order the famous lasis 6 volume Programmed Learning Course "Microcomputer Design is a Snap" for \$99.50 and receive a special \$10.00 credit on any group of IC's.

Satisfaction 100% guaranteed.

C.O.D. Orders:  
Phone (day or night) 408/354-1448

## ELTRON

PO Box 2542 A  
Sunnyvale, CA 94087

CIRCLE NO. 11 ON FREE INFORMATION CARD

INTEL 8080 CPU	\$29.50
2518 HEX 32 BIT SR	\$6.00
2102 11024 BIT RAM	\$2.60
52R0 4K DYNAMIC RAM	\$12.50
5207A UV PROM	\$12.50
MM5203 UV PROM	\$12.50
1702A UV PROM	\$12.50
5204 4K PROM	\$24.95
MINIATURE MULTI TURN TRIM POTS	
100, 500 2K, 5K, 10K, 100K, 200K	\$6.00
\$ .75 each	\$3.20
MULTI TURN TRIM POTS Similar to Bourns	
10K style 3/16"x5/8" x 1 1/4" 50, 100,	
1K, 10K, 50K ohms	
\$1.50 ea.	\$3/4.00
LIGHT ACTIVATED SCR'S	
TO 18, 200V 1A	\$1.75

<b>PRINTED CIRCUIT BOARD</b>	
1 1/2" x 6 1/2" SINGLE SIDED EPOXY BOARD 1 16" track, unpopulated	\$5/2.20
\$50 ea.	
VECTOR BOARD 1" SPACING	
4 5/8" x 6" SHEET 1	\$1.25

<b>4 WATT IR LASER DIODE \$7.95</b>	
2N 3820 P FET	\$ .45
2N 5457 N FET	\$ .45
2N 4891 UJT	\$ .45
TIS 43 UJT	\$ .35
ER 900 TRIGGER DIODES	4/\$1.00
2N 6028 PNP UJT	\$ .65

<b>VERIPAX PC BOARD</b>	
This board is a 106" single sided paper epoxy board, 4 1/2" x 6 1/2" DRILL LED and ETCHED which will hold up to 21 single 14 pin IC's or 8 16 pin LS DIP IC's with buses for power supply connector.	
<b>\$4.00</b>	
MV 5691 YELLOW GREEN	
BIPOLAR LED	\$1.25
RED 2 PHOTO TRANS	\$ .60
MT, YEL LOW, GREEN OR	
AMBER LARGE LED's	ea \$ .70
14 PIN DIP SOCKETS	\$ .25
16 PIN DIP SOCKETS	\$ .25
MOLEX PINS	100/\$1.00
	1000/\$8.00
8 PIN MINI DIP SOCKETS	\$ .25
10 WATT ZENERS 3.9, 4.7, 5.6, 8.2, 12, 15, 18, 22, 100, 150 or 200V	ea \$ .60
1 WATT ZENERS 4.7, 5.6, 10, 12, 15, 18 OR 22V	ea \$ .25

<b>Silicon Power Rectifiers</b>	
PRV 1A 3A 12A 50A 125A	
100 06 14 30 80 370	
200 07 20 35 115 425	
400 11 30 70 140 650	
600 11 30 70 180 850	
800 15 35 90 230 1050	
1000 20 45 110 275 1250	

<b>SILICON SOLAR CELLS</b>	
2 1/2" diameter	
.5V at 500 ma. . . . \$5.00 ea., 6/\$27.50	

<b>REGULATED MODULAR POWER SUPPLIES</b>	
15 VDC AT 100ma	
115VAC INPUT	\$27.95
5VDC AT 1A 115VAC INPUT	\$24.95
12 VDC AT 1A AMP	\$24.95
IN 4148 (IN914)	15/\$1.00

<b>TANTULUM CAPACITORS</b>	
22UF 35V 5 \$1.00	6.8UF 35V 3 \$1.00
47UF 35V 5 \$1.00	22UF 35V 5 \$1.40
68UF 35V 5 \$1.00	33UF 35V 5 \$1.40
1UF 35V 5 \$1.00	301UF 6V 5 \$1.00
3.3UF 35V 4 \$1.00	100UF 35V 5 \$1.50
4.7UF 35V 4 \$1.00	150UF 15V 5 \$1.40
M/001 ALARM CLOCK CHIP \$6.00	

<b>NATIONAL MOS DEVICES</b>	
MM1402 1 1/5	MM5057 2 2/5
MM1403 1 1/5	MM5058 2 7/5
MM1404 1 1/5	MM5060 2 7/5
MM5013 2 5/0	MM5061 2 5/0
MM5016 2 5/0	MM5555 2 5/0
MM5017 2 7/0	MM5556 4 7/5
MM5055 2 2/5	MM5210 1 9/5
MM5056 2 2/5	

<b>TTL IC SERIES</b>		
74L00 - 25	7441 85	74126 60
7400 16	7442 95	74150 100
7401 16	7445 75	74151 80
7402 16	7446 80	74153 79
7403 22	7447 69	74154 105
7404 22	7448 77	74155 100
7405 22	7472 40	74157 75
7406 35	7473 40	74161 100
7407 33	7474 40	74164 105
7408 25	7475 50	74165 105
7409 25	7476 40	74173 95
7410 16	7480 48	74174 120
7411 25	7483 80	74175 95
7412 40	7485 88	74177 100
7413 45	7486 45	74180 100
7414 100	7489 700	74181 240
7416 33	7490 48	74190 111
7417 33	7491 75	74191 110
7420 18	7492 49	74192 80
7425 30	7493 49	74193 90
7426 35	7494 80	74194 125
7427 28	7495 80	74195 74
7430 16	7496 73	74196 110
7432 30	74107 40	75324 1 1/5
7437 30	74121 30	74491 60
7438 30	74123 75	74492 60
7440 18	74125 60	

<b>MINIATURE DIP SWITCHES</b>	
CIS 706-4 Four SPST switches in one mini-plug package	\$1.50
CIS 206-8 Eight SPST switches in a 16 pin DIP package	\$2.55
AY 5 1013 A30K var. cap. per set, 1000 vs. var. UALT	
	\$6.95

<b>ALCO MINIATURE TOGGLE SWITCHES</b>	
MTA 106 SPDT	\$1.20
MTA 206 DPDT	\$1.70

<b>Full Wave Bridges</b>			
PRV	2A	5A	25A
200	95	125	200
400	115	150	300
600	135	175	400

<b>SANKEN AUDIO POWER AMPS</b>	
Si 1010 G 10 WATT	\$ 6.90
Si 1020 G 20 WATT	\$13.95
Si 1050 G 50 WATT	\$24.95

<b>CCD 110 LINEAR 256 XI BIT SELF SCANNING CHARGE COUPLED DEVICE</b>	
DECC 201 100 x 100 CHARGE COUPLED DEVICE	\$99.00
	\$135.00

<b>LINEAR CIRCUITS</b>	
LM 309K 5V 1A REGULATOR	\$1.25
723 40 40V REGULATOR	\$ .50
301 148 Hi Per. Op. Amp	\$ .31

<b>NEGATIVE REG</b>	
/09C Op. Amp	\$ .31
741A or 741C OP AMP	\$ .31
710 COMPARATOR	\$ .35
CA 3047 Hi. Per. Op. Amp	\$ .95

<b>REG TO 220</b>	
340T 5, 6, 8, 12, 15, 18, 24V POS	\$1.50
101 OPER. AMP HI PERFORM.	\$ .75
LM 308 Oper. Amp, Low Power	\$ .95
747 DUAL 741	\$ .65
556 DUAL TIMER	\$1.00

<b>537 PRECISION OP AMP</b>	
LM 3900 QUAD OP AMP	\$ .49
LM 324 QUAD 741	\$1.50
560 PHASE LOCK LOOP	\$2.00
561 PHASE LOCK LOOP	\$2.00
565 PHASE LOCK LOOP	\$1.25
566 FUNCTION GEN	\$1.65

<b>567 TONE DECODER</b>	
LM 1310N FMS STEREO DEMOD	\$2.75
8038 IC VOLTAGE CONT. OSC	\$3.90
LM 370 AGC SOUELCH AMP	\$1.15
555 2MS 2 HR TIMER	\$2.50
553 QUAD TIMER	\$2.50
FCD 810 OPTO ISOLATOR	\$ .80
1458 DUAL OP AMP	\$ .60

<b>LM 380 2W AUDIO AMP</b>	
LM 377 2W Stereo Audio Amp	\$2.50
LM 381 STEREO PREAMP	\$1.50
LM 382 DUAL AUDIO PREAMP	\$1.50
LM 311 HI PER COMPARATOR	\$ .90
LM 319 Dual Hi Speed Comp	\$1.25
LM 339 QUAD COMPARATOR	\$1.50

<b>TRIACS</b>	
PRV 1A 10A 25A 1.5A 6A 35A	
100 40 70 130 40 50 120	
200 70 110 175 60 70 160	
400 110 160 260 100 120 220	
600 170 230 360 150 300	

**WE SHIP OVER 95% OF OUR ORDERS THE DAY WE RECEIVE THEM**



**SOLID STATE SALES**

P.O. BOX 74A  
SOMERVILLE, MASS. 02143 TEL. (617) 547-4005

Terms: FOB Cambridge, Mass.  
Send Check or Money Order.  
Include Postage, Minimum Order \$5.00, COD'S \$20.00

**ARIES** brought you the first calculator kit, and the first digital clock kit... and now brings you three of the most innovative electronic kits ever made. The System 300 Electronic Music Synthesizer kit is the most advanced in the world today, regardless of price. The AR-781 is a space-age beauty for any decor. And the wholly solid state AR-830 does the work of a \$400.00 tape memory unit.

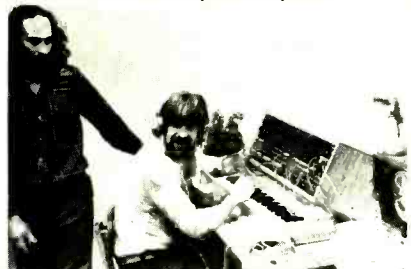

**WARNING**... if you're interested in a music synthesizer, don't make a move until you see our catalog first. It's more like a handbook than a catalog, with hundreds of in-depth photographs and descriptions to explain electronic music principles, and to show equipment to do the job. ARIES now offers a complete complement of modules, keyboards, and cases, matched to the most rigorous professional standards. Starter systems priced as low as \$395.00.

A clear, ruby-red cylinder shows off all six digits of this modern calendar clock. Easy-to-read numbers show the hours, minutes, and seconds, as well as the month and day every ten seconds.



Red LED 7-segment numerals are 0.33" high, in a sturdy cylinder 2-1/2" in diameter and 4-3/4" long, with finished hardwood ends. Time and calendar are controlled by 60 Hz line frequency, with a 12-month movement. Separate time and calendar adjustments. Includes all the components, PC boards, housing, and instructions. Shipping weight 2 lbs. **AR-781 Clock Kit** ..... \$34.50

Add finger-touch operation to your old-fashioned dial telephone with an **ARIES AR-830 Automatic Digital Telephone Dialer**. This has the same layout and convenience as Ma Bell, plus other features she doesn't offer yet. For instance... AR-830 always remembers the last number you dialed, in case the line was busy and you want to try again later. Not only that, but the Dialer's memory can store as many as ten of your favorite numbers for one-touch dialing. AR-830 uses standard dialing and muting contacts; consult local tariffs before connecting. Sh. wt. 2 lbs. **AR-830 Dialer Kit** ..... \$69.50



**ARIES INC.**  
119 Foster Street  
Peabody, Mass., 01960  
(617) 532-0450

CIRCLE NO. 9 ON FREE INFORMATION CARD

## TAPE AND RECORDERS

RENT 4-Track open reel tapes—free brochure. Stereo-Parti, P.O. Box 7, Fulton, CA 95401.

1930-1962 Radio Programs. Reels, \$1.00 Hour! Cassettes, \$1.00 Show!... Mammoth Catalog. \$1.25. AM Treasures. Box 192PE, Babylon, N.Y. 11702.

**RECORDS—TAPES!** Discounts to 73%; all labels; no purchase obligations; newsletter; discount dividend certificates; 100% guarantees. Free details. Discount Music Club, 650 Main St., Dept 5-1076, New Rochelle, New York, N.Y. 10801.

**RECORDING TAPE** first quality, name brands, huge discounts, get details. Electronic Digits, P.O. Box 09362E, Milwaukee, Wis. 53209.

## GOVERNMENT SURPLUS

**MANUALS** for Govt Surplus radios, test sets, scopes. List 50 cents (coin). Books, 7218 Roanne Drive, Washington, D.C. 20021.

**JEEPS, TRUCKS.** Typically From \$52.40... Automobiles, Boats, Motorcycles, Airplanes, Oscilloscopes, Tools, Clothing, Sports, Camping, Photographic, Electronics Equipment... 200,000 Bid Bargains Nationwide Direct From Government... Low as 2 cents on Dollar! Surplus Catalog and Sales Directory \$1.00 (refundable first order). National Surplus Center, 240 Eastcass-PEL, Joliet, IL 60432.

**GOVERNMENT SURPLUS.** Buy in your area. How, Where. Send \$2.00. Surplus, 30177-PE Headquarters Building, Washington, D.C. 20014.

## BOOKS AND MAGAZINES

**FREE book prophet Elijah** coming before Christ. Wonderful bible evidence. Megiddo Mission, Dept. 64, 481 Thurston Rd., Rochester, N.Y. 14619.

**THE AUDIO AMATEUR**—A quarterly publication for the serious audio constructor. Free prospectus. The Audio Amateur, Box 176Z, Peterborough, N.H. 03458.

**CRIMEFIGHTERS! SHOPLIFTING! LOCKPICKING! DE-BUGGING!** All 3 books for only \$5.00. Don-Q, 548-PE, Seattle, Washington 98111.

## FREE! CONSUMER SERVICE DIVISION CATALOG

Includes a wide variety of products associated with the special interests of readers of Ziff-Davis magazines—Psychology Today, Popular Photography, Stereo Review, Popular Electronics, Boating, Flying, Car and Driver, Cycle, Skiing.

Send for your free catalog today.  
Consumer Service Div., 595 Broadway, N.Y. N.Y. 10012

**FREE CATALOG.** Aviation and Space Books. Aero Publishers, 329PE West Aviation, Fallbrook, California 92028.

**DC REGULATED SUPPLIES** — \$2.00. **OPERATIONAL AMPLIFIERS** — \$2.00. Design, build, use, and troubleshoot through understanding. An engineer authors. Technical Publications Department, Jaquish Enterprises, Box 875, Troy, NY 12181.

## REAL ESTATE

**BIG...FREE...FALL CATALOG!** 256 pages! Over 2,600 top values coast to coast! **UNITED FARM AGENCY.** 612-EP, West 47th, Kansas City, MO 64112.

# EDLIE'S BARGAIN BONANZA ONLY HIGHEST QUALITY PRODUCTS



### SURPLUS TUBES

All guaranteed for 1 full year.

### ANY 3 FOR \$1.49

Acquired from U.S. Defense depots or removed from equipment (new and used). These are laboratory tested and guaranteed for one full year. Most are of such standard makes as RCA, GE, etc.

3A3	6AQ7	6CG7	6T8
3BN6	6AT6	6CM7	6W4
3DG4	6AU6	6DE4	8SN7
3KT6	6AV6	6DR7	10EW7
3Q4	6AX4	6DW4	12AE7
3S4	6AX5	6EB8	12AL5
4BC5	6AY3	6EM7	12AU7
4BN6	6BA6	6GF7	12AV6
4BU8	6BG6	6GH8	12BH7
5V6	6BJ8	6K6	18FW6
6AF4	6BQ6	6K11	25L6
6AG5	6BZ6	6LB6	35EH5
6AL5	6CB6	6SN7	36AM3

### (GP147) 4 lb. GRAB BAG SPECIAL

Full of exotic and exciting electronics parts

### (GP155) TUBE BONANZA!

20 asst. popular tubes, untested.

### (GP142) 50 PRECISION RESISTORS

All 1/2w, 1/4w and 1w. low and high ohmages.

### (GP150) POWER TRANSFORMER

Primary 117 volts. Sec. 1-11.1 volts. Sec.2 17.7 volts; Sec.3 15.9 volts; Sec.4 27.7 volts. Each winding approx. 750 mils. Size 2 1/4" H x 2" D x 3/8" mounting centers. \$1.95

### (GP175) 70 1/2w CARBON RESISTORS

Asst. values. Some 5%.

### (GP154) 150 CUT LEAD RESISTORS

Carbon, all leads long enough for soldering.

### (GP149) 20 POLYSTYRENE TOP GRADE CAPACITORS

\$1.00

### (GP132) 20 DUAL POTS

\$1.00



24V. C.T. FILAMENT TRANSFORMER 1/2A. WITH 150V. TAP.

### (GP202) 99c ea 6 for \$4.99

### MONEY BACK GUARANTEE

Terms: Minimum order \$5.00. Include postage. Either full payment with order or 20% deposit, balance C.O.D.

### BONUS FREE CAPACITOR KIT With Every \$5 Purchase

### WRITE FOR FREE 1976 VALUE PACKED CATALOG

Listing thousands of components, tubes, transistors, IC's, kits, test equipment.

## THIS MONTH'S SPECIALS!

TTL			
<input type="checkbox"/> 7400	18c	<input type="checkbox"/> 7446	80c
<input type="checkbox"/> 7401	18c	<input type="checkbox"/> 7447	80c
<input type="checkbox"/> 7402	22c	<input type="checkbox"/> 7448	80c
<input type="checkbox"/> 7403	23c	<input type="checkbox"/> 7473	49c
<input type="checkbox"/> 7404	23c	<input type="checkbox"/> 7474	49c
<input type="checkbox"/> 7405	23c	<input type="checkbox"/> 7475	85c
<input type="checkbox"/> 7406	23c	<input type="checkbox"/> 747	53c
<input type="checkbox"/> 7410	23c	<input type="checkbox"/> 7490	79c
<input type="checkbox"/> 7411	27c	<input type="checkbox"/> 7492	79c
<input type="checkbox"/> 7413	40c	<input type="checkbox"/> 7493	69c
<input type="checkbox"/> 7420	23c	<input type="checkbox"/> 7495	79c
<input type="checkbox"/> 7430	23c	<input type="checkbox"/> 74121	57c
<input type="checkbox"/> 7440	30c	<input type="checkbox"/> 74122	57c
<input type="checkbox"/> 7442	\$1.12	<input type="checkbox"/> 74123	67c

### LINEARS

<input type="checkbox"/> LM309K	5v 1a. reg.	\$1.15
<input type="checkbox"/> 555	Timer	75c
<input type="checkbox"/> 556	Dual 555	\$1.00
<input type="checkbox"/> 566	Function gen.	\$1.75
<input type="checkbox"/> 567	Tone decoder	\$1.95
<input type="checkbox"/> 741	comp. op amp	39c
<input type="checkbox"/> 2513	Char. gen.	\$5.95
<input type="checkbox"/> 8038	volt cont osc	\$4.25

### CLOCK CHIPS WITH DATA

<input type="checkbox"/> (MM5314)	6 dig clock	\$4.95
<input type="checkbox"/> CT7001	Alarm & Date	\$5.95

### LED'S

<input type="checkbox"/> (GP223)	10 Asst LEDs	\$1.00
<input type="checkbox"/> (GP242)	5 Jumbo Green LEDs	\$1.00
<input type="checkbox"/> (GP242)	5 Med Yellow LEDs	\$1.00
<input type="checkbox"/> (GP001)	5 Jumbo Red LEDs	\$1.00
<input type="checkbox"/> (GP011)	5 Med Red LEDs	\$1.00
<input type="checkbox"/> (GP012)	5 Mini Red LEDs	\$1.00
<input type="checkbox"/> (GP293)	DL707 (equiv.) 7 seg red LED, 3" char., comm anode	\$1.50
<input type="checkbox"/> (GP006)	DL 704 (equiv.) same as DL707 except comm cath	\$1.50
<input type="checkbox"/> (GP007)	DL747 7 seg red LED, 6" char., comm anode	\$2.25
<input type="checkbox"/> (GP013)	MAN 5 (equiv.) 7 seg green LED, 27 char. comm. anode	\$1.49

### IC BREADBOARDS & TERMINALS

Boards have .042 holes. Made of 1/16" polyester glass.

<input type="checkbox"/> (BB663)	3"x4"	\$1.16
<input type="checkbox"/> (BB664)	3"x6"	\$1.34
<input type="checkbox"/> (BB665)	4"x6"	\$1.65
<input type="checkbox"/> (BB666)	4"x8"	\$2.12

Push-in terminals

<input type="checkbox"/> (GP6601-20)	pkg	20/90c
<input type="checkbox"/> (GP6601-100)	pkg	100/\$2.98

Push-in flanged pins

<input type="checkbox"/> (BB6602-20)	pkg	20/90c
<input type="checkbox"/> (BB6602-100)	pkg	100/\$2.98

Push-in flea clips

<input type="checkbox"/> (BB6603-20)	pkg	20/90c
<input type="checkbox"/> (BB6603-100)	pkg	100/\$2.98

(B008) 14 pin DIP sockets 3 for \$1

(GP1104) IC REMOVAL AND INSERTION TOOL \$4.95

\*"Pul-n-seric" extracts and inserts ICs without damage.



**REEL RELAYS**  
 (GP203) SPST, 12V, 1000 ohms coil. Price 79c

Prices are subject to change without notice.

EDLIE ELECTRONICS, INC. 2700-GP HEMPSTEAD TPKE., LEVITTOWN, N.Y. 11756

SOLID STATE

**TECHNOLOGY KIT**

- FOR THE EXPERIMENTER WITH TASTE FOR "STATE OF THE ART" PRODUCTS
- COMPLETE SPECIFICATIONS ARE PRINTED ON THE BACK OF EACH TECHNOLOGY KIT

FTK0020

FTK0020

FTK0011

PN FTK0020

SOLID STATE  
**TECHNOLOGY**

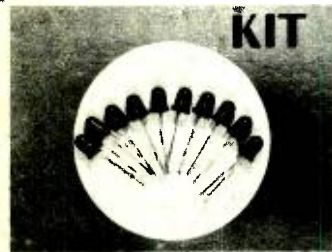

TEN RED LED LAMPS

TECHNOLOGY BY

**FAIRCHILD**

4001 MIRANDA AVENUE • PALO ALTO, CA 94304

CARD FRONT

The FTK0020 is a red light emitting diode (LED) array kit. The LED device provides an average beam angle of 120 degrees with a peak angle of 60 degrees. The beam angle is in the 870 nm range. Typical forward voltage is 1.7 V. An anti-voltage is required. The forward voltage may be used to check the device. Some LEDs are current up rated devices. A series resistor must be used to limit the maximum current to the absolute maximum rating of the device using the formula:

$$R = \frac{V_{supply} - V_{forward}}{I_{desired}}$$

- SOLID STATE - NO REPLACEMENT REQUIRED
- NO BATTERIES REQUIRED
- HIGH ON/OFF CONTRAST
- BATTERY LEAKS FOR 2000 HOURS AND BRIGHT ANGLES FINDING
- MEETS STANDARD SOCIETY AND COMELEC RULES
- BUILT IN 2000 HOURS OF LIFE WITH NO CYCLING PROBLEMS
- HIGH TEMPERATURE SOLDER ENCASULATION WITH FINISH REVEAL
- ENVIRONMENTAL TEMPERATURES
- LOW POWER CONSUMPTION MEANS COMPATIBILITY

**ABSOLUTE MAXIMUM RATINGS**

Maximum Temperature and Humidity	125 C
Storage Temperature	180 C
Pin Temperature (Leadwire) 3 in	260 C
Relative Humidity at 85 C	85%
Maximum Power Dissipation	100 mW
Total Dissipation	4.0 mW
Derate from 100 C	
Maximum Voltage and Current	
V <sub>f</sub> Reverse Voltage	3.0 V
I <sub>f</sub> Forward DC Current	80 mA
I <sub>sm</sub> Forward Peak Current (10 μs pulse)	1.0 A

**PIN CONNECTIONS**

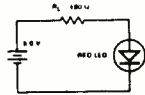

TYPICAL APPLICATION

PN FTK0011

SOLID STATE  
**TECHNOLOGY**

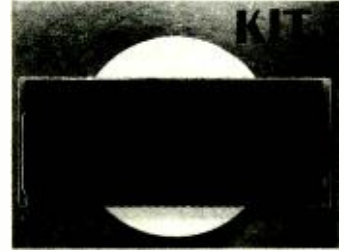

24 HOUR, 0.8" HIGH CLOCK DISPLAY

TECHNOLOGY BY

**FAIRCHILD**

4001 MIRANDA AVENUE • PALO ALTO, CA 94304

CARD FRONT

DIGITS

FTK0001	0.5" High Common Cathode Digit	\$1.00
FTK0002	0.5" High Common Anode Digit	1.00
FTK0003	.357" High Common Cathode Digit	.75
FTK0004	0.8" High Common Cathode Digit	2.00
FTK0005	0.8" High Common Anode Digit	2.00

0.8" HIGH DISPLAY ARRAYS

FTK0010	12 Hour, 3½ Digit Clock Display	7.00
FTK0011	24 Hour, 4 Digit Clock Display	8.00

LED LAMPS

FTK0020	10 Red LED Lamps	1.00
FTK0021	5 Mixed Colored LED Lamps	1.00
FTK0022	10 LED Mounting Clips	1.00
FTK0023	5 Three Piece LED Mounting Adapters	1.00

PHOTO TRANSISTORS

FTK0030	5 Flat Lens Photo Transistors	1.00
FTK0031	5 Round Lens Photo Transistors	1.00
FTK0032	3 Flat Lens Photo Darlington	1.00
FTK0033	3 Round Lens Photo Darlington	1.00

CARD BACK

PHOTO ARRAYS

FTK0040	9-Element Tape Reader Array	16.00
FTK0041	12-Element Card Reader Array	24.00
FTK0042	Reflective Opto Coupler	4.00

COUPLERS

FTK0050	3 General Purpose Opto Couplers	1.00
FTK0051	Darlington Opto Coupler	1.00

MOS CLOCK CIRCUITS

FTK0400	Digital Clock/Calendar Circuit (FCM7001)	7.00
FTK0401	Digital Clock/Calendar with BCD Outputs (FCM7002)	7.00
FTK0402	Direct Drive Digital Clock Circuit with AC Output (FCM3817A)	5.00
FTK0403	Direct Drive Digital Clock Circuit with DC Output (FCM3817D)	5.00
FTK0405	Direct Drive Digital Clock/Calendar Circuit (FCM7015)	6.00

KITS

FTK0106	Automobile Clock Kit	40.00
---------	----------------------	-------

• THESE PRODUCTS ARE PACKAGED FOR OUT-STANDING WALL DISPLAY APPEARANCE

• DEALER'S AND WHOLESALER'S INQUIRIES INVITED—PRICE LIST AVAILABLE.

• FULL **FAIRCHILD** PRODUCT LINE TO FOLLOW

• BUY WITH PRIDE THE PRODUCTS BUILT BY THE INDUSTRY'S LEADER — **FAIRCHILD**

Satisfaction Guaranteed. \$5.00 Min. Order. U.S. Funds. California Residents — Add 6% Sales Tax. Send a 13c Stamp (postage) for a FREE 1976 Catalog.

*JAMES*

1021 HOWARD STREET  
SAN CARLOS, CA 94070  
PHONE ORDERS — (415) 592-8097

## IMSAI & ALTAIR OWNERS!

All IMSAI 8080 Computer

**Boards Completely Plug-Compatible With Altair 8800**

Interchangeable MPU, Memory and I/O Boards. Full IMSAI 8080/Altair 8800 Bus Compatibility. No Hardware Modifications Required. Just Plug In!

Part #	Description	Kit	Assembled
MPU-A	8080 microprocessor board...	\$190	\$350
RAM 4A-4	4K static RAM board .....	139	279
PROM 4-4	4K bytes EPROM board .....	399	579
EXT	Extender board .....	39	49
PIC-8	Priority int/clock board .....	125	238
PIO 4-1	One-port parallel I/O board .....	93	140
PIO 4-4	Four-port parallel I/O board .....	156	299
SIO 2-1	One-port serial I/O board .....	125	235
SIO 2-2	Two-port serial I/O board .....	156	299
UCRI-1	Cassette recorder I/O board .....	59	99

### IMSAI 8080 Computer

Basic computer includes front panel/control board, 28 amp power supply, MPU board, 6-slot expander board with 2 edge connectors, cabinet, assembler software and complete documentation . . . \$599 Kit, \$931 Assembled.

### COMPLETE DOCUMENTATION

An Introduction To Microcomputers, Vol. I & II .....	\$12.00
IMSAI 8080 User's Manual .....	50.00
INTEL 8080 Assembly Language Manual .....	12.00
INTEL 8080 User's Manual .....	7.00
The T.I. TTL Handbook .....	10.00
Supplement to T.I. TTL Handbook .....	5.00
My Computer Likes Me When I Speak In BASIC .....	3.50
BASIC-PLUS Language Manual .....	17.00
8080 Programming for Logic Design .....	12.00
Pinout Handbook, 54/7400 Series .....	5.00
What To Do After You Hit RETURN (Computer Games) .....	11.00

### SEND \$1 FOR NEW IMSAI 8080

**ILLUSTRATED 16-PAGE CATALOG TODAY!** TERMS: Check, money order, BankAmericard, Master Charge (include all embossed data on card). 25% non-refundable deposit on C.O.D. 25% cancellation charge on all orders. California residents add 6% sales tax. Prices, terms and specifications subject to change without notice.

## IMSAI

IMS Associates, Inc.

14860 Wicks Blvd., San Leandro, CA 94577  
Phone: (415) 483-2093

## BUSINESS OPPORTUNITIES

I MADE \$40,000.00 Year by Mailorder! Helped others make money! Free Proof. Torrey, Box 318-NN, Ypsilanti, Michigan 48197.

FREE CATALOGS. Repair air conditioning, refrigeration, Tools, supplies, full instructions. Doolin, 2016 Canton, Dallas, Texas 75201.

MAILORDER MILLIONAIRE helps beginners make \$500 weekly. Free report reveals secret plan! Executive (1K10), 333 North Michigan, Chicago 60601.

PIANO TUNING LEARNED QUICKLY AT HOME! Musical knowledge unnecessary. Free Information. Empire School, Box 450327, Miami 33145.

GET RICH with Secret Law that smashes debts and brings you \$500 to \$5 Million cash. Free report! Credit 4K10, 333 North Michigan, Chicago 60601.

## HIGHLY PROFITABLE ONE-MAN ELECTRONIC FACTORY

Investment unnecessary, knowledge not required, sales handled by professionals. Postcard brings facts about this unusual opportunity. Write today! Barta-DJ, Box 248, Walnut Creek, CA 94597.

FREE SECRET BOOK "2042 UNIQUE. Proven Enterprises" Fabulous "Little Knowns". Work home! Haylings-B. Carlsbad, Calif. 92008.

HOW TO MAKE \$2,000 WEEKLY at home using other people's money. Guaranteed. Free Details. Richlieu, Box 25277, Dept. F10, Houston, Texas 77005.

FREE DETAILS on how to borrow \$300-\$3,000 entirely by mail. Write Postal Finance, Dept. 613-07, 6018 Maple, Omaha, Nebraska 68104.

CAMPUS AUDIO DEALERS WANTED. We need people to help sell our high quality audio components at huge discounts. Sell in your area or on campus. Earn big bucks, no capital outlay required, no experience necessary. For complete information write to: ABCO, Dept. CD, 915 Grand Avenue, New Haven, Conn. 06511.

EARN \$1000 showing our high quality aluminum, vinyl or steel siding on your home. Free Details. ALUMINUM INDUSTRIES, Dept. PE-A6, Little Rock, AR 72215.

## ABOUT YOUR SUBSCRIPTION

Your subscription to POPULAR ELECTRONICS is maintained on one of the world's most modern, efficient computer systems, and if you're like 99% of our subscribers, you'll never have any reason to complain about your subscription service.

We have found that when complaints do arise, the majority of them occur because people have written their names or addresses differently at different times. For example, if your subscription were listed under "William Jones, Cedar Lane, Middletown, Arizona," and you were to renew it as "Bill Jones, Cedar Lane, Middletown, Arizona," our computer would think that two separate subscriptions were involved, and it would start sending you two copies of POPULAR ELECTRONICS each month. Other examples of combinations of names that would confuse the computer would include: John Henry Smith and Henry Smith; and Mrs. Joseph Jones and Mary Jones. Minor differences in addresses can also lead to difficulties. For example, to the computer, 100 Second St. is not the same as 100 2nd St.

So, please, when you write us about your subscription, be sure to enclose the mailing label from the cover of the magazine—or else copy your name and address exactly as they appear on the mailing label. This will greatly reduce any chance of error, and we will be able to service your request much more quickly.

## STEREO TEST RECORD

FOR HOME AND LABORATORY USE

Announcing the **NEW STANDARD** in Stereo Testing!

The All-New Model SR12 STEREO TEST RECORD

The most complete... most sophisticated... most versatile Test Disc available today... For Just \$5<sup>98</sup>!

Whether you're an avid audiophile, a casual listener or a professional technician . . . the new MODEL SR12 will be the most important disc in your entire collection.

MODEL SR12 has been produced by Stereo Review Magazine for music lovers who want immediate answers to questions about the performance of their stereo systems and how to get the best possible sound reproduction.

It is the most complete test record of its kind — containing the widest range of checks ever included on one test disc.

### Make these important stereo checks BY EAR... (no test instruments required)

- ▶ Frequency response—a direct warble-tone check of nineteen sections of the frequency spectrum, from 20 to 20,840 Hz, which will pinpoint any frequency response defects in your system.
- ▶ Separation—an ingenious test which indicates whether you have adequate separation for good stereo.
- ▶ Cartridge tracking—the most sophisticated tests ever devised for checking the performance of your cartridge, stylus and tone arm.
- ▶ Channel balance—two broad-band, random-noise signals which permit you to eliminate any imbalances originating in cartridge, amplifier, speakers or room acoustics.
- ▶ Hum and rumble—foolproof tests that help you evaluate the actual audible levels of rumble and hum in your system.
- ▶ Flutter—a sensitive "musical" test to check whether your turntable's flutter is low, moderate, or high.

**PLUS!** ● Cartridge and Speaker Phasing ● Anti-Skating Adjustment ● "Gun Shot Test" for Stereo Spread ● Multi-purpose Musician's "A" ● Equal-tempered Chromatic Octave ● Guitar-tuning Tones.

Attention Professionals . . . . . Model SR12 is also designed to be used as a highly efficient design and measurement tool. Tests below have been controlled to laboratory tolerances—affording accurate numerical evaluation when used with oscilloscope, chart recorder, output meter, intermodulation-distortion meter and flutter meter.

- 1,000-Hz square waves to test transient and high-frequency response of phono pickups.
- 500 to 20,000 Hz frequency-response sweep.
- Sine-wave tone-bursts to test transient response of pickup.
- Intermodulation test using simultaneous 400-Hz and 4,000-Hz signals.
- Intermodulation sweep to show distortion caused by excessive resonances in tone arm and cartridge.
- 1,000-Hz reference tones to determine groove velocity.
- 3,000-Hz tone for flutter and speed tests.

Sample waveforms—illustrating both accurate and faulty responses are provided in the Instruction Manual for comparison with the patterns appearing on your own oscilloscope screen.

FREE—An informative manual which includes charts, tables and diagrams.

CHARGE YOUR ORDER TO YOUR AMERICAN EXPRESS, BANKAMERICARD, MASTER CHARGE OR DINERS CLUB ACCOUNT.

Ziff Davis Service Division, Dept. R, 595 Broadway, N.Y., N.Y. 10012.

Please send the SR12 Stereo Test Record @ \$5.98, postpaid (\$8 outside U.S.A.).

Enclosed is \$\_\_\_\_\_ (Residents of Calif., Col., Fla., Ill., Mich., Mo., N.Y. State, D.C. and Tex. add applicable sales tax.)

CHARGE:  BankAmericard  Master Charge  American Express  Diners Club

Account # \_\_\_\_\_ Exp. Date \_\_\_\_\_

Master Charge Interbank # \_\_\_\_\_ (4 numbers over your name)

Signature \_\_\_\_\_

Print Name \_\_\_\_\_

Address \_\_\_\_\_

City \_\_\_\_\_

State \_\_\_\_\_

Zip \_\_\_\_\_



PE-106

**PLANS AND KITS**

**AMAZING ELECTRONIC PRODUCTS**

LASERS SUPER POWERED RIFLE. PISTOL. POCKET. SEE IN DARK. PYRO TECHNICAL DE BUGGING. UNCRAMBLERS. GIANT TESLA. STUNWAND. TV DISRUPTER. ENERGY PRODUCING. SCIENTIFIC DETECTION. ELECTRIFYING. CHEMICAL ULTRASONIC. CB. AFRO. AUTO AND MECH DEVICES. HUNDREDS MORE. ALL NEW PLUS INFO UNLTD PARTS SERVICE

**INFORMATION unlimited**

CATALOG \$1 Box 626 Lord Jeffrey Pz • Amherst, N.H. 03031

FREE KIT Catalog contains Test and Experimenter's Equipment. Dage Scientific Instruments, Box 1054P, Livermore, CA 94550

"CBers!" "TREMENDOUS POWER INCREASE" using NEW higher 46" all-directional CB Antenna!!! Plan \$2. (2/53). Astrobeam-3. 704 Edwards, Visalia, CA 93277

SCIENCE supplies and kits, write for free catalog: Schubert & Son, Box 214848-F, Sacramento, CA 95821.

NEED SECOND INCOME? There's money in rejuvenating picture tubes. Color & BW. Amazing results. Build rejuvenator costing \$250 to \$450 from spare parts around shop. Detail plans & instructions \$6.90. Discount Electronics, Box 1535, Pinellas Park, Fla. 33565

**BURGLAR ALARMS**

DIALING Unit automatically calls police. Immediate delivery \$29.95. Free literature. S&S Systems, 5619-C St. John, Kansas City, MO 64123. (816) 483-4612

**INVENTIONS WANTED**

INVENTORS: Manufacturers Need New Products. Free "Recommended Procedure," by a creative fee-based invention service company Washington Inventors Service, 422-T Washington Building, Washington, D. C. 20005

**INVENTORS**

**RECOGNITION...FINANCIAL REWARD...OR CREDIT FOR "INVENTING IT FIRST" MAY BE YOURS!**

If you have an idea for a new product, or a way to make an old product better, contact us, "the idea people" We'll develop your idea, introduce it to industry, negotiate for cash sale or royalty licensing. Write now without cost or obligation for free information. Fees are charged only for contracted services. So send for your FREE "Inventor's Kit." It has important Marketing Information, a special "Invention Record Form" and a Directory of 500 Corporations Seeking New Products.

**RAYMOND LEE ORGANIZATION**  
230 Park Avenue North, New York, NY 10017

At no cost or obligation, please rush my FREE "Inventor's Kit No. A-112"

Name \_\_\_\_\_ Please Print  
Address \_\_\_\_\_  
City \_\_\_\_\_ State \_\_\_\_\_ Zip \_\_\_\_\_

FREE PAMPHLET "Tips on Marketing Your Invention" from an experienced fee-based invention service company Write United States Inventors Service Company, Dept. T, 1435 G Street NW, Washington, D. C. 20005.

**HYPNOTISM**

SLEEP learning. Hypnotic method. 92% effective. Details free. ASR Foundation, Box 23429EG, Fort Lauderdale, Florida 33307.

FREE Hypnotism, Self-Hypnosis, Sleep Learning Catalog! Drawer H400, Ruidoso, New Mexico 88345.

AMAZING self-hypnosis record releases fantastic mental power. Instant results! Free trial. Write: Forum (AA10), 333 North Michigan, Chicago 60601.

**WANTED**

GOLD, Silver, Platinum, Mercury wanted. Highest prices paid by refinery. Ores assayed. Free circular. Mercury Terminal, Norwood, MA 02062.

OCTOBER 1976

**HIGH FIDELITY**

DIAMOND NEEDLES and Stereo Cartridges at Discount prices for Shure, Pickering, Stanton, Empire, Grado and ADC. Send for free catalog LYLE CARTRIDGES, Dept. P, Box 69, Kensington Station, Brooklyn, New York 11218

**TREASURE FINDERS**

TREASURE FINDER locates buried gold, silver, coins, treasures. 6 powerful models. Instant financing available. Write or call for free catalog. Phone (713) 682-2728 day or night. Relco, Dept. AA20, Box 10839, Houston, Texas 77018.

DISCOVER true treasure hunting with world-famous deep-detecting mineral-metal detectors from White's! Locate gold, silver, rings, coins, artifacts and more! Sold, serviced, warehoused world wide. Priced from \$79.50. Free Catalog! White's Electronics, Dept. PD6X, 1101 Pleasant Valley Rd., Sweet Home, OR 97386.

**TUBES**

RADIO & TV Tubes—36 cents each. Send for free Catalog. Cornell, 4213 University, San Diego, Calif. 92105

TUBES receiving, factory boxed, low prices, free price list. Transletronic, Inc., 1365 39th Street, Brooklyn, N.Y. 11218A, Telephone: 212-633-2800

TUBES: "Oldies". Latest Supplies, components, schematics. Catalog Free (stamp appreciated) Steinmetz, 7519-PE Maplewood, Hammond, Ind. 46324.

**DO-IT-YOURSELF**

MODULAR TELEPHONES now available. Sets and components, compatible with Western Electric concept. Catalog 50 cents. Box 1654W, Costa Mesa, California 92626

CONTROL Speed of DC Motors—Amazing Module — 1-3 8" square x 1-1/2" High input — 24 VDC at 2 Amps — \$9.95. LM Industries, 772 E 53rd St., Brooklyn, N.Y. 11203.

**ADVANCED MICROCOMPUTER PRODUCTS**

**NEW PRODUCTS**

- NEW MOS/LSI TV GAME CHIP \$1.49  
GI AY3 6900 1 in Stock  
6 TV Games on a single IC  
Unit Qty 39.95  
Ov (15) 33.95  
Ov (10) 29.95
- TV Kit 1 PCB, Chip Instructions 42.95  
Video composite output
- TV Kit 2 PCB, Chip, Switches 59.95  
Caps, pots, speaker, crystal, etc. and all parts required for video output, instructions
- TV Kit 3 The ultimate in TV 99.95  
Games, inc. chassis, RF modulator, battery operation, parts assemblies
- FUNCTION GENERATOR KIT 27.50  
PCB, function chip, instructions, and external components
- MULTIFLEX KIT 50.00  
PCB, instructions plus  
GI AY5 9100 push button tester  
AY5 9200 reprography dialer  
AY5 9400 Multi-Flex gen.  
AY5 9500 CMOS clock gen.
- TOUCHTONE CONVERTER 554.95  
Converts dial phone to touchtone completely assembly
- ALTAIR/MSAI COMPATIBLE 8K LOW POWER STATIC RAM MODULE  
All the latest features at affordable prices  
Includes 500 ns access time requiring no wait states, fully buffered, memory write protect, battery back up, addressable on 1K boundaries to 0.8K, 1.9K, 2.1K etc., non-injection circuitry, chip switch address selection  
Serial Introductory Price Only \$259.00  
JUST LIKE THE OTHER GUYS BUT LESS MONEY!!
- AMI EVK 98 6800 based Microcomputer Kit \$149.00  
Expandable to upgrade EIPROM programming, 1024 Bytes RAM, 2048 Bytes R ROM, 2048 Bytes EPROM, lines, TVT, selectable DMA, SV, Kit contains PCBs 6800, 6850, 6820, (2) 6830, (4) 6810, 1 operating manual and complete instructions Also Available: 1 Toy Basic for 6800 Coming Soon 16K RAM Add on memory Write for More Details 79.95
- 8080A Chip Set Special 79.95  
1 AMI 8080A  
32 AMD 911 02 APC (500ms) Rams

Note: our products have been designed by people like you. If you have any ideas, drop us a line and we will show you how to participate.

**ADVANCED MICROCOMPUTER PRODUCTS**

**IC MARKETPLACE**

<b>MICROPROCESSORS</b>	<b>GENERAL INSTRUMENTS</b>	<b>PERIPHERAL CIRCUITS</b>	<b>QUAD/DUALS/SPECIALS</b>
AMD 8080A \$24.95 AY5 2901 31.00 AMI 1600 24.95 GI CP1600 59.95	AY5 1013A Uart \$ 5.25 AY5 1203 Clockchip 9.95 AY5 2376 Keyboard encoder 15.00 RD3-2513 Character Generator 10.95	75450 thru 453 \$ .49 1488 1.45 1489A 1.45 74LS138 1.50 8820N 1.95 8830N 1.95 8831 1.95 8832 1.95 8126B 2.95 9601PC 99 9602PC 1.25 9614PC 1.95 9615PC 1.95 9616PC 4.25 9617PC 4.25 9620PC 3.50 9621PC 3.50 75107N 2.25 75108N 2.25 75109N 2.05 75110N 2.05 75207N 2.05 75208N 2.05	RC1458 CN .89 RC1556 CN .99 RC3403AD 2.30 RC4131 CN .99 RC4136 D 1.99 RC4558 CN .99 RC4151 CN 6.50 XR 2556CP 2.95 XR 2240CP 2.95 XR 1310P 2.95 XR 2206CP 3.95 XR 2207CP 3.75 XR 1870P 2.95
<b>6800 SUPPORT DEVICES</b>	<b>MEMORY DEPARTMENT</b>	<b>SENSE AMPS</b>	<b>CLOCK DRIVERS</b>
S6800 Modern \$15.95 S6801 P/A 11.00 S6810 1 RAM 5.25 S6850 ACIA 9.95 S2350 USRT 7.95 S1883 UART 5.00 S6834-1 EPROM 22.95 S6800 Prog. Manual 15.00 S6800 Hardware Manual 15.00	2102APC (500ns.) \$ 1.70 21L02APC (500ns.) 1.89 2112 PC 3.90 1702A 10.90 DM8599 4.75 P3101 3.25 4402 (4K Static) 12.95 4200 (4K Static) 13.95 AMD9130 13.95 AMD9140 13.95	7520N \$2.50 75234N 2.10 DH3725CN 2.50	74C196 1.95 74C200 2.95 74C201 2.95 74C202 2.95 74C203 2.95 74C204 2.95 74C205 2.95 74C206 2.95 74C207 2.95 74C208 2.95 74C209 2.95 74C210 2.95 74C211 2.95 74C212 2.95 74C213 2.95 74C214 2.95 74C215 2.95 74C216 2.95 74C217 2.95 74C218 2.95 74C219 2.95 74C220 2.95 74C221 2.95 74C222 2.95 74C223 2.95 74C224 2.95 74C225 2.95 74C226 2.95 74C227 2.95 74C228 2.95 74C229 2.95 74C230 2.95 74C231 2.95 74C232 2.95 74C233 2.95 74C234 2.95 74C235 2.95 74C236 2.95 74C237 2.95 74C238 2.95 74C239 2.95 74C240 2.95 74C241 2.95 74C242 2.95 74C243 2.95 74C244 2.95 74C245 2.95 74C246 2.95 74C247 2.95 74C248 2.95 74C249 2.95 74C250 2.95

<b>7400 TTL</b>	<b>LINEAR</b>	<b>CMOS</b>
SN7400N 14 SN7401N 14 SN7402N 14 SN7403N 14 SN7404N 16 SN7405N 21 SN7406N 20 SN7407N 28 SN7408N 24 SN7409N 24 SN7410N 16 SN7411N 29 SN7412N 33 SN7413N 45 SN7414N 70 SN7415N 35 SN7416N 39 SN7417N 37 SN7418N 39 SN7419N 39 SN7420N 19 SN7421N 30 SN7422N 49 SN7423N 37 SN7424N 29 SN7425N 29 SN7426N 29 SN7427N 29 SN7428N 26 SN7429N 31 SN7430N 27 SN7431N 27 SN7432N 27 SN7433N 30 SN7434N 85 SN7435N 59 SN7436N 75 SN7437N 75 SN7438N 75 SN7439N 75 SN7440N 75 SN7441N 75 SN7442N 75 SN7443N 75 SN7444N 75 SN7445N 75 SN7446N 75 SN7447N 75 SN7448N 75 SN7449N 16 SN7450N 16	H TO 5 NDIP CN MINI DIP D CER DIP K TO3 LM109H 3.50 LM311D 90 LM709CN 40 LM331CN 1.75 LM7100CN 70 LM312H 3.58 LM7100CN 70 LM338H 1.50 LM711CH 40 LM300CN 1.20 LM711CH 40 LM300CN 1.20 LM712CN 3.50 LM301A 45 LM324N 1.65 LM723CH 55 LM339N 1.50 LM723CN 55 LM302N 1.25 LM320 5T 2.25 LM725CN 1.50 LM320N 1.25 LM320 12K 2.50 LM732CN 1.00 LM304H 2.00 LM320 12T 2.75 LM732CN 1.00 LM305H 85 LM340 5K 1.95 LM731CN 35 LM305AH 1.05 LM340 5K 1.95 LM731CN 35 LM306N 95 LM340 8K 1.95 LM732CN 75 LM307H 60 LM340 12K 95 LM732CH 95 LM308H 85 LM340 15K 1.95 LM733CN 95 LM309H 1.60 LM340 18K 1.95 LM734CN 95 LM308H 85 LM340 24K 1.95 LM306CN 95 LM309AH 2.00 LM555CN 45 LM555CN 1.50 LM308D 2.25 LM556CN 1.30 SG2501T 20 LM308CN 1.00 LM566CN 1.70 SG2501T 2.40 LM309K 1.00 LM709CH 40 SG2501T 8.95 RC4194 7.95 RC4195 7.95 LM310H 1.15 LM310CN 1.15 LM311H 90	CD4009 24 CD4035 120 CD4001 24 CD4040 2.45 CD4002 24 CD4042 1.20 CD4006 2.50 CD4044 1.95 CD4007 24 CD4046 2.50 CD4008 90 CD4047 2.00 CD4010 50 CD4049 60 CD4011 24 CD4050 36 CD4012 24 CD4051 1.50 CD4013 30 CD4052 1.40 CD4015 1.10 CD4053 1.40 CD4016 56 CD4054 85 CD4017 1.10 CD4059 44 CD4018 1.20 CD4071 41 CD4019 1.60 CD4072 44 CD4020 1.45 CD4081 43 CD4021 1.10 CD4082 1.10 CD4022 24 CD4083 1.10 CD4023 24 CD4084 1.30 CD4024 1.50 CD4085 5.00 CD4025 24 CD4086 1.50 CD4027 69 CD4087 1.10 CD4028 1.10 CD4088 35 CD4029 1.20 CD4089 45 CD4030 05 CD4090 65

Buy 100 (min) take 10% off

SEND FOR OUR NEW CATALOGUE... it contains all popular part types at competitive pricing. We are not a surplus dealer and you will appreciate our service when you get to know us.

TERMS: All shipments first class in U.S. for orders under \$25.00 add \$1.00 for handling. Minimum order \$10.00. California Residents add 6% tax.

**ADVANCED MICROCOMPUTER PRODUCTS**

P.O. BOX 17329 IRVINE, CALIFORNIA 92713

CIRCLE NO. 62 ON FREE INFORMATION CARD

*first time ever published!*

**CITIZENS BAND HANDBOOK 1976**

### CITIZENS BAND HANDBOOK

All the authoritative information you need on CB two-way radios to make an intelligent buying decision for transceivers, antennas and accessories. Here's a partial look at what the experts have packed into one volume.

- Over 500 CB models fully described with technical specs, features latest prices and photos.
- Lab test evaluations on mobile and base-station transceivers, both AM and SSB, spell out what the rigs can really do.
- Latest FCC Rules and Regulations discussed in down-to-earth language, so you truly know what you can and cannot do legally.
- Manufacturers' specifications "decoded" to help you read a "spec sheet" with ease.
- All about CB antennas—the true key to "talk power."
- CB language translation chart.
- How emergency CB associations can save your life!
- How phase-lock-loop digital synthesizers work.
- The latest Flash Report on upcoming CB units presented at the first all-CB-manufacturers show.

This packed-with-information Handbook is the CB publication you've been waiting for. Only \$1.75!

CITIZENS BAND HANDBOOK  
Consumer Service Division  
595 Broadway • N.Y., N.Y. 10012 **PE-106**

Please send the 1976 CITIZENS BAND HANDBOOK. I'm enclosing \$2\* (\$1.75 plus 25c for postage and handling.) Outside U.S.A. \$3, postpaid.

Print Name \_\_\_\_\_  
Address \_\_\_\_\_  
City \_\_\_\_\_  
State \_\_\_\_\_ Zip \_\_\_\_\_

\*Residents of Calif., Colo., Fla., Ill., Mich., Mo., N.Y. State, D. C. and Texas add applicable sales tax. (Postage and handling charges non-taxable.)

# GODBOUT

Now! assembled **ECONORAM** \$129.95

Our popular ECONORAM 4K x 8 RAM board is now available assembled, tested, and warranted for one year. Plug it in to your Altair or IMSAI and enjoy the same performance that has made the kit such a success—guaranteed zero wait states and current drain of 750 mA or less; on board regulation, easy address selection, and lots more. Also available in kit form for \$99.95!

BILL GODBOUT ELECTRONICS  
BOX 2355, OAKLAND AIRPORT, CA 94614

## 74 LS TTL

1/5 THE POWER OF TTL BUT NO SPEED PENALTY

00	\$0.36	22	\$0.38	124	\$2.50	168	\$1.87
01	0.36	27	0.38	132	1.50	169	1.87
02	0.36	30	0.36	138	1.38	175	1.35
04	0.42	32	0.38	139	1.38	221	1.38
08	0.38	37	0.53	155	1.38	258	1.38
10	0.36	38	0.53	157	1.25	273	2.25
1	0.38	42	1.25	160	1.85	367	1.00
20	0.36	74	0.56	162	1.85	368	1.00
21	0.38	75	0.85	163	1.85	377	1.88

**low profile sockets**  
High quality soldertail sockets...  
14 pin 10/\$1.95 16 pin 10/\$2.15  
18 pin 10/\$2.75 20 pin 10/\$3.10  
22 pin 10/\$3.50 24 pin 10/\$3.60  
36 pin 10/\$5.50 40 pin 10/\$6.15

**VECTOR'S "SLIT-N-WRAP"**  
\$24.50 +2 lbs postage  
This tool is a manual wrapping device, which supplies insulated wire directly to wrapping posts without pre-stripping or pre-cutting. More than one level of wrap is rarely required. Speed your breadboarding time tremendously with this tool, and don't bother stocking all that pre-stripped and pre-cut wire you would normally require.

BRAND NEW---74S471 8 x 256 high speed bipolar ROM in standard DIP \$9.50

GOLD-PLATED 3 LEVEL WIRE WRAPPING POSTS. IDEAL FOR MATING WITH ALTAIR/IMSAI PERIPHERALS; GIVES A SNUG FIT FOR YOUR PC BOARD.

**100 PIN EDGE CONNECTOR**  
\$5 EACH--\$22 FOR 5

**SUPERIOR "301" TYPE OP AMP**  
\*THESE 201S OFFER BETTER SPECS AND EXTENDED RANGE COMPARED TO THE 301. FACTORY NEW IN TO-99 OR MINI DIP CASE--PLEASE SPECIFY.

TERMS: Orders under \$10 add 50c; Call res add tax. No COD. Include shipping when indicated. To place BankAmericard® or Mastercard® orders call: (415) 357-7007, 24 hrs.

PLAY WITH WIRE? REQUEST OUR FLYER!

CIRCLE NO. 29 ON FREE INFORMATION CARD

## For faster service

# USE ZIP CODE

## on all mail

### CB SPECIALS—R.F. DRIVERS—R.F. POWER OUTPUTS—FETS

2SC481	1.85	2SC761	15.75	2SC866	5.85	2SC1449	1.60	40081	1.50
2SC482	1.75	2SC773	.85	2SC013	1.50	2SC475	1.50	40082	3.00
2SC495	1.10	2SC774	1.75	2SC1014	1.50	2SC1678	5.50	2SC608	4.85
2SC502	3.75	2SC775	2.75	2SC1017	1.50	2SC1679	4.75	SK3046	2.15
2SC517	4.75	2SC776	3.00	2SC1018	1.50	2SC1728	2.15	SK3047	3.75
2SC614	3.80	2SC777	4.75	2SC1173	1.25	2SC1760	2.15	SJ2095	3.50
2SC615	3.90	2SC778	3.25	2SC1226A	1.25	2SC1816	5.50	SK3048	3.25
2SC616	4.15	2SC797	2.50	2SC1237	4.50	2SC1908	.70	SK3054	1.25
2SC617	4.25	2SC798	3.10	2SC1239	3.50	2SC1957	1.50		
2SC699	4.75	2SC781	3.00	2SC1243	1.50	2SF8	3.00	2SK19	1.75
2SC710	.70	2SC789	1.00	2SC1306	4.75	HEP-S3001	1.25	2SK30	1.00
2SC711	.70	2SC796	3.15	2SC1306-1	9.00	2SD235	1.00	2SK33	1.20
2SC735	.70	2SC799	4.25	2SC1307	5.75	MRF8004	3.00		
2SC756	3.00	2SC802	3.75	2SC1307-1	6.00	4004	3.00	3SK40	2.75
2SC765	9.50	2SC803	4.00	2SC1377	5.50	4005	3.00	3SK45	2.75
2SC766	10.15	2SC839	.85	2SC1449	1.30	40080	1.25	3SK49	2.75

### JAPANESE TRANSISTORS

2SA52	60	2SB187	.60	2SC458	70	2SC815	.75	2SC1569	1.25
2SA316	75	2SB235	1.75	2SC460	70	2SC828	.75	2SC1756	1.25
2SA473	75	2SB303	.65	2SC478	80	2SC829	.75		
2SA483	1.95	2SB324	1.00	2SC491	2.50	2SC830	1.60	2SD30	.95
2SA489	80	2SB337	2.10	2SC497	1.60	2SC839	.85	2SD45	2.00
2SA490	70	2SB367	1.60	2SC515	80	2SC945	.65	2SD65	.75
2SA505	70	2SB370	.65	2SC535	75	2SC1010	80	2SD68	.90
2SA564	50	2SB405	.85	2SC536	65	2SC1012	80	2SD72	1.00
2SA628	65	2SB407	1.65	2SC537	70	2SC1051	2.50	2SD88	1.50
2SA643	85	2SB415	.85	2SC563	2.50	2SC1061	1.65	2SD151	2.25
2SA647	2.75	2SB461	1.25	2SC605	1.00	2SC1079	3.75	2SD170	2.00
2SA673	85	2SB463	1.65	2SC620	.80	2SC1096	1.20	2SD180	2.75
2SA679	3.75	2SB471	1.75	2SC627	1.75	2SC1098	1.15	2SD201	1.95
2SA682	85	2SB474	1.50	2SC642	3.50	2SC1115	2.75	2SD218	4.75
2SA699	1.30	2SB476	1.25	2SC643	3.75	2SC1166	70	2SD300	2.50
2SA699A	1.75	2SB481	2.10	2SC644	70	2SC1170	4.00	2SD313	1.10
2SA705	55	2SB492	1.25	2SC681	2.50	2SC1172B	4.25	2SD315	.75
2SA815	85	2SB495	.95	2SC684	2.10	2SC1209	.55	2SD318	.95
2SA816	85	2SB507	.90	2SC687	2.50	2SC1213	.75	2SD341	.95
		2SB511	.70	2SC696	2.35	2SC1226	1.25	2SD350	3.25
2SB22	.65			2SC712	70	2SC1243	1.50	2SD352	.80
2SB54	.70	2SC206	1.00	2SC713	70	2SC1293	.85	2SD380	5.70
2SB56	.70	2SC240	1.10	2SC732	70	2SC1308	4.75	2SD389	.90
2SB77	.70	2SC261	.65	2SC733	70	2SC1347	.80	2SD390	.75
2SB128	2.25	2SC291	.65	2SC739	70	2SC1383	.75	2SD437	5.50
2SB135	95	2SC320	2.00	2SC715	1.75	2SC1409	1.25		
2SB152	4.50	2SC352	.75	2SC762	1.90	2SC1410	1.25	C1061B	.50
2SB173	.55	2SC353	.75	2SC783	1.00	2SC1447	1.25		
2SB175	.55	2SC371	.70	2SC784	70	2SC1448	1.25	MPS-U31	4.00
2SB178	1.00	2SC372	.70	2SC785	1.00	2SC1507	1.25	MPS-80001	2.25
2SB186	.60	2SC394	.70	2SC793	2.50	2SC1509	1.25		

### POWER-TRANSISTORS HIGH-VOLT. TV. TYPE

BU204	1300V	3.90	BU207	1300V	5.40	2SC1172B	1100V	4.25
BU205	1500V	4.70	BU208	1500V	6.25	2SC308	1100V	4.95
BU206	1700V	5.90	2SC1170	1100V	4.00	2SC1325	1100V	4.95

### OEM SPECIALS

1N270	.10	2N960	.55	2N2219A	.30	2N2913	.75	2N3740	1.00	2N4401	.20
1N914	.10	2N962	.40	2N2221	.25	2N2914	1.20	2N3771	1.75	2N4402	.20
		2N967	.50	2N2221A	.30	2N2916A	3.65	2N3732	1.90	2N4403	.20
2N173	1.75	2N1136	1.35	2N2222	.25	2N3019	.50	2N3773	3.00	2N4409	.20
2N178	.90	2N1142	2.25	2N2222A	.30	2N3053	.30	2N3819	32	2N4410	.25
2N327A	1.15	2N1302	.25	2N2270	.40	2N3054	.70	2N3823	70	2N4416	.75
2N334	1.20	2N1305	.30	2N2322	1.00	2N3055	.75	2N3856	20	2N4441	.85
2N336	.90	2N1377	.75	2N2323	1.00	2N3227	1.00	2N3866	85	2N4442	.90
2N338A	1.05	2N1420	.20	2N2324	1.35	2N3247	3.40	2N3903	20	2N4443	1.20
2N398B	.90	2N1483	.95	2N2325	2.00	2N3250	.50	2N3904	20	2N4852	.55
2N404	.30	2N1540	.90	2N2326	2.85	2N3375	6.50	2N3905	20	2N5061	.30
2N443	1.75	2N1543	2.70	2N2327	3.80	2N3393	.60	2N3906	25	2N5064	.50
2N456	1.10	2N1544	.80	2N2328	4.20	2N3394	.17	2N3925	3.75	2N5130	.20
2N501A	3.00	2N1549	1.25	2N2329	4.75	2N3414	.17	2N3954	3.50	2N5138	.15
2N508A	.45	2N1551	2.50	2N2368	.25	2N3415	.18	2N3954A	3.75	2N5138	1.5
2N555	.45	2N1552	3.25	2N2369	.25	2N3416	.19	2N3955	2.45	2N5198	3.75
2N652A	.85	2N1554	1.25	2N2484	.32	2N3417	.20	2N3957	1.25	2N5294	.50
2N677C	6.00	2N1567	1.5	2N2712	.18	2N3442	1.85	2N3958	1.20	2N5296	.50
2N706	.25	2N1560	2.80	2N2894	.40	2N3553	1.50	2N4037	.60	2N5306	.20
2N706B	.40	2N1605	.35	2N2903	3.30	2N3563	.20	2N4093	85	2N5354	.20
2N711	.50	2N1613	.30	2N2904	.25	2N3565	.20	2N4124	20	2N5369	.20
2N711B	.60	2N1711	.30	2N2904A	.30	2N3638	.20	2N4126	20	2N5400	.40
2N718	.25	2N1907	4.10	2N2905	.25	2N3642	.20	2N4141	20	2N5401	.35
2N718A	.30	2N2060	1.85	2N2905A	.30	2N3643	.15	2N4142	20	2N5457	.50
2N720A	.50	2N2102	.40	2N2906	.25	2N3645	.15	2N4143	20	C103Y	.25
2N918	.35	2N2218	.25	2N2906A	.30	2N3646	.14	2N4220A	45	C103D	.40
2N930	.25	2N2218A	.30	2N2907	.25	2N3730	1.50	2N4234	95	C106B1	.50
2N956	.30	2N2219	.25	2N2907A	.30	2N3731	2.75	2N4400	20	C106D1	.75

SILICON UNIJUNCTIONS		INTEGRATED CIRC.		RECTIFIERS		
2N2646	50	2N2160	65	UA703C	40	
2N2647	60	2N4870	50	709C OP. AMP.	.25	
2N6027	55	2N4871	50	741C OP. AMP.	.25	
2N6028	.70	2N4891	50	7400	.15	
D5E37	.25	2N4892	50	TA 7061P	3.50	
		2N4893	50	TA 7205P	10.00	
		2N4894	50	UPC 1001h2	6.00	
		2N4895	40	NE 555	1.25	
				IN4001	60	5.00
				IN4002	70	6.00
				IN4003	80	7.00
				IN4004	90	8.00
				IN4005	100	9.00
				IN4006	110	10.00
				IN4007	120	11.00

**New-Tone Electronics**  
P.O. Box 1738 A  
Bloomfield, N.J. 07003  
Phone: (201) 748-6171, 2, 3

**ALL PARTS GUARANTEED AND TESTED ON PREMISES.**

N.J. residents add 5% sales tax. Minimum order \$5.00. All orders add \$1.00 postage. Dealers write or phone for discount prices.

CIRCLE NO. 43 ON FREE INFORMATION CARD

### AEC ELECTRONIC IGNITION

- IMPROVES ENGINE PERFORMANCE
- INCREASES GAS MILEAGE
- CUTS MAINTENANCE COSTS

**90 DAY GUARANTEE** on Material/Workmanship  
**READER MODEL #12 \$39.95**  
 If car equipped with Tach, specify make and model of auto or Model No. of Tach.

### MICROHOOK by E-Z Hook

XM-S Micro Hook (1.75" long) Permits hookups to delicate wires where weight and leverage may damage component. Available in 10 Retma colors: red, black, blue, green, gray, orange, yellow, white violet or brown. **10 for \$7.95**

### PLESSEY SAMPLER

300 METALIZED CAPACITORS  
 18 DIFFERENT STD. VALUES **\$26.00**

### L-15 PULSE/SWEEP FUNCTION GENERATOR KIT

FEATURES: 1 Hz to 100 KHz in 5 ranges, at constant amplitude. • Sine and triangle adjustable to 100 ohms - 500 ohm Z. • 500 ohm Z. • 5% typical. • Voltage controlled sweep of sine and triangle waves. • TTL square wave has a fully adjustable pulse and drives 600 ohms - Frequencies of lower than 1 Hz and greater than 100 kHz are obtainable - short proof. Complete with power supply and metal case. **\$55.00**

### 7400N TTL

7400	18	7432	32	7480	80	74136	1.80	74177	1.20
7401	20	7433	44	7482	150	74141	1.70	74178	1.40
7402	18	7437	36	7483	82	74145	1.80	74179	1.50
7403	20	7438	35	7485	120	74147	2.00	74180	1.20
7404	21	7439	36	7486	44	74148	1.80	74181	3.10
7405	23	7440	20	7489	220	74150	1.70	74182	1.00
7406	30	7441	95	7493	62	74151	2.00	74183	1.40
7407	36	7442	56	7494	85	74152	1.20	74185	9.00
7408	28	7443	78	7495	90	74153	1.20	74188	5.00
7409	28	7444	105	7496	80	74154	1.20	74190	1.40
7410	22	7445	105	7497	500	74155	1.10	74191	1.30
7411	26	7446	105	7498	120	74156	1.20	74192	1.20
7412	36	7447	98	74105	90	74157	1.20	74193	1.20
7413	54	7448	98	74107	40	74158	1.40	74194	1.20
7414	98	7450	15	74109	45	74160	1.30	74195	1.00
7416	42	7451	16	74110	40	74161	1.40	74196	1.40
7417	42	7453	18	74112	100	74162	1.00	74197	1.40
7420	15	7454	18	74116	2.00	74163	1.50	74198	1.40
7421	38	7459	25	74118	2.00	74164	1.50	74199	1.40
7422	60	7460	19	74121	60	74165	1.60	74200	7.00
7423	35	7462	35	74122	45	74166	1.20	74201	1.50
7425	40	7472	40	74123	95	74170	2.00	74279	1.20
7426	30	7473	42	74125	55	74173	1.70	74298	1.80
7427	36	7474	42	74126	60	74174	1.20		
7428	50	7475	70	74128	60	74175	1.20		
7430	26	7476	44	74132	1.50	74176	1.20		

### HIGH SPEED TTL

74H00N	33	74H08N	40	74H73N	80	74H106N	95
74H04N	33	74H14N	33	74H14N	80		
7-L500							
74LS00N	36	74LS32N	45	74LS112N	58	74LS174N	2.20
74LS02N	36	74LS50N	92	74LS112N	58	74LS192N	4.00
74LS04N	44	74LS54N	58	74LS138N	89	74LS181N	3.69
74LS05N	45	74LS73N	58	74LS139N	80	74LS190N	2.85
74LS08N	38	74LS74N	56	74LS151N	68	74LS191N	2.85
74LS10N	36	74LS76N	65	74LS153N	80	74LS193N	2.50
74LS20N	59	74LS163N	60	74LS163N	60	74LS260AJ	4.4
74LS30N	39	74LS109N	92	74LS161N	3.00		

### SCHOTTKY TTL

74S00	44	74S11	65	74S64	80	74S114	1.20
74S02	60	74S20	65	74S74	90	74S133	8.80
74S04	55	74S30	16	74S76	1.15	74S138	2.80
74S08	80	74S32	80	74S112	1.00	74S151	2.20
74S10	55	74S40	65	74S113	1.50	74S160	3.90
				74S257	2.40		

### LINEAR IC'S

H-TO-5	N-DIP	M-MINI-DIP	D-CER-DIP	K-TO-3			
LM105H	12.00	LM308A	18.00	LM336K	2.60	LM710CN	9.00
LM105F	18.00	LM308AM	9.00	LM337K	2.60	LM715CH	3.90
LM108H	9.00	LM308M	9.00	LM339N	2.20	LM723CH	60
LM301AH	55	LM309H	1.90	LM320-5K	90	LM723CN	90
LM301AM	90	LM309K	1.90	LM320-5T	60	LM725CN	50
LM301AN	95	LM310H	1.90	LM320-1K2	90	LM725CN	50
LM302N	1.80	LM310D	3.50	LM320-2T2	50	LM733CH	1.40
LM304H	1.40	LM311H	2.50	LM340-5K2	60	LM733CD	3.50
LM305H	1.20	LM311D	4.00	LM340-6K2	60	LM733CN	2.00
LM305AH	1.40	LM311M	1.90	LM340-8K2	60	LM741CH	50
LM305N	1.40	LM312H	1.90	LM340-1K2	60	LM741CN	82
LM306H	4.00	LM316H	3.00	LM340-15K2	60	LM741CH	120
LM307H	6.00	LM318H	2.50	LM340-18K2	60	LM747CH	1.20
LM307M	1.60	LM318M	2.90	LM340-2K2	60	LM747CN	1.20
LM307N	1.00	LM318N	3.50	LM555CN	70	LM748CN	95
LM308H	1.50	LM324N	2.40	LM556CN	1.30	LM3054CN	1.50
LM308D	2.80	LM331N	1.25	LM567CN	1.70	SG4501N	2.40

### CMOS

4000AE	20	4023AE	24	4051AE	1.65	4093AE	1.55
4001AE	24	4024AE	95	4052AE	1.40	4095BE	1.95
4002AE	24	4025AE	24	4053AE	1.70	4098AE	2.50
4006AE	1.30	4026AE	250	4054AE	1.95	4099AE	2.90
4007AE	24	4027AE	55	4055AE	1.95	4502AE	1.50
4008AE	1.40	4028AE	90	4056AE	1.20	4507BE	6.00
4009AE	50	4029AE	1.20	4056A	2.50	4508BE	2.20
4010AE	50	4030AE	48	4066AE	90	4510AE	1.40
4011AE	24	4032AE	2.00	4068AE	44	4511BE	3.30
4012AE	24	4033AE	1.30	4070AE	40	4512BE	1.30
4013AE	40	4040AE	1.20	4070E	60	4514AE	5.00
4014AE	1.20	4041AE	1.25	4071AE	45	4515AE	5.00
4015AE	1.30	4042AE	1.20	4072AE	34	4516AE	1.75
4016AE	80	4043AE	1.30	4073AE	40	4518AE	1.25
4017AE	1.05	4044AE	1.10	4075AE	40	4520AE	1.28
4018AE	1.24	4046AE	3.10	4076AE	1.24	4528AE	2.20
4019AE	5.4	4047AE	2.50	4077AE	40	4585AE	2.05
4020AE	1.45	4048AE	1.43	4078AE	40	4901AE	32
4021AE	1.30	4049AE	3.68	4081BE	40	4911AE	32
4022AE	1.05	4050AE	58	4082AE	38		

### NEW FROM verewire™ WIRING SYSTEM

WIRING PEN - With unique integral spring wire clamp for wire retention on advancement and retraction. With spool. **\$7.99 each.**

ADDITIONAL WIRE SPOOLS - Package of 2 spools (120 meters) of 34 AWG wire. **\$2.68**

256x4	RAM	ADVANCED MICRO DEVICES					
P2101	4.85	256x4	RAM 1024x1	RAM			
P2101	6.25	P2111-1	6.25	P2112-2	4.85	P2102-2	4.17
P2102-2	4.85	P2111-2	4.85	P2102-4	4.17	P2102A	6.15
P2111	4.85	P2112	4.85	P2102-1	4.17	P2102A-2	6.75

### DISPLAYS - (COMMON ANODE) Data Sheet EP1000 \$25

EP1000	RED	5.50	XAN72	RED	2.00
3 pcs	EP1000	15.00	XAN52	GREEN	2.00
5 pcs	EP1000	22.50	XAN82	YELLOW	2.00
LITRONIX .3"					
DL707	RED	2.35	DL747	RED	2.50

### LED'S

.125" dia.	.160" dia.	.200" dia.
209 RED .25	216 RED .25	220 RED .25
209 YELLOW .35	216 YELLOW .30	220 YELLOW .30
209 GREEN .35	216 GREEN .30	220 GREEN .30

### LOW PROFILE

226 RED .25	5053 RED .35	MV50 RED .30
226 YELLOW .30	5053 YELLOW .40	OPTO COUPLER
226 GREEN .30	5053 GREEN .40	MCT 2 0.60
226 ORANGE .30	5053 ORANGE .40	

### TRANSISTORS

2N321	50	2N834	35	2N218A	26	2N2906	19	2N3563	1.80
2N324	55	2N918	40	2N219	28	2N2906A	20	2N3563	1.60
2N404A	50	2N930	28	2N219A	36	2N2907	16	2N3568	1.8
2N455	1.30	2N1132	50	2N221	21	2N2924A	25	2N3568	2.8
2N508A	40	2N1302	50	2N221A	25	2N2926	14	2N3569	19
2N555	60	2N1304	60	2N222	24	2N3053	36	2N3638	1.8
2N652A	50	2N1305	60	2N222A	26	2N3054	90	2N3638A	20
2N681	2.80	2N1307	65	2N2369	28	2N3055	94	2N3903	20
2N692	2.90	2N1544	40	2N2369A	29	2N3055	24	2N3904	22
2N697	25	2N1613	38	2N2484	30	2N3392	20	2N3905	20
2N706	28	2N1711	40	2N2605	48	2N3393	20	2N3906	22
2N711	34	2N1893	36	2N2713	13	2N3394	22	2N4033	30
2N711B	60	2N1990	75	2N2924	36	2N3395	24	2N4416	89
2N718	36	2N2062	05	2N2948	38	2N3416	30		
2N718A	38	2N2160	50	2N2950	36	2N3440	98		
2N744	35	2N2218	24	2N2950A	38	2N3442	15		

### MATSUO DIPPED TANTALUM CAPACITORS

MF	V	\$	MF	V	\$
15	35	33	15	40	20.99
22	35	33	10	16	.42
33	35	33	10	25	.45
47	35	33	10	35	.90
68	35	33	15	0	.45
10	35	33	15	35	1.32
15	35	33	20	16	.45
22	35	33	10	16	.42
33	35	33	10	25	.45
47	35	33	10	35	.90
68	35	33	15	0	.45
10	35	33	15	35	1.32
15	35	33	20	16	.45
22	35	33	30	20	1.32
22	35	40	20	15.3	.22
47	35	40	20	15.3	.22
47	35	45	16	16	.22
47	35	45	16	16	.22

### SGS-ATES RHYTHM GENERATOR IC'S

Designed specifically for electronic and other musical instrument designs. Detailed applications book, only **\$1.95**  
**M25281AA - 16 PIN DIP - \$15.00.** 15 programmable rhythms which cannot be superimposed. **M25381AA - 24 PIN DIP - \$19.50.** 12 programmable rhythms which can be superimposed. 16-page data sheet for both devices. Only **\$5.95**

### INDUSTRIAL QUALITY COMPONENTS

What is more important? QUALITY or PRICE?  
 We have decided to offer only the highest quality components. When quality counts, you can count on Ancrona.

### ZENER DIODES

500 mW - 5% V Price

IN5223B	2.7	22
IN5224B	2.8	22
IN5225B	3.0	22
IN5226B	3.3	22
IN5227B	3.6	22
IN5228B	3.9	22
IN5229B	4.3	22
IN5230B	4.7	22
IN5231B	5.1	22
IN5232B	5.6	22
IN5233B	6.0	22
IN5234B	6.2	22
IN5235B	6.8	22
IN5236B	7.5	22
IN5237B	8.2	22
IN5238B	8.7	22
IN5239B	9.1	22
IN5240B	10	22
IN5241B	11	22
IN5242B	12	22
IN5243B	13	22
IN5244B	14	22
IN5245B	15	22
IN5246B	16	22
IN5247B	17	22
IN5248B	18	22
IN5249B	19	22
IN5250B	20	22
IN5251B	22	22
IN5252B	24	22
IN5253B	25	22
IN5254B	27	

# Olson electronics

Parts and Accessories



UNDER DASH STEREO/CB SLIDE MOUNT

**2.99** Reg. **\$6**

Reg. **\$6**

AU-344



MULTIMETER 1000 OHMS/VOLT • Great for Hobbyists

**7.99** Reg. **\$11**

ADD POSTAGE & SALES TAX

PARTS & COMPONENTS		REG. SALE
500 MW Zener Diodes, 4.3-6.3-9.1-12 & 15 Volts	DI-052	1.00 .50
3 Unijunction Transistors, 40 V.		
375 MW, 4 ON/S	TR-441	1.29 .50
L.E.D. Pkg. of 5 Red, 2 Volt - 5 MA.	PL-233	1.19 .60
Ultra-Mini L.E.D. Pkg. of 5 Red, 2V, 5 MA	PL-289	1.29 .70
TL Calculator Key Board, 20 Keys	XM-523	5.00 1.60
3 1/2 Digit Liquid Crystal Display	XM-371	10.00 3.00
Darlington Amp. Transistor Kit, 6 Trans	TR-507	2.00 1.50
Photo Transistor, 5 Pieces-Epoxy Type	TR-502	1.00 .60
6 Amp Full Wave Bridge Rectifier 50 PIV	DI-057	1.20 .80
6 Amp Full Wave Bridge Rectifier 400 PIV	DI-058	1.90 1.00
PNP Transistor Assortment Pkg. of 10	TR-445	1.00 .60
PNP Transistor Assortment Pkg. of 10	TR-446	1.00 .60
7-Segment L.E.D. Display, 3 In. Green	XM-341	2.69 1.00
7-Segment L.E.D. Display, 3 In. Red	XM-370	2.00 1.00
7-Segment L.E.O. Display, 3 In. Yellow	XM-342	2.49 1.00

TOOLS — SPECIAL AND PRACTICAL		TL-845	2.60	2.00
Wire Wrap Tool, 30 Ga Wire on .025 Post	TL-845	2.60	2.00	
IC Insertion/Extraction Tool	TL-846	1.25	1.00	
IC Plug-in Test Adapter	TE-396	2.60	2.00	
12 Volt DC Soldering Iron, Pencil Tip	TL-793	4.00	3.00	
117 Volt AC Soldering Iron, Pencil Tip	TL-448	3.29	2.50	
Tuner/Contact Cleaner, 6 Oz. Can	TL-459	1.49	.80	
Dymo Label Maker, Uses 3/8 In. Tape	TL-752	1.89	.90	
Double Face Foam Tape 3/4 x 52 In.	TA-903	1.00	.80	

**FREE** 8 Olson Catalogs

Olson Electronics, 250 S. Forge St., Dept. IQ, Akron, Ohio 44327

Please send me  Olson Catalog

NAME \_\_\_\_\_

ADDRESS \_\_\_\_\_

CITY \_\_\_\_\_

STATE \_\_\_\_\_ ZIP \_\_\_\_\_

CIRCLE NO. 46 ON FREE INFORMATION CARD

## INSTRUCTION

LEARN ELECTRONIC ORGAN SERVICING at home all makes including transistor. Experimental kit—trouble-shooting. Accredited NHSC. Free Booklet. NILES BRYANT SCHOOL, 3631 Stockton, Dept. A, Sacramento, Calif. 95820.

EARN ELECTRONICS DEGREE by correspondence. Free information bulletin. Grantham, 2000 Stoner Avenue, Los Angeles, California 90025.

### F.C.C. EXAM MANUAL

Tests Answers for FCC First and Second Class Commercial License

COMMAND PRODUCTIONS P.O. BOX 26348-P  
REDWOOD CITY, CALIF. 94061

SCORE high on F.C.C. Exams... Over 300 questions and answers. Covers 3rd, 2nd, 1st and even Radar. Third and Second Test, \$14.50; First Class Test, \$15.00. All tests, \$26.50. R.E.I., Inc., Box 806, Sarasota, Fla. 33577

UNIVERSITY DEGREES BY MAIL! Bachelors, Masters, Ph.D.'s. Free revealing details. Counseling, Box 317-PE10, Tustin, California 92680.

SELF-STUDY CB RADIO REPAIR COURSE. THERE'S MONEY TO BE MADE REPAIRING CB RADIOS. This easy-to-learn course can prepare you for a career in electronics enabling you to earn as much as \$16.00 an hour in your spare time. For more information write: CB RADIO REPAIR COURSE, Dept. PE1096, 531 N. Ann Arbor, Oklahoma City, Okla. 73127.

LEARN WHILE ASLEEP! HYPNOTIZE! Astonishing details, strange catalog free! Autosuggestion, Box 24-ZD, Olympia, Washington 98507.

FCC LICENSE STUDY GUIDE — 377 pages. 1465 questions with answers/discussions — covering third, second, first radiotelephone examinations. \$9.95 postpaid. GSE 2000 Stoner, Los Angeles, California 90025.

HIGHLY EFFECTIVE Degree Program in Electronics Engineering. Advance rapidly! Our 31st Year. Free literature. Cook's Institute, Box 20345, Jackson, Miss. 39209.

INTENSIVE 5 week course for Broadcast Engineers. FCC First Class license. Student rooms at the school. Radio Engineering Inc., 61 N. Pineapple Ave., Sarasota, FL 33577 and 2402 Tidewater Trail, Fredericksburg, VA 22401.

FREE Educational Electronics Catalog. Home study courses. Write to: Edukits Workshop, Department 717D Hewlett, N.Y. 11557.

FCC License. New course material, new low prices. Free home study catalog. Genn Tech, 5540 Hollywood Blvd., Hollywood, CA 90028.

RADIO BROADCASTING: Become DJ! Get free tapes records - equipment. Start own station! Learn How "Radio!", Box 5516-AJ, Walnut Creek, CA 94596.

FCC EXAMINATIONS. 532 First, Second, Third Questions-Answers. Proven "topical" study method. \$7.00. "Exams", Box 5516-AJ, Walnut Creek, CA 94596.

LEARN Computer Programming (BASIC or FORTRAN) with ITI's effective correspondence courses. Also Electronics (including FCC), Mathematics, Accounting. Free information: Intermountain Technical Institute, Box 258, Jerome, Idaho 83338.

FREE! Ham Radio License Information. Send s.a.s.e. TWIN PHASE ENGINEERING, Box 661, Fremont, CA 94537.

LEARN Electronics-Mathematics. Individualized correspondence lessons. Trial \$2.00: Vinther Institute, Box 9447P, Berkeley, CA 94709.

## PERSONALS

MAKE FRIENDS WORLDWIDE through international correspondence. Illustrated brochure free. Hermes-Verlag, Box 110660/Z, D-1000 Berlin 11, Germany.

Ph.D.'S, MASTER'S, BACHELOR'S — official nonresident College Degrees easily acquired through mailorder Universities. Complete Revealing Directory — \$2. Counseling Connection, 5495 Claremont, No. BPE, Oakland, CA 94618.

## MUSICAL INSTRUMENTS

UP TO 60% DISCOUNT. Name brand instruments catalog. Freeport Music, 114 G. Mahan St., W. Babylon, N.Y. 11704.

## RUBBER STAMPS

RUBBER ADDRESS STAMPS. Free Catalog, 45 type styles. Jackson's, Dept. K, Brownsville Rd., Mt. Vernon, Ill. 62864.

# FREE

IC or FET'S WITH \$5 & \$10 ORDERS. DATA SHEETS WITH MANY ITEMS

DIODES	TRANSISTORS	TRANSISTORS	TRANSISTORS	TRANSISTORS	LINEAR IC'S
ZENERS & RECTIFIERS	2N706	\$0.24	2N4091	3/51	LM3008 \$5 \$1.75
1N456 to 1N483	2N718	24	2N4092	30.75	LM3040 \$1 1.75
1N486 to 1N496	2N720	48	2N4121	3/51	LM3045 \$1 1.75
1N497 to 1N514	2N719	3/51	2N4122	3/51	LM3046 \$1 1.75
1N515 to 1N523	2N1613	\$0.25	2N4124	5/51	LM3047 \$1 1.75
1N524 to 1N532	2N1711	29	2N4248	5/51	LM3048 \$1 1.75
1N533 to 1N541	2N1890	38	2N4249	5/51	LM3049 \$1 1.75
1N542 to 1N550	2N1891	38	2N4250	4/51	LM3050 \$1 1.75
1N551 to 1N559	2N2219	24	2N4274	5/51	LM3051 \$1 1.75
1N560 to 1N568	2N2222	6/51	2N4302	\$0.29	LM3052 \$1 1.75
1N569 to 1N577	2N2222A	5/51	2N4303	29	LM3053 \$1 1.75
1N578 to 1N586	2N2938	3/51	2N4308	5/51	LM3054 \$1 1.75
1N587 to 1N595	2N2939	3/51	2N4350	2/51	LM3055 \$1 1.75
1N596 to 1N604	2N2960	3/51	2N4350M	2/51	LM3056 \$1 1.75
1N605 to 1N613	2N2961	3/51	2N4351	3/51	LM3057 \$1 1.75
1N614 to 1N622	2N2962	3/51	2N4352	3/51	LM3058 \$1 1.75
1N623 to 1N631	2N2963	3/51	2N4353	3/51	LM3059 \$1 1.75
1N632 to 1N640	2N2964	3/51	2N4354	3/51	LM3060 \$1 1.75
1N641 to 1N649	2N2965	3/51	2N4355	3/51	LM3061 \$1 1.75
1N650 to 1N658	2N2966	3/51	2N4356	3/51	LM3062 \$1 1.75
1N659 to 1N667	2N2967	3/51	2N4357	3/51	LM3063 \$1 1.75
1N668 to 1N676	2N2968	3/51	2N4358	3/51	LM3064 \$1 1.75
1N677 to 1N685	2N2969	3/51	2N4359	3/51	LM3065 \$1 1.75
1N686 to 1N694	2N2970	3/51	2N4360	3/51	LM3066 \$1 1.75
1N695 to 1N703	2N2971	3/51	2N4361	3/51	LM3067 \$1 1.75
1N704 to 1N712	2N2972	3/51	2N4362	3/51	LM3068 \$1 1.75
1N713 to 1N721	2N2973	3/51	2N4363	3/51	LM3069 \$1 1.75
1N722 to 1N730	2N2974	3/51	2N4364	3/51	LM3070 \$1 1.75
1N731 to 1N739	2N2975	3/51	2N4365	3/51	LM3071 \$1 1.75
1N740 to 1N748	2N2976	3/51	2N4366	3/51	LM3072 \$1 1.75
1N749 to 1N757	2N2977	3/51	2N4367	3/51	LM3073 \$1 1.75
1N758 to 1N766	2N2978	3/51	2N4368	3/51	LM3074 \$1 1.75
1N767 to 1N775	2N2979	3/51	2N4369	3/51	LM3075 \$1 1.75
1N776 to 1N784	2N2980	3/51	2N4370	3/51	LM3076 \$1 1.75
1N785 to 1N793	2N2981	3/51	2N4371	3/51	LM3077 \$1 1.75
1N794 to 1N802	2N2982	3/51	2N4372	3/51	LM3078 \$1 1.75
1N803 to 1N811	2N2983	3/51	2N4373	3/51	LM3079 \$1 1.75
1N812 to 1N820	2N2984	3/51	2N4374	3/51	LM3080 \$1 1.75
1N821 to 1N829	2N2985	3/51	2N4375	3/51	LM3081 \$1 1.75
1N830 to 1N838	2N2986	3/51	2N4376	3/51	LM3082 \$1 1.75
1N839 to 1N847	2N2987	3/51	2N4377	3/51	LM3083 \$1 1.75
1N848 to 1N856	2N2988	3/51	2N4378	3/51	LM3084 \$1 1.75
1N857 to 1N865	2N2989	3/51	2N4379	3/51	LM3085 \$1 1.75
1N866 to 1N874	2N2990	3/51	2N4380	3/51	LM3086 \$1 1.75
1N875 to 1N883	2N2991	3/51	2N4381	3/51	LM3087 \$1 1.75
1N884 to 1N892	2N2992	3/51	2N4382	3/51	LM3088 \$1 1.75
1N893 to 1N901	2N2993	3/51	2N4383	3/51	LM3089 \$1 1.75
1N902 to 1N910	2N2994	3/51	2N4384	3/51	LM3090 \$1 1.75
1N911 to 1N919	2N2995	3/51	2N4385	3/51	LM3091 \$1 1.75
1N920 to 1N928	2N2996	3/51	2N4386	3/51	LM3092 \$1 1.75
1N929 to 1N937	2N2997	3/51	2N4387	3/51	LM3093 \$1 1.75
1N938 to 1N946	2N2998	3/51	2N4388	3/51	LM3094 \$1 1.75
1N947 to 1N955	2N2999	3/51	2N4389	3/51	LM3095 \$1 1.75
1N956 to 1N964	2N3000	3/51	2N4390	3/51	LM3096 \$1 1.75
1N965 to 1N973	2N3001	3/51	2N4391	3/51	LM3097 \$1 1.75
1N974 to 1N982	2N3002	3/51	2N4392	3/51	LM3098 \$1 1.75
1N983 to 1N991	2N3003	3/51	2N4393	3/51	LM3099 \$1 1.75
1N992 to 1N1000	2N3004	3/51	2N4394	3/51	LM3100 \$1 1.75

## \*SUPER SPECIALS:

1N914 100V/10mA Diode	20/S1	MFP102 200MHz RF Amp	3/S1
1N4001 100V/1A Rect	15/S1	40673 MOSFET RF Amp	\$1.75
1N4154 30V 1N914	25/S1	LM324 Quad 741 Op Amp	3/51
BR1 150V 1/8 Bridge Rect	4/S1	LM378 Pos Volt Reg mDIP	2/51
2N2222A NPN Transistor	6/S1	NE555 Timer mDIP	2/51
2N2907 PNP Transistor	6/S1	LM723 2-37V Reg DIP	3/51
2N3055 Power Xistor 10A	89	LM741 Comp Op mDIP	4/51
2N3904 NPN Amp/Sw @100	6/51	LM1458 Dual 741 mDIP	3/S1
2N3906 PNP Amp/Sw @100	6/51	CA3086 5 Trans Array DIP	5/51
CP650 Power FET 1/2 Amp	55	RC4195DM 15V/50mA mDIP	1.25

RF391 RF Power Amp Transistor 1025W @ 3.30MHz TO-3	\$5.00
565X Triode 1 1/2-1W Different pinout from 565 (w/data)	\$5.51
RC4194KT Dual Tracking Regulator 10.2 to 30V @ 200mA TO-66	\$2.50
RC4195KT Dual Tracking Regulator 15V @ 100mA (TO-66)	\$2.25
8038 Waveform Generator ~VIA Wave With Circuits & Data	\$3.75

**ADVA KIT:** Use with CMOS TTL DTL RTL HTL TTL and most MOS IC's. Built-in protection against polarity reversal and overvoltage. Draws only a few mA from circuit under test. Dual LED readout. Complete kit includes case and clip leads. \$8.95

**VARIABLE REGULATED POWER SUPPLY KIT** — Continuously variable from 3 to over 15 Volts. Short-circuit proof with electronic current limiting at 300 mA. Compact size and typical regulation of 0.1% make this a great bench or lab power supply. \$11.95

**FIXED REGULATED POWER SUPPLY KITS** — Short circuit proof with thermal current limiting. Compact size and typical regulation of 0.5% make these ideal for most electronic projects. Available for 5V @ 500mA, 6V @ 500mA, 9V @ 500mA, 12V @ 400mA, 15V @ 300mA. Specify voltage when ordering. \$8.95 ea.

These easy-to-assemble kits include all components, complete detailed instructions and plated fiberglass PCB boards. Power supply kits do not include case or meters. Add \$1.25 per kit for postage and handling.

**MAIL NOW! FREE DATA SHEETS** subscribed with many items from this ad. FREE ON REQUEST. 741 Op Amp w/ new order of \$5 or more. 749 Dual Op Amp or two E100 FET's with every order of \$10 or submitted prior to 12/31/76. One free item per order. ORDER TODAY. All items subject to prior sale and prices subject to change without notice. All items are new surplus parts. 100% functionality tested.

**WRITE FOR FREE CATALOG #76** offering over 350 semiconductors carried in stock. Send 13¢ stamp.

**TERMS:** Send check or money order (U.S. funds) with order. We have 1st Class postage to U.S. Canada and Mexico (except on kits) \$1.00 handling charge on orders under \$10. Calif. res. adds 6% sales tax. Foreign orders add postage. CDD orders add \$1.00 service charge.

# ADVA ELECTRONICS

BOX 4181 EB, WOODSIDE, CA 94062  
Tel. (415) 851-0455

CIRCLE NO. 4 ON FREE INFORMATION CARD

## RECORDS

**RECORD RATERS WANTED!** Anyone qualifies. We ship you nationally released LP's to rate. We pay postage and handling. You pay nothing for LP's. All you pay is small membership fee. Applicants accepted "first come basis." Write: E.A.R.S., Inc., Dept PE, Box 10245, 5521 W. Center Street, Milwaukee, Wisconsin 53210.

**FREE RECORD CATALOG**—Pop, classics, jazz, shows, opera. Wide selection, low prices, prompt service. Write for latest catalog. Rose Records, 214 S. Wabash, Chicago, Ill. 60604.

## EMPLOYMENT OPPORTUNITIES

**ELECTRONICS/AVIONICS EMPLOYMENT OPPORTUNITIES.** Report on jobs now open. Details FREE. Aviation Employment Information Service, Box 240E, Northport, New York 11768.

## POPULAR ELECTRONICS



OCTOBER 1976

## ADVERTISERS INDEX

READER SERVICE NO.	ADVERTISER	PAGE NUMBER
1	A P Products, Incorporated	71
2	Ace Electronic Parts	131
	Acoustic Fiber Sound Systems, Inc.	25
3	Active Electronic Sales Corp.	114
4	Adva Electronics	130
62	Advanced Microcomputer Products	137
6	Allison Automotive Co.	70
7	Allraj Electronics	113
8	Ancona Corp.	129
9	Anes Inc.	124
	Audio Technica, U.S. Inc.	18
11	B&F Enterprises	123
15	B&K, Product of Dynascan	5
12	Bennies Warehouse	67
13	Bullet Electronics	103
	CREI Capitol Radio Engineering Institute	26, 27, 28, 29
16	C&S Marketing Assoc.	16
	Circuit Design, Inc.	87
	Cleveland Institute of Electronics, Inc.	60, 61, 62, 63
14	Cobra Product of Dynascan	SECOND COVER
17	Continental Specialties Corporation	7
18	Delta Electronics Co.	112
19	Delta Products, Inc.	105
20	Digi-Key Corporation	122
	Dixie Hi-Fidelity	108
21	EICO	90
22	Edlie Electronics, Inc.	124
23	Edmund Scientific Co.	110
24	Edmund Scientific Co.	132
26	Eltron	123
27	Empire Scientific Corp.	75
28	Formula International Inc.	104
	GFN Industries, Inc.	19
29	Godbout Electronics, Bill	128
30	Grantham School of Engineering	107
31	Handic U.S.A., Inc.	95
5	Heath Company	78, 79, 80, 81
84	Hufco	104
	IMS Associates, Inc.	9, 83, 126
34	Illinois Audio	107
35	International Electronics Unlimited	118
36	James	120, 121
37	James	125
38	Jensen Tools and Alloys	108
33	Johnson Co., E.F.	FOURTH COVER
39	Labtronics, Incorporated	106
40	Lafayette Radio Electronics	33
41	Lafayette Radio Electronics	89
42	McIntosh Laboratory, Inc.	70
82	MITS	11
	NRI Schools	12, 13, 14, 15
	National Technical Schools	96, 97, 98, 99
43	New-Tone Electronics	128
44	Newman Computer Exchange	106
45	Non-Linear Systems, Inc.	108
46	Olson Electronics	130
47	Optoelectronics, Inc.	119
48	PAIA Electronics	108
49	Pathcom, Inc.	17
50	Phase Linear Corporation	6
51	Poly Paks	117
52	Polymorphic Systems	20
	Processor Technology	103
54	Quest Electronics	112
55	Radio Shack	21
56	Royce Electronics	23
57	SAE	102
58	SBE, Inc.	2
59	S.D. Sales Co.	111
60	Seelbi Computer Consulting Inc.	109
61	Schweber Electronics	22
63	Sencore	100, 101
64	Shakespeare Electronics Group	35
65	Shakespeare Industrial Fiberglass Division	59
66	Shure Brothers Inc.	24
67	Solid State Sales	123
68	Southwest Technical Products Corp.	77
69	Sparkomatic	54
	Stanton Magnetics, Inc.	THIRD COVER
71	Stereo Discounters	109
	Surplus Center	112
72	T.K. Enterprises	106
75	Tab Books	8
73	Tenna Corporation	36
	Texas Instruments Incorporated	1
74	Tri-Star Corporation	109
75	Ungar	49
76	Wahl Clipper Corporation	106
77	Wawasee Electronics	93
78	WeatherAlert	85
79	Weller-Xcelite Electronics Division	102
80	Yamaha International Corporation	31

CLASSIFIED ADVERTISING

110, 112, 118, 122, 124, 126, 127, 130, 131

## PRO SPORTS ACTION FILMS

FALL... TIME TO START A SPORTS FILM COLLECTION: '76 Super Bowl X (Steelers / Cowboys) or '75 IX (Steelers / Vikings); Super 8 Color, 200' reel, \$19.95 ea; B&W, \$8.95 ea + shipping. Include 1974 & '75 World Series. Official Films; 200' Super 8 B&W, \$8.95 ea; Color, \$19.95 ea (add \$0.85 per film for shipping — Canada, \$1.25 ea). Round out your collection with '76 & '75 Stanley Cup (Canadiens / Flyers, Flyers / Islanders), each 400' Mag Sound Super 8 Color, only \$49.95 ea + \$1.50 Postage. Handling (limited offer). (Super 8, 200' Silent Color, \$19.95 ea + \$0.85 shipping). New Castle or Columbia catalogs, \$0.50 ea. Sportlite, \$0.25 (coins, stamps, no checks, pls.). SPORTLITE, Elect-10, Box 24-500, Speedway, IN 46224.

## MISCELLANEDUS

WINEMAKERS Free illustrated catalog yeasts, equipment. Semplex, Box 12276P, Minneapolis, Minn. 55412.

POPULAR ELECTRONICS INDEX for 1975 now available. Prepared in cooperation with the Editors of "P/E," this index contains hundreds of references to product tests, construction projects, circuit tips and theory and is an essential companion to your magazine collection. 1975 Edition, \$1.50 per copy. 1972, 73, and 74 editions also still available at \$1.50 each, or \$5.50 for the set of four (1972, thru 1975). Add \$.25 per order for postage and handling.

INDEX, Box 2228, Falls Church, Va., 22042



Popular Electronics

ANNUAL INDEX

..... 1975

### ACE OF THE MONTH SPECIALS

All new ENGINEERING APPRAISAL ASSORTMENTS first quality

 <p><b>DIPPED POLYESTER FILM CAPACITORS</b> 100 for \$4.95</p>	 <p><b>DISC CAP ASSORTMENT</b> includes 22 of 220pf, 47 of 470pf, 100 of 100pf, 100 of 100pf Prime 200 PCS FOR \$3.95</p>
<p><b>KEYBOARD ASSORTMENT</b> 5 for \$9.95</p> <p><b>CALCULATOR &amp; COMPUTER</b></p>	<p><b>SLIDE SWITCH ASSORTMENT</b> standard and miniature 40 for \$5.00</p>
<p><b>200 ELECTROLYTIC ASSORTMENT</b> \$9.95 <small>MINIATURE ALUMINUM ANOXYLATED FROM 100uf 50v to 470uf 25v</small></p>	<p><b>1% PRECISION RESISTORS</b> 200 for \$4.95 <small>Assortment contains a balanced inventory</small></p>
<p><b>AC adapter ASSORTMENT</b> 4 DIFFERENT models for \$9.95</p>	<p><b>POWER CORD ASSORTMENT</b> 6 for \$2.95 2 and 3 conductor 6-8 ft. P.L. Listed</p>



**ASCII COMPUTER KEYBOARDS**  
These keyboards were manufactured for use on Texas Instruments' line of Silent 700 series data terminals. They are fully encoded with TTL large scale integrated circuits (T.I. TMS-5000 in 40 pin socket). Additional IC's provide a parallel 7 bit, without parity, code plus a strobe signal indicating "valid" data and six other independent outputs for those special keys which are not encoded. Internal circuitry provides for two key rollover and de-bounce. Output is on standard 10 pin double readout connector for data and power in put. And 8 pin double readout connector for six special switch functions.

K8-6 Clara/Pandar 7206271 New tested \$39.95  
T.I. Part number 9593271 Used tested \$29.95

A 56 key ASCII encoded Alphabetic keyboard with six extra switch closures to ground marked HERE IS PAPER ADV. BREAK REPEAT TAPE + TAPE-



**ACOUSTIC COUPLER**  
This coupler was manufactured by Novation, Inc. Tarzana, California for use in Texas Instruments' model 725 Electronic Data Terminal. It is compatible with Bell 103 and 113 data sets or equivalent. The coupler operates asynchronously to a maximum speed of 450 baud in the full or half duplex mode coupled to a standard telephone handset. Transmits 1270Hz for mark and 1070Hz for space. Receive frequency is 2225Hz for mark and 2025Hz for space. Unit requires ± 12 VOLTS and ± 5 VOLTS for operation. Complete with schematic & all pertinent information. Fully reconditioned, calibrated, and guaranteed. \$47.50

LM301AH 6/\$1.00 100 — 14.95

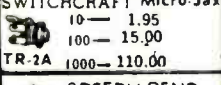

**SWITCHCRAFT Micro-Jax**  
10 — 1.95  
100 — 15.00  
TR-2A 1000 — 110.00



**SPEEDY BEND**  
By PRODUCTION DEVICES  
\$1.95  
NEW BLS

**BISMUTH ALLOY.**  
Melts in boiling water  
4 oz. inqt \$3.95  
1 lb. \$9.95

**Kynar solid silver-plated wire wrap wire**  
30 AWG Blue Or Yellow  
Red or White  
1000 FT SPOOL 9.95  
26 AWG Red or Black  
1000 FT SPOOL 10.95

**DISCRETE LEDS**  
MV50 RED 100 for \$14.50  
200" dia. \$14.50  
RED  
125" dia. \$14.00

**HEAT SHRINKABLE TUBING** Assl. 2.95  
**25 6" LENGTHS**  
Various sizes & colors.

**COMPUTER GRADE CAPACITOR**  
**36D POWERLYTIC**  
5,000 Mfd. 30 WVDC  
10 for 9.00

6 V @ 40 ma  
\$39.95/250

**6' 2 CONDUCTOR 18 GA. Black**  
MOLDED VINYL CONNECTOR FOR ROUND PINS  
Matches with Recessed panel mounting TV type plug  
5 for \$1.98 30 for \$10.00 100 for \$25.00  
Male Connector for use with cord above. 10 for \$1.95

**PRINTED CIRCUIT BOARD G-10**  
1.16 thick unetched copper  
clad 1 oz 2 sides

Size	1	10	100
3x6"	.50	2.50	19.95
4x12"	1.00	5.00	39.95
8x8"	1.50	9.95	39.73

PC Mount 10 for \$15.00 100 for \$69.95

**CLOCK OF OUTPUT 1 OUTPUT 2**

CALCU- VAC	DCMa	VAC	DCMa
LATOR	2DCT	50	80 20

100 for \$69.95

**TMS 4030 JL, 4096-BIT DYNAMIC RAM** Low Power 400 mW \$9.95  
with data and 27 Pin SOCKET  
removed from sockets 8 FOR \$64.95  
Tested and guaranteed

**ELECTRONIC PARTS**  
5400 Mitchelldale, B-8  
Houston, Texas 77092

**TERMS** We pay postage, unless otherwise specified. Include check or money order, no COD. Texas residents add 5% sales tax. Canada and Mexico add \$2.50. Overseas countries add \$5.00.  
We will ship UPS unless otherwise specified.  
**ORDERS OVER 10 lbs. are shipped Collect**

OCTOBER 1976

CIRCLE NO. 2 ON FREE INFORMATION CARD

131

www.americanradiohistory.com

# LIVE IN THE WORLD OF TOMORROW... TODAY!

And our FREE 164 PAGE CATALOG is packed with exciting and unusual values in electronic, hobby and science items — plus 4,500 finds for fun, study or profit... for every member of the family.

## A BETTER LIFE STARTS HERE

### OUR MYSTICAL MUSICAL MACHINE

...gets it on! Fascinates with an automatic 256-note pseudo-random tone pattern. The controls let you adjust beat, volume & pitch. Finger its 3 photocells, and you creatively vary the tone of its continuous "music". Output jack permits a patch-in to guitar or band amplifier for some really wild effects. Jack it into your stereo (use an external amplifier), or recorder for a great tape. Good executive toy? You bet! Incls. 9V tr. batt., instrs. Just 1.3 lb.



No. 72,203AV (9 3/16 x 5 1/4 x 3 1/16") ..... \$59.95 Ppd.

### SUPER POWER FOR ANY AM RADIO

New antenna assist turns a tiny transistor into a tiger, has pulled in stations up to 1000+ miles away! Just set beside radio (no wires, clips, grounding) and fine-tune Select-A-Tenna's dial to same frequency — "gangbusters"! Great for clearing weak signals in radio depressed areas, off-coast islands, crowded frequency stations. Solid state—uses no electricity, batts., tubes.



Stock No. 72,095AV ..... \$19.95 Ppd.  
**ULTRA SELECT-A-TENNA**  
 No. 72,147AV (\*OVER 1000 MI.) ..... \$24.95 Ppd.

### NASA-CHOSEN FOR APOLLO/SOYUZ

157 mi. out in space, the Astronauts used this super 20x60 binocular (modified) to view Earth! Our biggest, most powerful for distance. Far-off objects come in big, clear & sharp to the edge through big 60mm objective lenses; 173-ft. field of view at 1000 yds. Relative brightness, 9.0. Fully coated optics; 20X spcl design eye lenses. Coated BK-7 Porro prism. Extra long All-American style with fold-down rubber eyecups. Includes case & straps.



No. 1556AV ... (9 1/4 x 8 1/2"; 47.5 oz.) ..... \$99.95 Ppd.  
 No. 1559AV ... (4 1/2 x 6 1/4"; 19 oz.) ..... \$29.95 Ppd.

### PRO ELECTRONIC SOUND CATCHER

Parabolic mike w/ 18 3/4" transparent reflecting shield & 2 I.C.'s in amplifier magnifies signals 100x that of omni-direction mikes. Catch sounds never before heard! Highest signal to noise ratio poss. Earphones, tape recorder output, tripod socket; req. two 9v trans. batt. (not incl).



No. 1649AV ... (5 1/2 LB.) ..... \$299.00 Ppd.  
**LOW COST MODEL: NO EARPHONES, ELECTR. CIRC.**  
 No. 1665AV ..... \$149.95 Ppd.  
**LOWER SENSITIVITY ECON. MOD. W/O ELECTR.**  
 No. 80,242AV ..... \$89.50 Ppd.

WHEN YOU COME TO PHILADELPHIA BE SURE TO SEE  
**FREE BICENTENNIAL LIGHT SHOW**  
 IN BARRINGTON, N.J. ONLY 10 MINUTES AWAY AT  
**EDMUND FACTORY STORE**

### 4 1/4" ASTRONOMICAL TELESCOPE

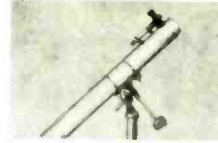

See moon craters, rings of Saturn, double stars. Features fine f/10 mirror\* (verified better than 1/10 wave with a scatter plate interferometer) to insure performance to theoretical limit of resolution. Equatorial mount; rack & pinion focusing; aluminum tube, 6X finder, 25mm F.L. 45X Kellner achromatic eyepiece & Barlow lens to double and triple power to 135X. Incls FREE Star Chart plus 2 Books. \*Pyrex."

No. 85,260AV (SHPG. WT. 42 LB.) ..... \$159.50 FOB  
 No. 85,261AV (CLOCK DR.; 45 LB.) ..... \$199.50 FOB

### AN ULTRA-MINIATURE AM RADIO!



It's about the size of a small matchbox—and your ear will light up when you hear it. Pulls in stations with amazing volume and clarity (number depends on locale), yet you can wear it on your key chain, conceal it in pocket or purse! Get news, sports, music wherever you go—listen to the game as you watch it at the stadium. Just insert the earplug (incl) and your directional AM mini marvel plays! Runs ab. 100 hrs. on 2 hearing aid batts (incl). A super gift!

No. 1976AV ... (LESS THAN 1 1/4 OZ.!) ..... \$14.95 Ppd.

### SEE MUSIC IN PULSATING COLOR



New 3-Channel Color Organ adds to music listening pleasure, lets you modulate 3 independent strings of colored lamps with intensity of your music to create an audio "light show." They flash, vary in brightness related to music's rhythm, pitch, volume—pulsating lighting performance to music! Fully assembled & priced half that of others, the Edmund Sound To Light Control is a terrific value. Plug in, turn on!

No. 42,309AV ... (ASSEMBLED) ..... \$17.95 Ppd.  
 No. 42,336AV ... (UNASSEMBLED) ..... \$13.95 Ppd.

### LOW COST INFRA-RED VIEWER



For Infra-red crime detection surveillance, security system alignment, I.R. detection, laser checking, nite wildlife study, any work req. I.R. detection & conv. to visible spectrum. Self cont. scope w/ everything incl I.R. light source. 6v or 12v power, 6032 I.R. converter tube, f/3.5 objective lens, adjust. triplet eyepiece. Provides 1.6X, focuses from 10' to infinity.

No. 1659AV (11 x 14 1/4 x 3") ..... \$285.00 Ppd.  
**WITHOUT LIGHT SOURCE**  
 No. 1663AV ..... \$225.00 Ppd.

### WOW! TR METAL DETECTOR: \$69.95



Super-sensitive transmitter/receiver unit at a never-before price, w/feats. of \$150 types. Terrific selectivity—10-turn (not just 90°) metal/mineral tuner! 6" waterproof search coil find a cent at 6"; telescoping adjust; shaft gives 44" lgh; 1/4" stereo earphone jack; all metal constr.

Perfect balance & feather light, it incl 8 "AA" batteries. Lifetime warranty!  
 No. 80,251AV (JUST 38 OZ.!) ..... \$69.95 Ppd.  
**STARTERS' BFO CHALLENGER I (32 OZ.)**  
 No. 80,222AV (ALUMINUM CONSTR.) ..... \$39.95 Ppd.



**MAIL COUPON FOR GIANT FREE CATALOG!**

164 PAGES • MORE THAN **4500 UNUSUAL BARGAINS**

Completely new 1977 edition. New items, categories, illustrations. Dozens of electrical and electromagnetic parts, accessories. Enormous selection of Astronomical Telescopes. Unique lighting and ecological items. Microscopes, Binoculars, Magnifiers, Magnets, Lenses, Prisms. Hard-to-get surplus bargains. Ingenious scientific tools. 1000's of components.

**EDMUND SCIENTIFIC CO.**  
 300 Edscorp Building, Barrington, N.J. 08007  
 Please rush Free Giant Catalog "AV"

Name, \_\_\_\_\_  
 Address \_\_\_\_\_  
 City \_\_\_\_\_ State \_\_\_\_\_ Zip \_\_\_\_\_



**COMPLETE & MAIL WITH CHECK OR M.O.**

**EDMUND SCIENTIFIC CO.** 300 Edscorp Building, Barrington, N.J. 08007

PLEASE SEND GIANT FREE CATALOG "AV"

Charge my  American Exp.  BankAmericard  Master Chg

Interbank No \_\_\_\_\_

My Card No. Is \_\_\_\_\_

Card Expiration Date \_\_\_\_\_

**30-DAY MONEY-BACK GUARANTEE.** You must be satisfied or return any purchase in 30 days for full refund.

How Many Stock No. \_\_\_\_\_

Description (800) 547-3488 Price Each \_\_\_\_\_ Total \_\_\_\_\_

How Many	Stock No.	Description	Price Each	Total

Add Service and Handling Charge \$1.00

enclose  check  money order for TOTAL \$ \_\_\_\_\_

Signature \_\_\_\_\_

Name \_\_\_\_\_

Address \_\_\_\_\_

City \_\_\_\_\_ State \_\_\_\_\_ Zip \_\_\_\_\_

# Stanton Stereo Wafers™

The livest sound, the highest fidelity  
...plus the livest look.



## Looks Just Great...

Hail to a totally new concept and technology in headphones. And hail to an Open Audio design that gives you the lightest weight comfort you've ever experienced with headphones that possess truly top quality sound.

These ultra thin headphones have been designed and engineered to meet important professional needs: extreme comfort over long listening periods, a particular wide frequency response, and a broad dynamic range. A major factor in the success of the design is the use of rare earth elements in the compound of the permanent magnets of each earpiece. Besides having superior magnetic properties, these magnets

## ...Any Way You Look At It!

are also of much smaller size, while still allowing Stanton to achieve an improved response over headphones incorporating conventional permanent magnets.

The soft foam cushioned headband is exceptionally comfortable and has a trendy brushed denim fabric covering. The earpiece yokes incorporate specially designed pivots which allow the earpieces to fit perfectly against the ear, whatever the shape of the head.

Write us for the specs — they're magnificent! And ask for a demonstration as soon as possible at your Stanton dealer.



Write today for further information to Stanton Magnetics, Inc., Terminal Drive, Plainview, N.Y. 11803.

CIRCLE NO. 70 ON FREE INFORMATION CARD

# HIT THE ROAD WITH THE AUTOMATIC CB. JOHNSON.

"This year, lots of folks are takin' to the road for trips and adventures of all kinds. They're getting more fun out of every mile with the automatic CB from Johnson. And y'all know it's right handy if you're in a heap of trouble, too."

That's right, Sheriff. Johnson's built-in, automatic controls make operation easier and safer, performance better. Exclusive voice tailored audio circuitry automatically drops off signals outside voice frequencies to give you great reception.



Our automatic noise limiter keeps reception clean and built-in gain control prevents blasting and fading.

Johnson's unique electronic speech compression automatically selects and compresses voice frequencies to

produce uniform, high-level modulation, maximum range. All automatically.

When you hit the road, go with Johnson CB. We back every Johnson with a full year parts and labor warranty and walk-in service at more than 850 locations. See a Johnson CB dealer and take off on *the great American adventure.*



**JOHNSON**

E. F. JOHNSON COMPANY, WASECA, MINN. 56093  
In Canada: A. C. Blimmond & Sons, Ltd.

*Joe Higgins*  
National Safety Sheriff

**JOHNSON CB. THE GREAT AMERICAN ADVENTURE.**

CIRCLE NO. 33 ON FREE INFORMATION CARD

[www.americanradiohistory.com](http://www.americanradiohistory.com)