

**MACKIE®.**

**Mackie Compact Mixers  
Modifications**

**LOUD**  
TECHNOLOGIES INC.

# Mackie Compact Mixers Modifications

## General Notes about Modifications

We've tried to make these mixers as universal as possible, but you can't please everyone all the time. For certain applications, you may find these signal routing changes beneficial.

They're easy to make if you have experience soldering and working on electronic equipment, but if you don't have the experience, this is NOT a good place to learn. Take your mixer and this book to a qualified technician.

Here are the obligatory warnings and disclaimers that our lawyers made us include. We think it's a good idea to heed them (the warnings, not the lawyers), too.



**Caution!** These modification instructions are for use by qualified personnel only. To avoid electric shock, do not perform any servicing other than changing the fuse unless you are qualified to do so. Refer all servicing and modifying to qualified personnel.

## Mackie Disclaimer

Any modification of any Mackie product must be performed by a competent electronic technician. LOUD Technologies accepts no responsibility for any damages or injuries caused by any modification, regardless of the source of the modification instructions or the qualifications of the technician performing them. In the case of such damages, LOUD Technologies may declare warranty privileges void. BE CAREFUL!

## About Jumpers

These modifications involve cutting traces on the circuit board and installing jumpers between pads. We recommend solid (non-stranded) wire, 26-28 gauge. The type of wire used for wire-wrapping is easy to form, lays neatly against the circuit board, and has insulation that doesn't melt easily from the heat of a soldering iron.

When installing jumpers, do not run their ends through holes in the circuit board. Rather, solder them flat against the desired pad (the flat silver area, possibly with a hole in the middle). Make sure the ends of these flat wires do not extend beyond the pad.

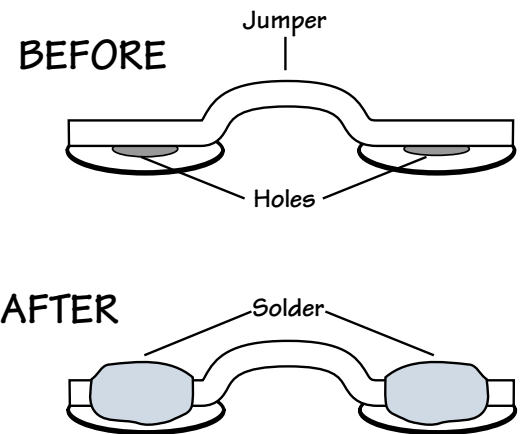

# 1202-VLZ PRO Modifications

## Pre-Fader Mod (Aux To Monitor)

This modification changes AUX SEND 2 to be *pre-fader, pre-mute* instead of *post-fader, post-mute*. (“fader” refers to the channel GAIN knob, and “mute” refers to the channel’s MUTE/ALT 3-4 switch.) In order to convert the entire mixer, it must be done on each channel. Is slightly more involved for the stereo channels 5–12. The work area is on the underside of the circuit board, near the channel AUX SEND knobs.

1. Remove all cords, including the power cable, from the 1202-VLZ PRO.
2. Place the mixer upside-down on a dry, non-marring surface.
3. Remove the screws that attach the bottom cover. Keep track of what screws go where. Remove the bottom cover.
4. Using a sharp “X-acto” type knife, cut the conductor at point ‘A’ (channels 1–4) or the conductors at points ‘AL’ and ‘AR’ (channels 5–12). Be careful to cut all the way through the conductor, and do not cut any nearby traces.
5. Add a jumper from point ‘B’ to the square pad at point ‘A’ (channels 1–4) or from points ‘BL’ to ‘AL’ and ‘BR’ to ‘AR’ (channels 5–12).
6. Repeat for all channels.
7. Check your work very carefully, then put the bottom cover back the way you found it. You’re done!

## Pre-Mute Mod

This modification changes AUX SEND 1 (in *post* mode) and AUX SEND 2 to receive signal regardless of the channel’s MUTE/ALT 3-4 switch position, but still be *post-fader* (GAIN knob). In order to convert the entire mixer, it must be done on each channel. It is slightly more involved for the stereo channels 5 through 12. The work area is on the underside of the circuit board, near the channel MUTE/ALT 3-4 switches.

1. Remove all cords, including the power cable, from the 1202-VLZ PRO.
2. Place the mixer upside-down on a dry, non-marring surface.
3. Remove the screws that attach the bottom cover. Keep track of what screws go where. Remove the bottom cover.
4. Using a sharp “X-acto” type knife, cut the conductor at point ‘C’ (channels 1–4) or the conductors at points ‘CL’ and ‘CR’ (channels 5–12). Be careful to cut all the way through the conductor, and do not cut any nearby traces.
5. Locate the 12 pins that comprise the underside of each MUTE/ALT 3-4 switch.
6. Add jumpers as shown in the illustration on the next page—they’re not marked on the circuit board itself, so be careful.
7. Repeat for all channels.
8. Check your work very carefully, then put the bottom cover back the way you found it. You’re done!

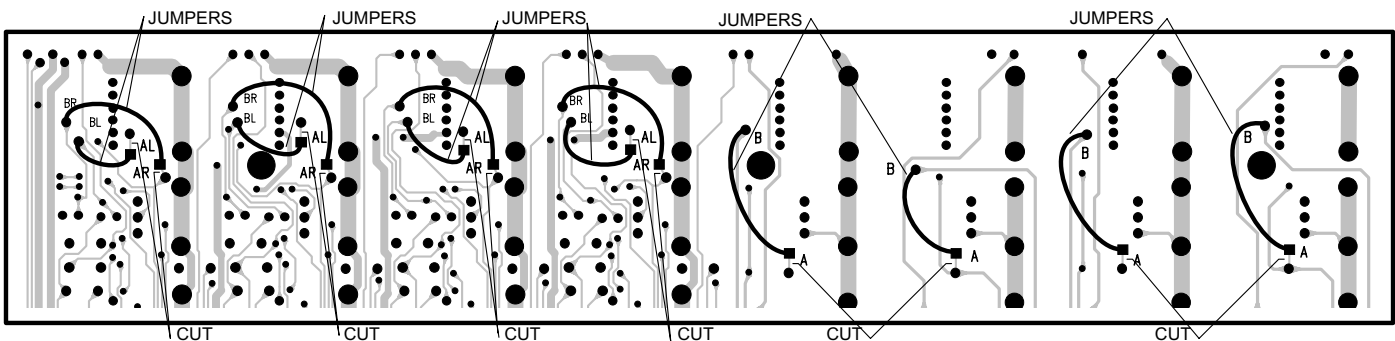

**Pre-Fader Mod**

### Channels 1-4

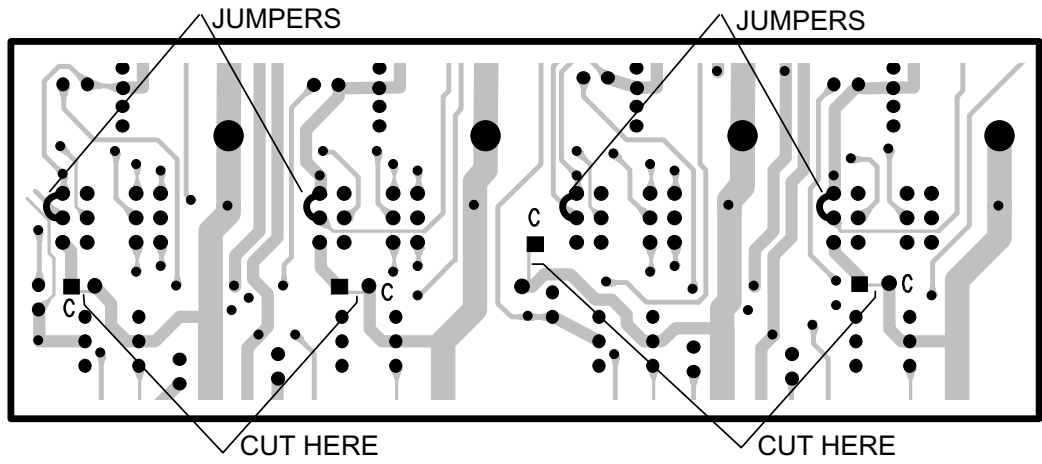

### Channels 5-12

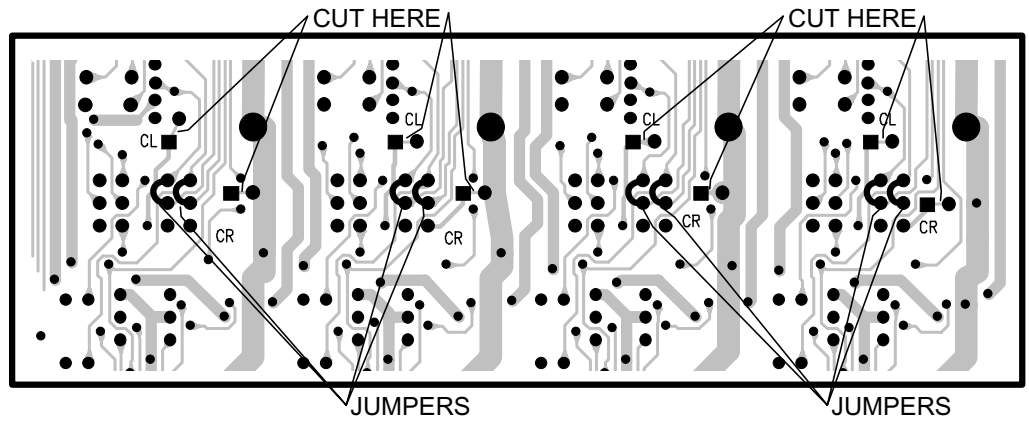

### Pre-Mute Mod

## Main Mix Source Mod

This modification changes the SOURCE matrix's MAIN MIX selection to tap the stereo signal before the MAIN MIX level control (*pre*) instead of after (*post*). This could be especially handy for live work

where the engineer wants to be able to control the MAIN MIX level (sent to the house system) without changing the level in his headphones. The work area is on the underside of the circuit board, near the MAIN MIX level control.

**Caution:** This modification also causes the meters to indicate pre MAIN MIX levels. They will no longer indicate the signal level at the MAIN OUTS, but rather the signal level at the PHONES and CONTROL ROOM outputs (when MAIN MIX SOURCE is selected).

1. Remove all cords, including the power cable, from the 1202-VLZ PRO.
2. Place the mixer upside-down on a dry, non-marring surface.
3. Remove the screws that attach the bottom cover. Keep track of what screws go where. Remove the bottom cover.
4. Using a sharp "X-acto" type knife, cut the conductor at points 'XL' and 'XR'. Be careful to cut all the way through the conductor, and do not cut any nearby traces.
5. Add a jumper from point 'YL' to the square pad at point 'XL' and from point 'YR' to the square pad at point 'XR'.
6. Check your work very carefully, then put the bottom cover back the way you found it. You're done!

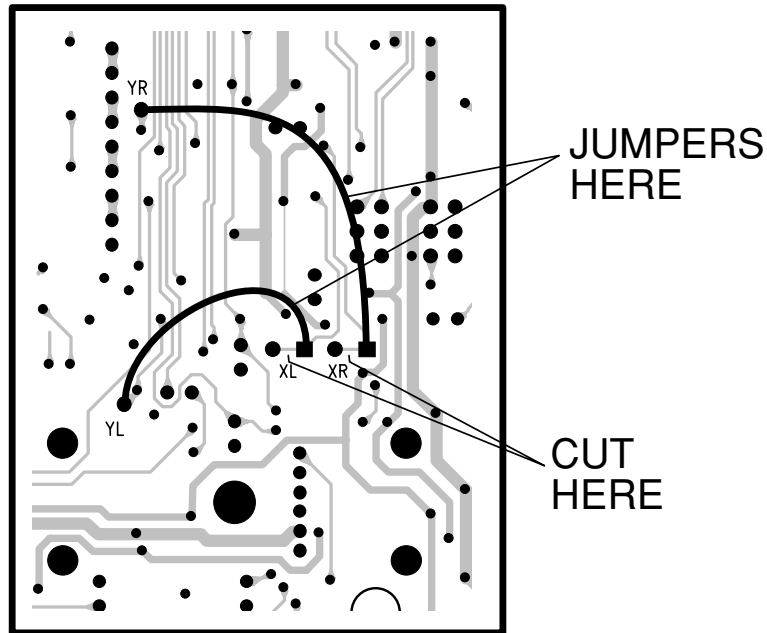

# 1402-VLZ PRO Modifications

## Pre-Fader Mod (Aux To Monitor)

This modification changes AUX SEND 2 to be *pre-fader, pre-mute* instead of *post-fader, post-mute*. (“Mute” refers to the channel’s MUTE/ALT 3-4 switch.) In order to convert the entire mixer, it must be done on each channel, and is slightly more involved for the stereo channels 7-14. The work area is on the underside of the circuit board, near the channel AUX SEND knobs.

1. Remove all cords, including the power cable, from the 1402-VLZ PRO.
2. Place the mixer upside-down on a dry, non-marring surface.

3. Remove the screws that attach the bottom cover. Keep track of what screws go where. Remove the bottom cover.
4. Using a sharp “X-acto” type knife, cut the conductor at point ‘A’ (channels 1-6) or the conductors at points ‘AL’ and ‘AR’ (channels 7-14). Be careful to cut all the way through the conductor, and do not cut any nearby traces.
5. Add a jumper from point ‘B’ to the square pad at point ‘A’ (channels 1-6) or from points ‘BL’ to ‘AL’ and ‘BR’ to ‘AR’ (channels 7-14).
6. Repeat for all channels.
7. Check your work very carefully, then put the bottom cover back the way you found it. You’re done!

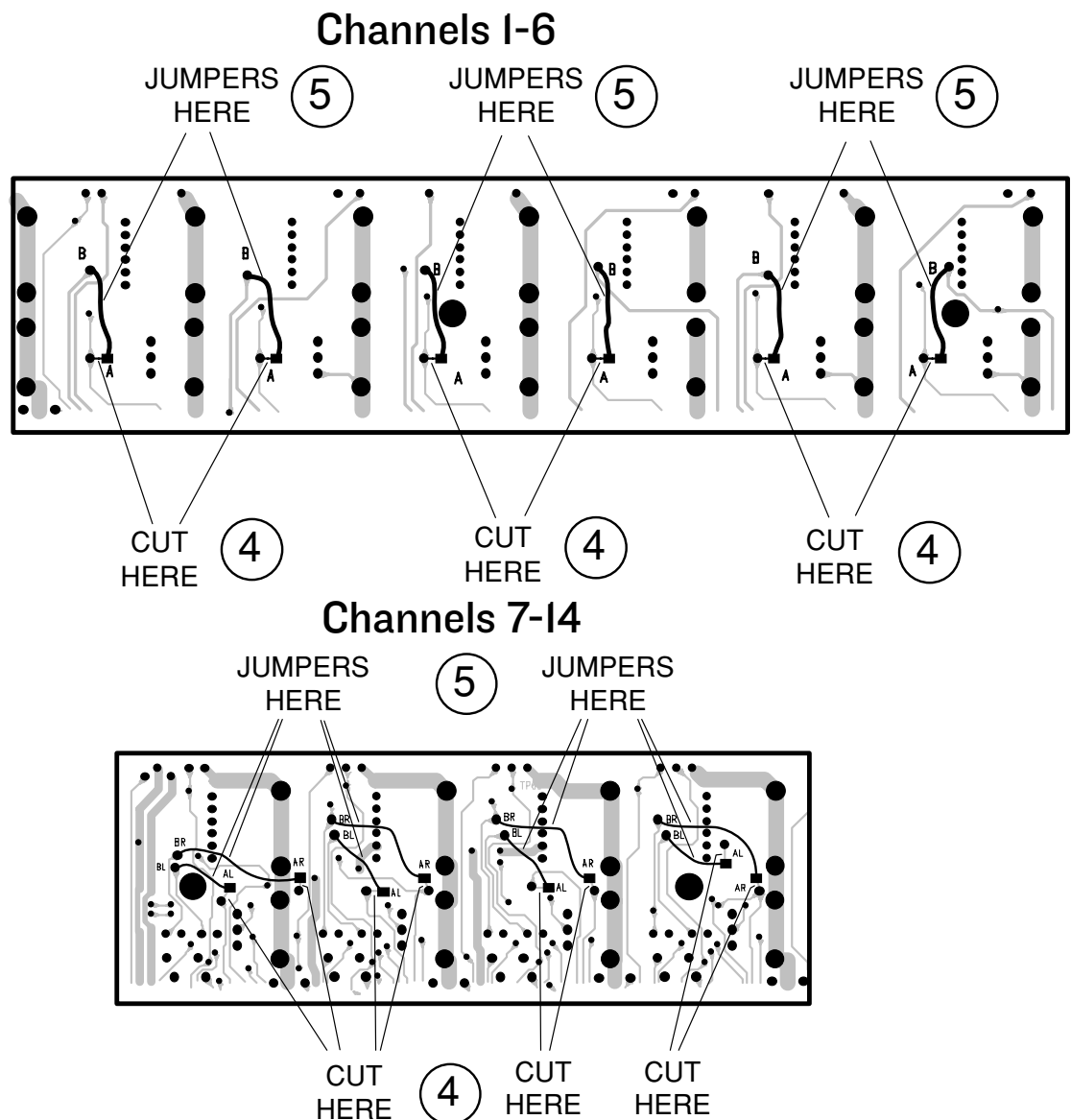

## Pre-Mute Mod

This modification changes AUX SEND 1 (in *post* mode) and AUX SEND 2 to receive signal regardless of the channel's MUTE/ALT 3-4 switch position, but still be *post-fader*. In order to convert the entire mixer, it must be done on each channel, and is slightly more involved for the stereo channels 7-14. The work area is on the underside of the circuit board, near the channel MUTE/ALT 3-4 switches.

1. Remove all cords, including the power cable, from the 1402-VLZPRO.
2. Place the mixer upside-down on a dry, non-marring surface.
3. Remove the screws that attach the bottom cover. Keep track of what screws go where. Remove the bottom cover.
4. Using a sharp "X-acto" type knife, cut the conductor at point 'C' (channels 1-6) or the conductors at points 'CL' and 'CR' (channels 7-14). Be careful to cut all the way through the conductor, and do not cut any nearby traces.
5. Locate the 12 pins that comprise the underside of each MUTE/ALT 3-4 switch.
6. Add jumpers as shown on the illustration below—they're not specifically marked on the circuit board itself, so be careful.
7. Repeat for all channels.
8. Check your work very carefully, then put the bottom cover back the way you found it. You're done!

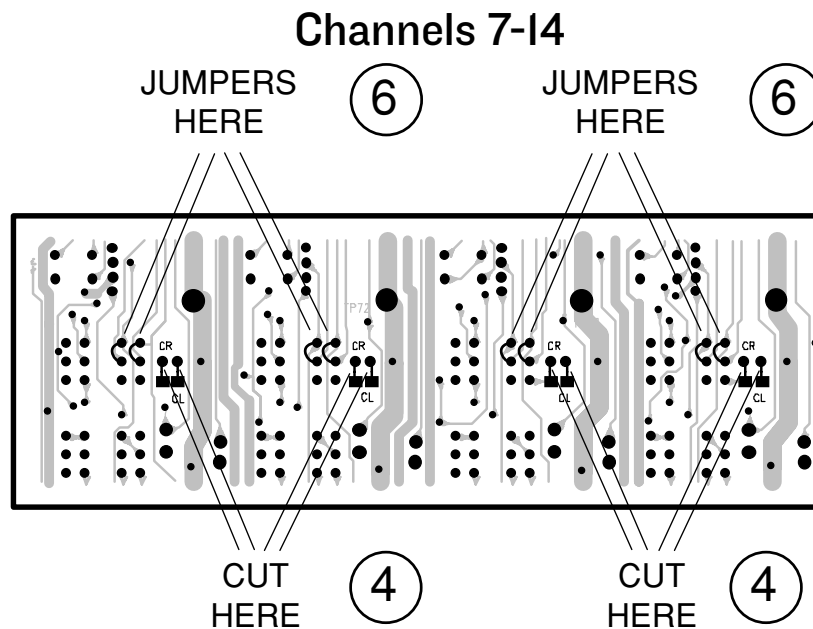
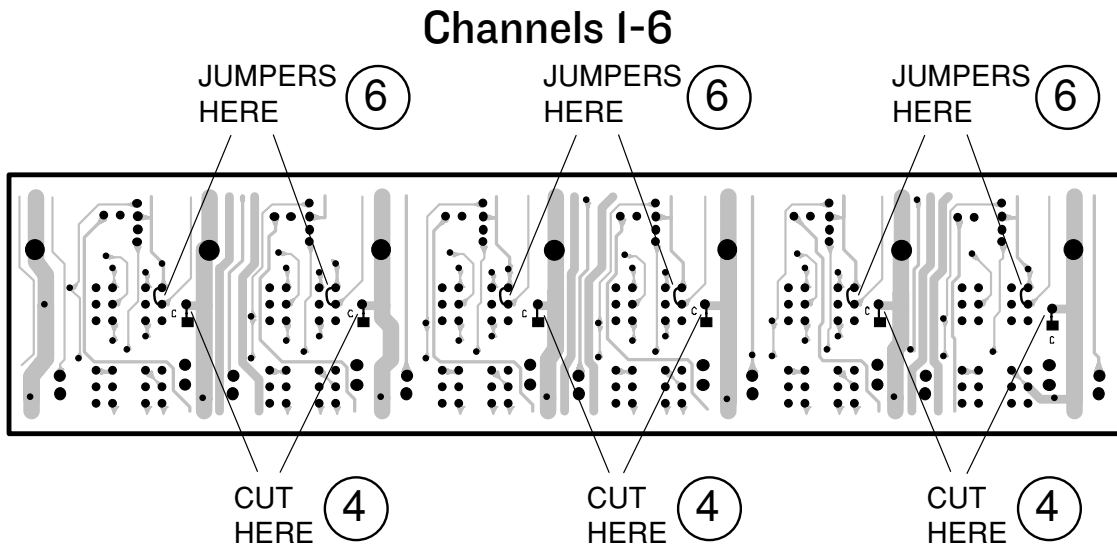

## Main Mix Source Mod

This modification changes the SOURCE matrix's MAIN MIX selection to tap the stereo signal before the MAIN MIX level control (*pre*) instead of after (*post*). This could be especially handy for live work where the engineer wants to be able to control the MAIN MIX level (sent to the house system) without changing the level in his headphones. The work area is on the underside of the circuit board, near the MAIN MIX level control.

**Caution:** This modification also causes the meters to indicate pre MAIN MIX levels. They will not longer indicate the signal level at the MAIN OUTS, but rather the signal level at the PHONES and CONTROL ROOM outputs (when MAIN MIX SOURCE is selected).

1. Remove all cords, including the power cable, from the 1402-VLZ PRO.
2. Place the mixer upside-down on a dry, non-marring surface.
3. Remove the screws that attach the bottom cover. Keep track of what screws go where. Remove the bottom cover.
4. Using a sharp "X-acto" type knife, cut the conductor at points 'XL' and 'XR'. Be careful to cut all the way through the conductor, and do not cut any nearby traces.
5. Add a jumper from point 'YL' to the square pad at point 'XL' and from point 'YR' to the square pad at point 'XR'.
6. Check your work very carefully, then put the bottom cover back the way you found it. You're done!

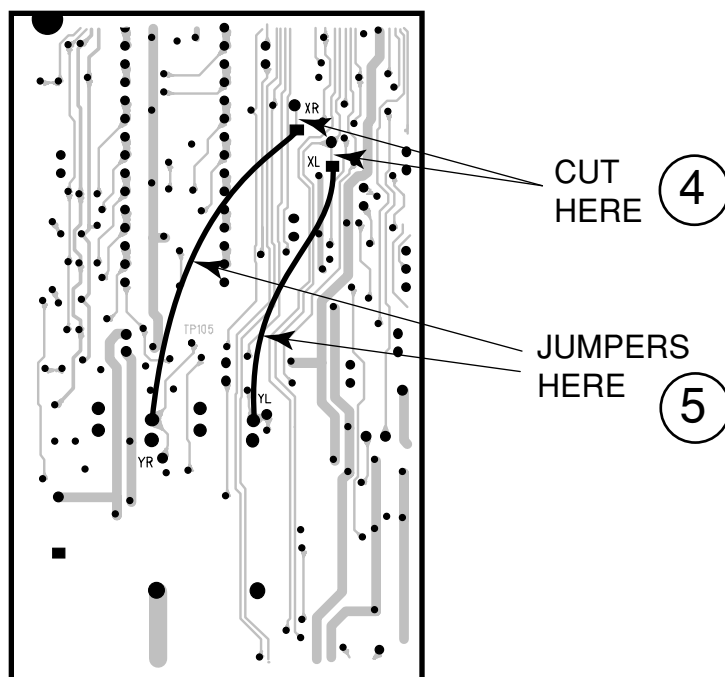



# 1604-VLZ PRO Modifications

## 1604-VLZPRO Post-EQ Mod

This changes AUX SENDS 1 and 2, with the pre switch engaged, to receive their signals *post*-EQ instead of *pre*-EQ. The signal remains post-low cut, pre-mute and pre-fader. With the pre switch disengaged (up), the signals are not affected by the mod. The following must be performed for each channel you wish to modify:

1. Remove all cords, including the power cable, from the 1604-VLZ PRO.
2. Place the mixer upside-down on a dry, non-marring surface.
3. If you have converted your mixer to the rack-mount position or have installed a RotoPod, undo those changes and temporarily configure the mixer in the original desktop mode. You do not have to install the pod, just get it out of the way of the bottom cover.

4. Remove the screws that attach the bottom cover. Keep track of what screws go where. Remove the bottom cover.
5. Cut the conductor at point C, between the square and round pads. Be careful to cut all the way through the conductor, and do not cut any nearby traces. Each channel is slightly different, but this graphic shows Channel 16, which is very different from the others, and Channel 15 (respectively), which is similar to the remaining channels.
6. Add a jumper from the square pad at point B to the square pad at point C.
7. Repeat for each channel you wish to modify.
8. Check your work very carefully, then put the bottom cover back the way you found it. You're done!

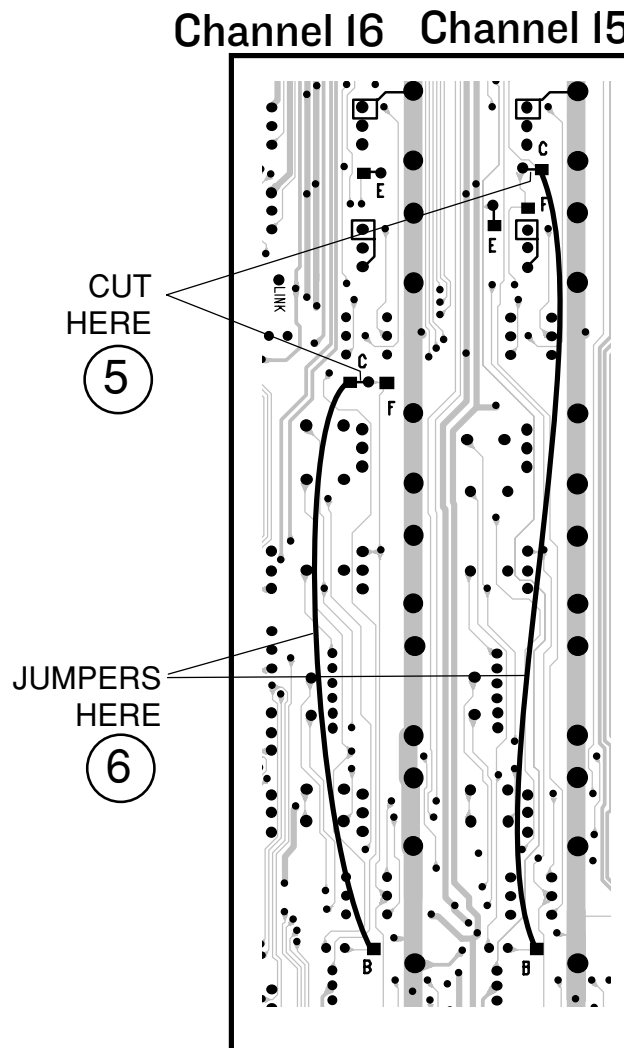

## 1604-VLZPRO Source Mod

This changes the CTL ROOM/PHONES level control in the SOURCE matrix to receive the main mix stereo signal *pre*-MAIN MIX fader instead of *post*-MAIN MIX fader.

You can accomplish the same result that this modification provides by using two standard 1/4" tip-sleeve "jumper cables" plugged into the MAIN INSERT (L and R) to the *first click* and the other end plugged into STEREO AUX RETURN 4, assigned to C-R/PHNS ONLY. STEREO AUX RETURN 4 level will control the volume as well as CTL ROOM/PHONES level control.

You can also use the TAPE INPUT (L and R) RCA jacks (you will need 1/4" to RCA cables or adapters) and assign the TAPE source button in the SOURCE matrix.

1. Remove all cords, including the power cable, from the 1604-VLZPRO.
2. Undo the PHONES nut.
3. Place the mixer upside-down on a dry, non-marring surface.

4. If you have converted your mixer to the rack-mount position or have installed a RotoPod, undo those changes and temporarily configure the mixer in the original desktop mode. You do not have to install the pod, just get it out of the way of the bottom cover.
5. Remove the screws that attach the bottom cover. Keep track of what screws go where. Remove the bottom cover.
6. Move the PHONES board to one side so you can get to points YL and YR marked on the board.
7. Cut the conductor at points ZL and ZR, between the square and round pads. Be careful to cut all the way through the conductor, and do not cut any nearby traces.
8. Add a jumper from the square pad at point YL to the square pad at point ZL and another from the square pad at point YR to the square pad at point ZR.
9. Check your work very carefully, then put the Phono board and nut, and bottom cover back the way you found them. You're done!

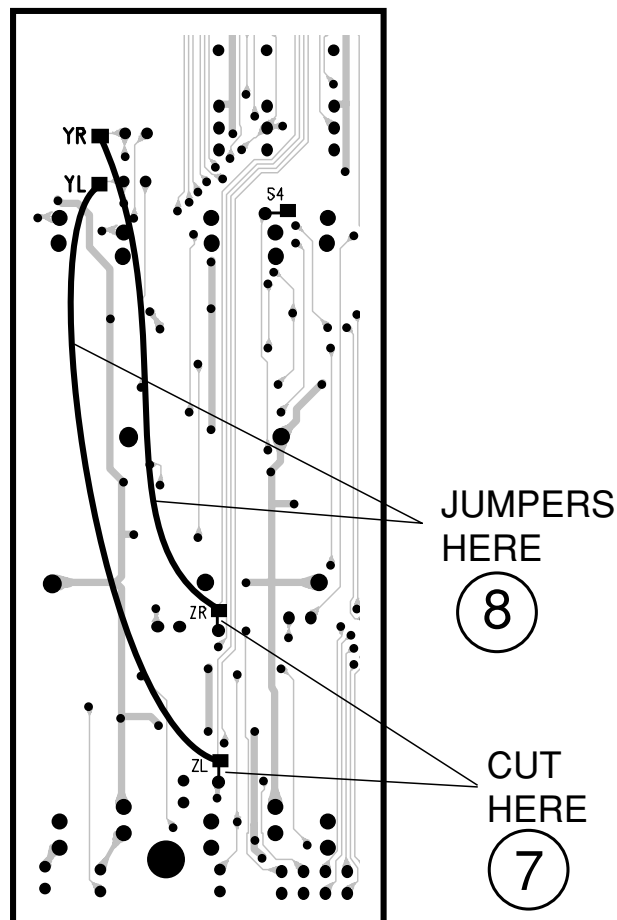

# 8•Bus Modifications

## AUX Send Mod

This modification changes the tap point of all “pre” AUX sends from *post-EQ* to **pre-EQ**. It must be done on each channel. For example, if you have a 24•8, the modification must be done on all 24 input channels.

See Figure below. This modification takes place on each channel strip in an area under the AUX 1/2 Pre/Post switch.

1. Remove power cable.
2. Cut the conductor at Point A.

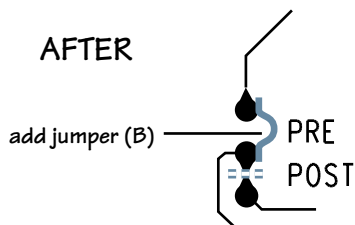
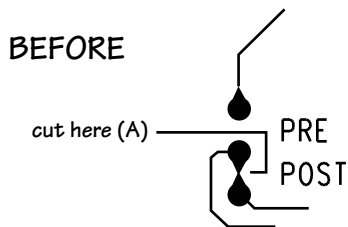
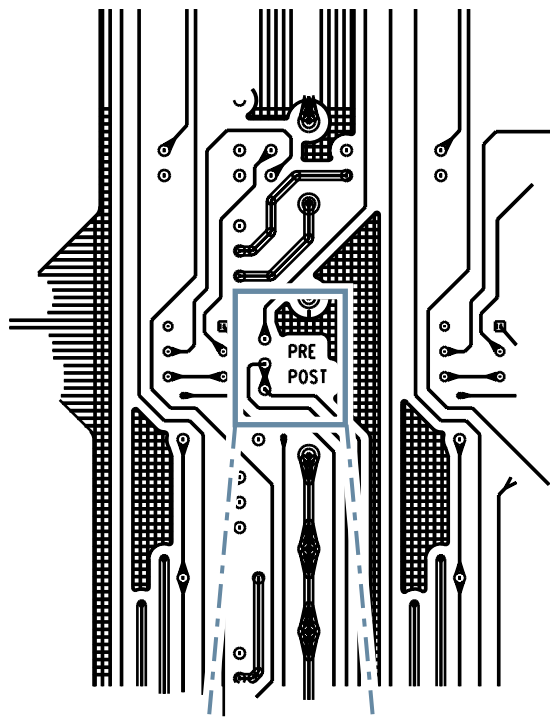

Aux Send Modification

3. Add a jumper at Point B.
4. Repeat for all input channels.

## PFL Mod

This modification changes the tap point of the SOLO bus from *post-fader/post-mute* (stereo) to *pre-fader/pre-mute* (mono). It must be done on each channel. For example, if you have a 24•8, the modification must be done on all 24 input channels.

See Figure below. This modification takes place on each channel strip in an area under the channel fader.

1. Remove power cable.
2. Cut the conductor at Point C.
3. Cut the conductor at Point D.
4. Add a jumper at Point E.
5. Add another jumper at Point F.
6. Repeat for all input channels.

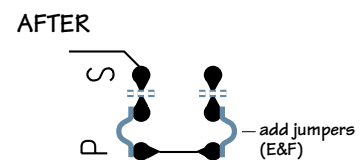
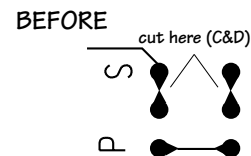
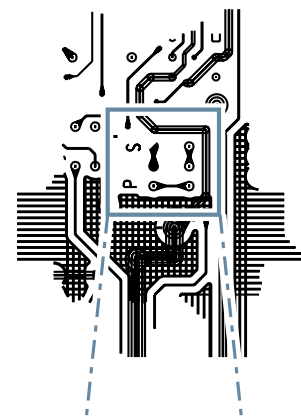

PFL Modification

## Mix-B Source Mod

This modification changes the tap point of the Mix-B Source switch (engaged) from *pre-fader/pre-mute* to *post-fader/post-mute*. It must be done on each channel. For example, if you have a 24•8, the modification must be done on all 24 input channels.

See Figure below. This modification takes place on each channel strip in an area under the Mix-B Source switch.

1. Remove power cable.
2. Cut the conductor at Point G.
3. Add a jumper at Point H.
4. Repeat for all input channels.

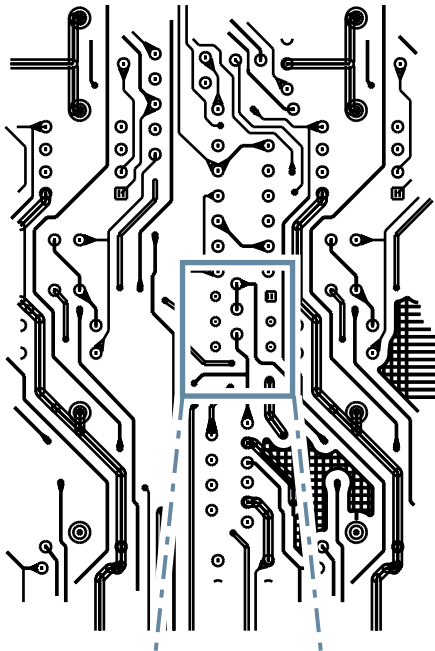

BEFORE

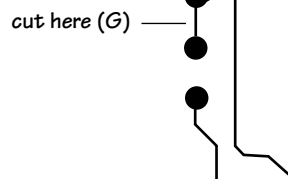

AFTER

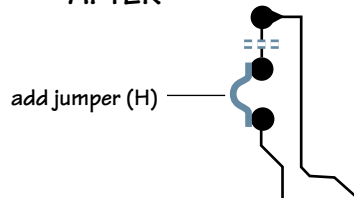

## Mix-B Source Modification

## Mix-B Mute Mod

This modification converts the Mix-B Source switch to a Mix-B MUTE switch. The switch will no longer be able to source the channel signal. This modification must be done on each channel. For example, if you have a 24•8, the modification must be done on all 24 input channels.

See Figures below. This modification takes place on each channel strip in an area under the Mix-B Source switch.

1. Remove power cable.
2. Cut the conductor at Point G.
3. Add Jumper to point H.
4. Repeat for all input channels.

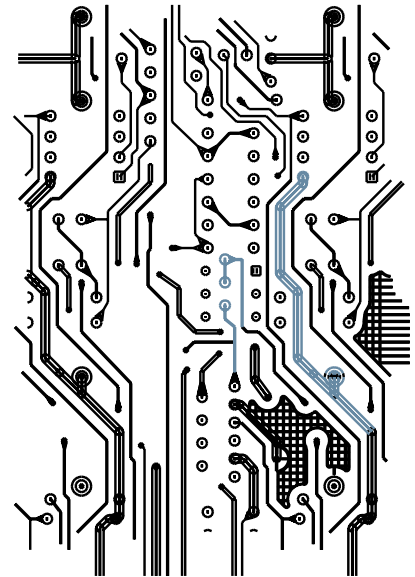

BEFORE

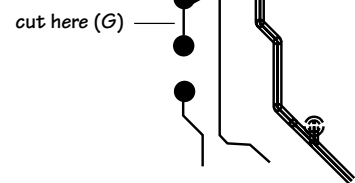

AFTER

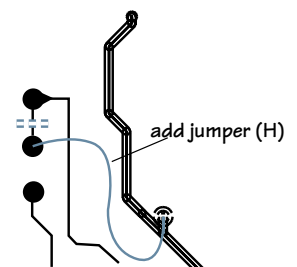

## Mix-B Mute Modification

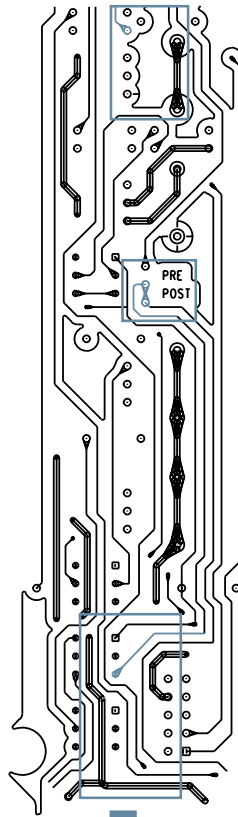

BEFORE

AFTER

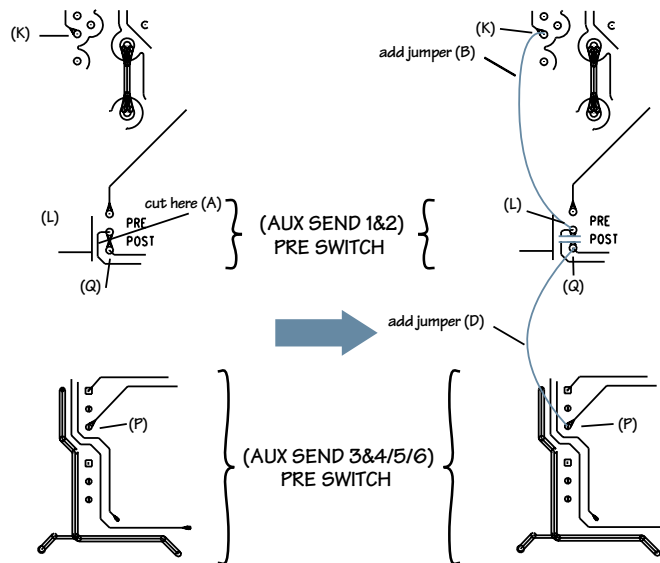

The infamous and dreaded but-if-we-hadn't-included-it-we'd-just-have-to-fax-it-to-the-foolhardy-anyway modification

### AUX 1/2 Source Mod



This modification should only be performed if the console is being used strictly for recording.

- A. When the Aux 1/2 Pre Switch is engaged, Aux Send 1 and 2 will tap the Pre-Fader information from the tape returns.

- B. When the Aux 1/2 Pre Switch is *not* engaged, Aux Send 1 and 2 function normally, as post fader channel sends.

All that said, here's the mod.

See Figure above. This modification takes place on each channel strip in the area under the AUX 3/4 Mix-V Source switch and also under and near the AUX 1/2 PRE switch.

1. Remove power cord.
2. Cut two (2) traces at point (A).

Note: The wire used in the next three steps should be 24-28 gauge insulated jumper wire.

Do not strip off any more insulation than is absolutely necessary.

3. Add a 1-1/2" jumper (B), connected at points K and L.
4. Add a 2-1/4" jumper (D), connected at points P and Q.



“Mackie.” and the “Running Man” figure are registered trademarks of LOUD Technologies Inc.

©2003 LOUD Technologies Inc.  
All Rights Reserved.

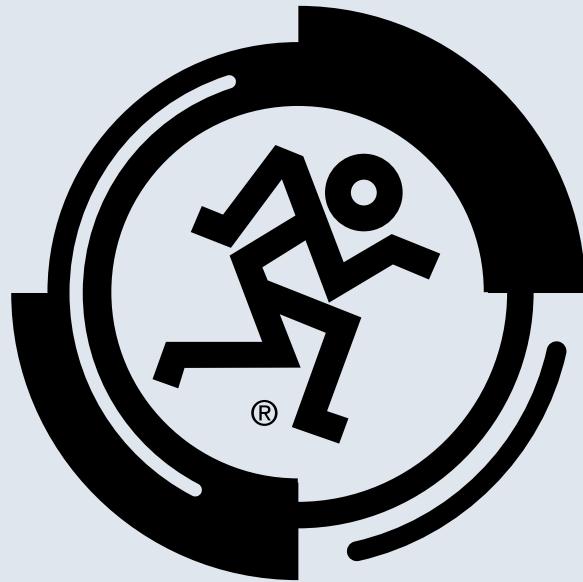

**MACKIE®**

**LOUD Technologies Inc.**

16220 Wood-Red Road NE • Woodinville, WA 98072 • USA

US and Canada: 800.898.3211

Europe, Asia, Central and South America: 425.487.4333

Middle East and Africa: 31.20.654.4000

Fax: 425.487.4337 • [www.mackie.com](http://www.mackie.com)

E-mail: [sales@mackie.com](mailto:sales@mackie.com)